

WHITE BOOK

on the

**Future of Low-Energy
Nuclear Physics in Poland**

and the

**Development of the
National Research Infrastructure**

Editors:

A. Maj, K. Rusek,
P. Bednarczyk, J. Dudek, B. Fornal, M. Kicińska-Habior,
S. Kistryn, M. Lewitowicz, T. Matulewicz, W. Nazarewicz,
W. Satuła, J. Skalski, J. Srebrny, E. Stephan, W.H. Trzaska

Section of Nuclear Physics of the Polish Physical Society (SFJ-PTF)
Heavy Ion Laboratory, Warsaw University (HIL)
Institute of Nuclear Physics Polish Academy of Sciences, Kraków (IFJ PAN)

WHITE BOOK

on the

Future of Low-Energy Nuclear Physics in Poland

and the

Development of the National Research Infrastructure

Editors:

**A. Maj, K. Rusek,
P. Bednarczyk, J. Dudek, B. Fornal, M. Kicińska-Habior,
S. Kistryn, M. Lewitowicz, T. Matulewicz, W. Nazarewicz,
W. Satuła, J. Skalski, J. Srebrny, E. Stephan, W.H. Trzaska**

Kraków/Warszawa September 2020



Participants in “The future of low-energy nuclear physics in Poland and the development of national research infrastructure” conference.

Photo taken in front of the HIL building on January 14, 2019 by W.H. Trzaska.

Technical Editors:

Adam Maj, Marzena Wolińska-Cichocka
e-mails: adam.maj@ifj.edu.pl, mala@slcj.uw.edu.pl

Cover design:

Jerzy Grębosz
(Cover photo - thanks to The NASA Hubble Space Telescope)

ISBN 978-83-959188-0-3

Contents

Contents	3
1. Executive Summary	5
2. Theory of nuclear structure and dynamics	8
2.1 Few-body systems and nuclear interactions	10
2.2 The atomic nucleus as an open quantum system	12
2.3 Physics of isospin and fundamental symmetry tests in $N\sim Z$ nuclei	15
2.4 Nuclear dynamics from time-dependent DFT: induced fission and pairing dynamics	17
2.5 Challenges for nuclear theory at the intersections of nuclear and other fields of physics	19
2.6 Final remarks	24
3. Polish Research Infrastructures – status and perspectives	26
3.1 Poland in the European Nuclear Physics Landscape	27
3.2 The Heavy Ion Laboratory of the University of Warsaw	28
3.3 Cyclotron Centre Bronowice	32
3.4 Nuclear Physics at Extremely Low Energies: A Small Accelerator System under Ultra High Vacuum Conditions	38
3.5 The MARIA research reactor with the Interdisciplinary Laboratory of Materials and Biomedical Research	41
4. Superheavy Elements	47
4.1 Super Heavy Elements - experimental opportunities for HIL?	48
4.2 Research on Super Heavy Elements in Poland - Theoretical perspective	49
4.3 Recoil separators for studies of super-heavy nuclei	50
4.4 High-K states in heaviest nuclei	51
4.5 Chemistry of superheavy elements	52
5. Mechanisms of nuclear reactions in simple and complex systems	54
5.1 Direct Reactions at Stable Beam Facilities	56
5.2 Dynamics of fission in phenomenological models	57
5.3 FAZIA - Status, Perspectives for Installation and Possible Physics Case in Poland	59
5.4 Barrier distributions	60
5.5 Few-body reactions	61
5.6 Nuclear spallation	62
6. Gamma spectroscopy	64
6.1 AGATA -Advanced Gamma Tracking Aray	66
6.2 NEDA - NEutron Detector Array	67

6.3 ULESE - University of Lodz Electron SpEctrometer	68
6.4 Plunger for lifetime measurements in inverse kinematics reactions	69
6.5 Lifetime determinations with fast timing scintillators and g-factor measurements.	70
6.6 Nuclear structure studied with Coulomb excitation.....	71
7. From isomers to giant resonances.....	74
7.1 High-spin state nuclear phenomena	77
7.2 Isomers in Exotic Nuclei.....	78
7.3 K shape isomers in the secondary potential well of heavy nuclei –experimental perspectives.....	79
7.4 PARIS – status, perspectives for installation in Poland and studies of hot rotating nuclei.....	81
7.5 Giant Resonances built on cold nuclei.....	84
7.6 Experimental studies of the strength function below the binding energy.....	86
7.7 Decay of “stretched” states in the continuum	87
7.8 Fast timing beta-delayed γ -ray spectroscopy	88
7.9 γ -ray spectroscopy of fission products with a Gas-Filled Magnet.....	89
8. Nuclear Physics Applications	91
8.1 CERAD@NCBJ.....	93
8.2 Materials studies	94
8.3 Neutrons in interdisciplinary and nuclear studies	94
8.4 Prompt gamma imaging for online monitoring in proton therapy - the SiFi-CC project	95
8.5 Application of nuclear physics in studies of discrete symmetries, quantum entanglement and positronium imaging with the J-PET tomograph	100
8.6 How to test electronics used in Space?	101
8.7 Testing the response of detectors with high-energy protons at CCB.....	104
8.8 Challenges in radiobiology research with heavy ion beams in Poland.....	105
8.9 Outlook for the production of radioisotopes and radiopharmaceuticals at HIL	108
8.10 ENSAR2-Nuclear Physics Innovation and Enterprise Europe Network activity for transfer technology and knowledge between nuclear laboratories and industry	111
Author index	113
Annex 1. Program of the conference	114

Chapter 1

Executive Summary

A. Maj

The H. Niewodniczański Institute of Nuclear Physics PAN, Kraków, Poland

and

K. Rusek

Heavy Ion Laboratory, University of Warsaw, Warsaw, Poland

This Report presents the status and perspectives of low-energy nuclear physics research in Poland. It has become a tradition that the society of Polish nuclear physicists periodically summarizes the community's achievements and draws up plans for the future. The very first such report was prepared by a team of scientists led by Professor Jerzy Jastrzębski and published by the Polish Nuclear Physics Network under the title "Nuclear Physics in Poland 1996-2006". The next one, entitled "Long-Range Plan of Polish Nuclear Physics in the years 2007-2016" was prepared by the Commission of Nuclear Physics, the Advisory Board of the National Atomic Energy Agency of Poland. The team of editors was led by Professor Jan Styczeń. A few years later, this Commission, led this time by Professor Krzysztof Rusek, published the "Long-Range Plan of Polish Nuclear Physics and Nuclear Methods, 2010-2020".

The present Report is the result of a two-day conference entitled "The future of low-energy nuclear physics in Poland and the development of national research infrastructure"¹ held at the Heavy Ion Laboratory of the University of Warsaw (HIL UW)² on 14-15 January 2019. The conference was organized by the Nuclear Physics Section of the Polish Physical Society³, HIL UW and the Institute of Nuclear Physics Polish Academy of Sciences (IFJ PAN)⁴ in Kraków. The main goal of the conference was to integrate the community of Polish nuclear physicists around research in nuclear physics which may be carried out in Poland either in the near future or in the long-term, as well as the presentation of plans for the development of the national research infrastructure in Poland for low energy nuclear physics. The scientific program⁵ and the choice of invited speakers (see Annex 1) was determined by the International Program Committee (IPC), chaired by Professor Adam Maj (IFJ PAN). The IPC consisted of acknowledged Polish scientists from Poland and abroad: J. Andrzejewski (University of Łódź), P. Bednarczyk (IFJ PAN), J. Dudek (CNRS Strasbourg), B. Fornal (IFJ PAN), St. Kistryn (Jagiellonian University), M. Kowal (National Centre for Nuclear Research, NCBJ), M. Lewitowicz (GANIL, the Nuclear Physics European Collaboration Committee NuPECC), W. Nazarewicz (Michigan State University), P. Olko (IFJ PAN), M. Pfützner (University of Warsaw, UW), M. Płoszajczak (GANIL), K. Rykaczewski (Oak Ridge), T. Rząca-Urban (UW), W. Satuła (UW), J. Skalski (NCBJ), W.H. Trzaska (University of Jyväskylä), and M. Warda (M. Curie-Skłodowska University).

1 <http://slcj.uw.edu.pl/pl/konferencja-slcjecos/>

2 <http://slcj.uw.edu.pl>

3 <http://sfj-ptf.slcj.uw.edu.pl>

4 <https://www.ifj.edu.pl>

5 <http://slcj.uw.edu.pl/pl/konferencja-slcjecos/program/>

The IPC decided to divide the program into seven topical sessions. The conveners for each session were responsible for proposing appropriate speakers. The selected topics comprised the theory of nuclear structure and dynamics (convened by W. Satuła); the status of Polish research infrastructures (M. Kicińska-Habior and M. Lewitowicz); superheavy elements (J. Skalski); the mechanism of nuclear reactions (St. Kistryn and E. Stephan); gamma-ray spectroscopy (J. Srebrny and P. Bednarczyk); isomers and giant resonances (J. Dudek and B. Fornal); and applications of nuclear physics (T. Matulewicz and W.H. Trzaska).

The conference turned out to be a true community event: 116 participants attended this two-day meeting, among them a large number of junior nuclear physicists (PhD students and postdoctoral fellows), representing 20 institutions. In total, 52 papers and 12 posters were presented. It is worth noting that the majority of the presentations were given by junior scientists. The poster session was a lively event coordinated by T. Rząca-Urban, M. Kmiecik and J. Andrzejewski. The conference demonstrated that there exists a strong and multi-disciplinary nuclear science community in Poland. The presentations contained many new ideas, both theoretical and experimental, for science and projects at the existing and/or planned infrastructures. The importance of societal applications of nuclear physics was emphasized.

An important session was devoted to Polish nuclear physics research infrastructures, both available and planned. The following existing infrastructures were presented: the Cyclotron Centre Bronowice at the IFJ PAN in Krakow; the infrastructures at NCBJ in Świerk; the eLBRUS laboratory at the University of Szczecin; and the Heavy Ion Laboratory of the University of Warsaw. Concerning future plans, in the next few years HIL UW plans to replace the operating U-200P cyclotron with a new one. This would ensure a higher intensity of ion beams with better energy parameters as well as an extended variety of beams. This project has been called “HIL@ECOS”, with reference to the European ECOS project from the FP7 EURONS program, recommended by NuPECC. “HIL@ECOS” has received support from NuPECC, the Joint Institute of Nuclear Research in Dubna, as well as from numerous Polish institutions.

Based on the presentations and discussion, it is highly desirable that the new infrastructure projects are:

- sufficiently ambitious to attract a large part of the Polish nuclear physics community;
- attractive for international collaborations and ... funding agencies;
- attractive for the younger generation of Polish nuclear physicists;
- multi-disciplinary, with an appreciable component of applied sciences;
- able to provide an important component dedicated to education and training (universities & nuclear energy);
- capable of providing sufficient beamtime (ensure running costs!) for a wide range of ions and energies.

This White Book intends to summarize the main scientific arguments and conclusions presented during the Conference for the needs of the development of the nuclear physics research infrastructure in Poland. Obviously, there are no direct recipes on how to fund the planned developments, but at least the Conference provided a good deal of ammunition that will be useful when applying for resources. And, importantly, the Conference highlighted the strong involvement of Polish nuclear physicists working abroad and the tremendous potential of the young generation of Polish nuclear physicists.

The success of the low-energy nuclear physics community meeting, documented in the present White Book, resulted in another community meeting on September 28th, 2020, held virtually via the internet, an Open Meeting⁶ of the Section of Nuclear Physics of the Polish Physical Society (SFJ PTF). Its main purpose was to exchange information on the number and status of Polish teams conducting research in broadly understood nuclear physics (low and intermediate energy) and its applications. Representatives of the main research centers gave short talks presenting the research teams working in these institutions and their areas of activity, as well as existing or planned infrastructure. This virtual meeting was attended by almost 100 participants who actively participated in the open discussion at the end of the meeting.

The Editors of this Report wish to thank all the authors for their efforts and collaboration. Special thanks are given to dr. Marzena Wolińska-Cichocka from HIL for great editorial help, to dr. Jerzy Grębosz from IFJ PAN for designing the cover page graphics and to dr. Nick Keeley from NCBJ for improving the English. Financial support from HIL for organizing the conference and printing this White Book is appreciated.

Kraków/Warszawa, September 2020

6 <http://sfj-ptf.slcej.uw.edu.pl/otwarte-zebranie-sekcji/>

Chapter 2

Theory of nuclear structure and dynamics

Convener
W. Satuła

Faculty of Physics, University of Warsaw, Warsaw, Poland

Based on contributions by:

Y. Jaganathen (*Institute of Nuclear Physics PAN, Kraków*), P. Magierski (*Warsaw University of Technology*), M. Płoszajczak (*GANIL, France*), W. Satuła (*University of Warsaw*), R. Skibiński (*Jagiellonian University, Krakow*), G. Wlazłowski (*Warsaw University of Technology*)

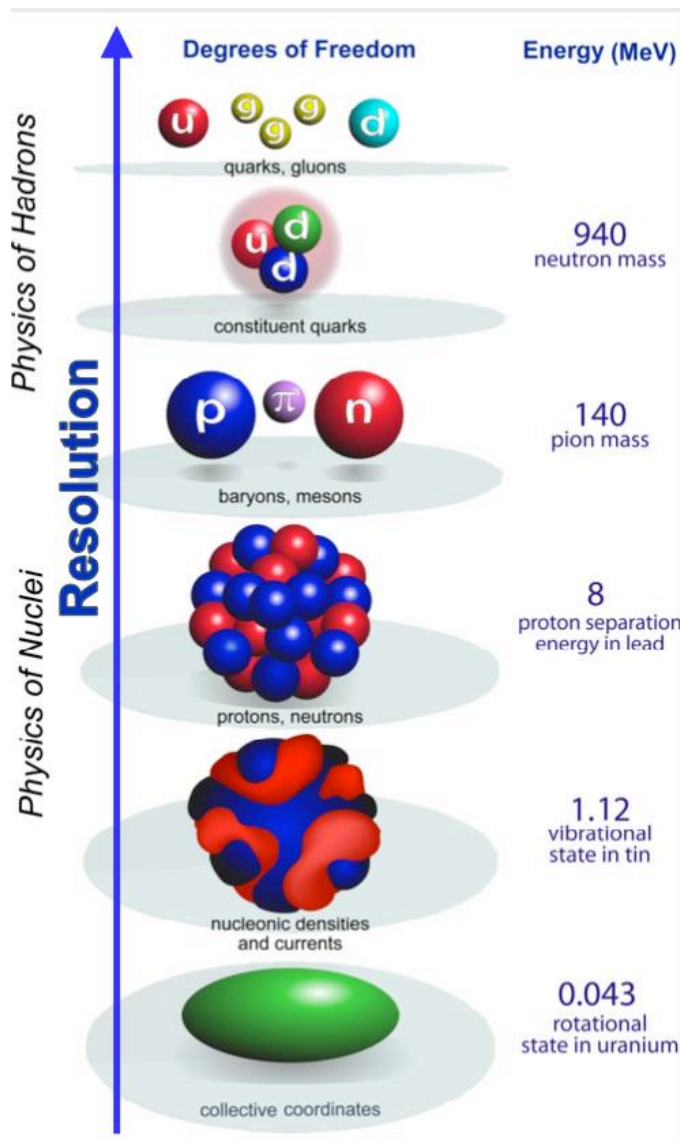

Fig.1 Nuclear degrees of freedom [Courtesy of W. Nazarewicz]

The atomic nucleus is a self-organized, many-body quantum system that emerges from complex interactions between quarks and gluons on a scale of femtometers. At low energies, the quark and gluon degrees of freedom are invisible or, as physicists used to say, not resolvable, and the nucleus is seen as an aggregation of point-like neutrons and protons held together by the short-range nuclear force. In spite of this simplification, nuclei remain exceedingly difficult to describe computationally, posing a challenge for theory. The complexity of the nuclear many-body problem makes the development of a single theoretical model applicable to the entire Segre chart extremely, if not prohibitively, difficult. Hence, models based on different assumptions and working at different resolution scales have been developed and are currently used to interpret and predict.

The major nuclear theory frameworks can be divided into four classes depending on the choice of degrees of freedom as sketched in Figure 1. At the top of the hierarchy of models are the so-called ab-initio approaches. They combine state-of-

the-art many-body techniques with a modern theory of inter-nucleon interactions constructed according to the rules of effective field theory (EFT). The low-energy coupling constants (LECs) of EFT are usually adjusted to two- and three-body data, and selected information on heavier nuclei. The next in the hierarchy is the nuclear shell-model (SM) which is a configuration-interaction technique that uses effective two-body NN interactions tailored to a given valence space. Historically, the nuclear SM has provided the foundation of modern nuclear theory and helped to understand a large amount of data on nuclear levels, moments, collective excitations, and various kinds of decays.

Density functional theory (DFT) is an ab-initio formalism developed for electrons in solids and molecules. Its nuclear variant is the method of choice to compute complex medium-mass and heavy nuclei. Its central idea is to reduce the number of degrees of freedom by replacing the point-like nucleons (neutrons and protons) by their densities and currents. Description of excitations involving coherent motion of many nucleons allows for even further reduction of the number of degrees of freedom to a limited number of collective variables.

Atomic nuclei are complex quantum many-body systems. The intricate nature of the interaction between the nucleons, the role of three- and higher-body forces, the subtleties resulting from the interplay between short- (hadronic) and long-range (Coulomb) forces, all make the solution of the nuclear quantum-many body problem truly challenging. Furthermore, in the atomic nucleus energy scales corresponding to the single particle and collective degrees of freedom are often intertwined, which leads to a variety of phenomena and strongly complicates the theoretical description, making accurate predictions difficult. No comprehensive theory of the atomic nucleus exists. Our knowledge of nuclear properties has been built gradually using models of different degrees of sophistication (or different resolution) whose parameters are tuned to reproduce experimental data. It is unavoidable that future progress in understanding nuclear properties will occur at the interface between advanced theoretical modelling and experiment. In that sense, an adequate uncertainty quantification of theoretical results becomes an acute methodological problem of great importance.

As already mentioned, the last two decades mark unprecedented progress in developing both the EFT-based approaches to the nuclear interaction as well as many-body techniques used to solve the many-body Schrödinger equation. The field has evolved from Green's Function Monte-Carlo calculations to the coupled cluster (CC) formalism, the no-core shell model (NCSM), the no-core Gamow shell model (NCGSM), the in-medium similarity renormalization group (IMSRG), and the Self-consistent Green's function method, which allows us to push the borders of nuclear ab-initio computing towards heavier and more exotic nuclei.

In parallel, there has also been great progress in the unification of nuclear structure and nuclear reaction theory. This work has led, for example, to the no-core shell model coupled to the resonating-group method (NCSM/RGM) and the NCGSM used for calculating continuum properties, such as the properties of resonances and scattering cross sections. Further developments of the shell model embedded in the continuum (SMEC) and the Gamow shell model (GSM), which are modern realizations of the continuum shell model (CSM), allow for a microscopic description of near-threshold clustering phenomena and two-proton radioactivity using realistic SM interactions. The deeper understanding of nuclear properties which is provided by the SM for open quantum systems defines new

territory for spectroscopic studies which extends from the drip lines to the region of stable nuclei for states in the vicinity and above the first particle emission threshold. Systematic studies in this broad region of masses and excitation energies will extend and complete our knowledge of atomic nuclei at the limits of stability. Another significant theoretical achievement consisted in developing the Time Dependent Density Functional Theory (TDDFT) with the inclusion of pairing correlations which is known as the Time Dependent Superfluid Local Density Approximation (TDSLDA). This allows for microscopic treatment of nuclear reactions involving medium or heavy nuclei, where pairing correlations and, in particular, pairing field dynamics play an important role. It has been successfully applied to the description of induced nuclear fission, as well as the dynamics of nuclear matter in neutron star crusts.

Remarkable progress has also been achieved in developing DFT-rooted models, especially no-core configuration interaction (NCCI) approaches based on multi-reference DFT (MR-DFT) which nowadays offer an interesting alternative to the conventional nuclear shell model. Indeed, these models are capable of treating rigorously both the fundamental (angular momentum, particle number) as well as approximate (isospin) symmetries of the nuclear Hamiltonian. Moreover, by invoking the multi-reference description, they allow important correlations to be incorporated into the nuclear wave function in a controlled way.

2.1 Few-body systems and nuclear interactions

Quantum chromodynamics (QCD) provides first principles for nuclear physics. At the low energies typical for atomic nuclei QCD is non-perturbative and, hence, the direct evaluation of nuclear properties must rely on lattice QCD calculations. First applications of lattice QCD to fundamental constants, such as g_A , hadron masses, and the properties of the lightest nuclei, are extremely promising. Still, many applications rely on a controlled transition to the physical pion mass/small lattice spacing limit, which is often not easy.

Among various field-theoretic approaches to inter-nucleon forces, the most promising is chiral effective field theory (χ EFT) which is based on the symmetries of QCD, in particular on the broken chiral symmetry with the pion being a Goldstone boson. χ EFT attempts to provide a systematic low-momentum expansion to a given order in momentum transfer, with nucleons and pions as degrees of freedom. At present, χ EFT is not yet fully satisfactory because the theory is not properly regularized and exhibits a spurious dependence on cut-offs. Moreover, the ordering of terms in the low-momentum expansion is still debated. But efforts to resolve these difficulties continue.

Nuclear reactions at low and medium energies are extensively studied to understand the underlying interactions between nucleons and between nucleons and external electroweak probes, as well as to clarify reaction mechanisms. Significant progress in theoretical methods has been made in recent years, and new many-body approaches have been applied to describe nuclear reactions, especially with few-nucleon systems. Currently the main focus is on an explanation of various aspects concerning both the nuclear interactions and the electroweak current operators pertinent to the theoretical formalisms, e.g., on studying the validity of approximations used in the more phenomenological theoretical models. Progress in these investigations requires dedicated experimental programs on few-body systems that are crucial for constraining various aspects of nuclear theory.

- Polarization observables are necessary to establish detailed properties of nuclear forces and currents. This concerns both two-nucleon, three-nucleon as well as many-nucleon systems, as many-body forces become progressively more important with increasing number of nucleons. According to our current knowledge, the spin-dependence of many-body forces is strong and the structure of corresponding operators is complex. Hence, precise measurements of spin observables in few- and many-nucleon systems are important. In this context, it is worth noting that only a few polarization observables, typically at single energies, have been measured for many-nucleon systems. The precision of the existing data in many cases is too limited to constrain modern theoretical approaches. The same problem is present when it comes to the electroweak sector, where the studies of current operators suffer from lack of precise data, again especially for processes with polarization degrees of freedom.
- The complexity of the nuclear Hamiltonian and reaction mechanisms call for a systematic study of reactions/observables. First of all, the dependence on the initial energy of the system has to be clarified. Secondly, usually various final states are possible and the opportunity to study these states in a single experiment (with the same detection system) is valuable. The charge dependence of nuclear forces and currents (especially many-body ones) is one of the questions which will be studied in coming years, so the measurement of isospin-complementary reactions is important. Finally, to understand the role of many-body forces and currents as well as correlations between nucleons in heavier systems, experiments should carry out systematic studies in systems with different numbers of nucleons.
- Nuclear reactions often lead to final states with many free nuclei/particles and the associated reaction phase spaces can be rich. Consequently, future detection systems should aim at covering as much of the phase space as possible (4π -type detection systems) to study different interaction components.

Interesting developments are related to the application of various renormalization group methods to solving the nuclear many-body problem and providing tractable schemes for deriving nuclear interactions. The renormalization group approach has been used to project nuclear interactions onto a low-momentum subspace, which become useful for many-body calculations. The similarity renormalization group approach provides a flow of unitary transformations to simplify the structure of the original Hamiltonian in a suitable representation. Decoupling of low- and high-momenta which enabled many-body calculations in smaller Hilbert spaces, results in induced higher rank interactions appearing that make numerical calculations extremely difficult. The IMSRG approach aims at the evolution of the Hamiltonian to achieve the desired decoupling, re-shuffling correlations in the Hamiltonian, or decoupling the effective core- and valence-spaces. The latter scheme allows us to demonstrate how the successful phenomenological SM or CSM may arise from the ab-initio many-body frameworks such NCSM or NCGSM.

Another insight into the in-medium NN interaction is provided by the dispersive optical model (DOM) analysis of the neutron/proton elastic cross section, spectral functions and charge distributions. Detailed DOM analyses of neutron/proton scattering data on ^{40}Ca and ^{48}Ca showed that protons (neutrons) experience stronger (weaker) correlations in neutron-rich matter. Existing experimental information on the asymmetry dependence of the central potential is still meager and systematic efforts, both experimental and theoretical, over long isotopic chains are of great importance for understanding the in-medium interaction of nucleons far from the valley of beta stability towards the drip lines.

In our quest for a comprehensive model of the atomic nucleus it is important to develop new strategies to describe both nuclear structure and reactions within a unified framework. To this end, important progress has been achieved using the NCSM/RGM, NCGSM and the coupled-channel GSM (GSM-CC) approaches which do not rely on the concept of the optical model to describe the scattering of light systems. Recently, the optical model has been constructed using the ab-initio CC approach and applied to describe the low-energy elastic scattering of neutrons on $^{40,48}\text{Ca}$. It was found that the CC optical potential has a much too small imaginary part and therefore the ab-initio construction of a microscopic optical potential with the correct absorption properties poses a considerable challenge.

2.2 The atomic nucleus as an open quantum system

The conventional shell model describes the nucleus as a closed quantum system where nucleons occupy bound, well localized single-particle (s.p.) orbits and are isolated from the environment of scattering states. The first open quantum system formulation of the nuclear SM, respecting unitarity at the particle emission threshold(s), was achieved in the GSM. The many-body states of the GSM are the linear combination of Slater determinants defined in the Berggren ensemble of s.p. states which includes bound states, resonances and complex energy scattering states along the respective contours in the complex momentum plane. Reaction channels are not explicitly identified in this approach so the GSM is primarily a tool for spectroscopic studies of bound and unbound states and their decay.

The solution of an eigenvalue problem involving the continuum states is an acute numerical problem. As in the standard SM, the dimension of the many-body valence space increases dramatically with the number of valence nucleons and the size of the s.p. basis. In GSM, each s.p. state of the discretized scattering contour becomes a new shell in the many-body calculation. To achieve convergent results, the density matrix renormalization group (DMRG) approach, first introduced to overcome the limitations of the Wilson-type renormalization group to describe strongly correlated lattice systems, has been extended to non-Hermitian systems and applied to solve the configuration-interaction problem of the GSM. As the properties of shells in the non-resonant continuum vary smoothly along the scattering contour, the GSM+DMRG approach is well suited to optimize the size of the scattering space and help achieve completeness in GSM calculations.

For the description of scattering properties and reactions, the entrance and exit reaction channels have to be identified. This can be achieved in GSM by expressing wave functions in the complete basis of the reaction channels. The resulting GSM-CC has been applied to various observables involving one-nucleon reaction channels, such as the excitation function and the proton/neutron elastic/inelastic differential cross-sections or low-energy proton/neutron radiative capture reactions. The extension of the GSM-CC approach to reactions involving cluster reaction channels, such as deuteron or α -particle reaction channels, has been developed as well.

One could ask, why should one care about the continuum couplings in spectroscopic studies? At the limit of nuclear stability with respect to particle emission, i.e., in the vicinity of the particle driplines or near the particle emission threshold in well-bound nuclei, nuclear states belong to a multidimensional network of states interconnected via the coupling to decay channels and scattering states. This network of open quantum system eigenstates

spans a four-dimensional lattice in the space of proton/neutron numbers, excitation energy, and angular momentum. Traditional nuclear structure theory describes the nucleus as a closed quantum system which is separated from the continuum of scattering states and decay channels. States of the closed quantum system belong to the one-dimensional (1D) quantum lattice and, hence, the ensemble of nuclei in the nuclear chart forms a forest of separate 1D networks. It is well known that the properties of quantum or classical networks strongly depend both on the lattice dimension and on the nature of the interaction between different configurations (sites) of the lattice. Therefore, the closed quantum system description of the nuclear states at the edge of stability or in the scattering continuum may be a crooked-mirror reflection of their properties. Indeed, new phenomena unknown in closed quantum systems, such as coalescence of eigenfunctions/eigenvalues, segregation of time scales, near-threshold collectivity and clustering, multichannel effects in cross-section and shell occupancies, breaking of mirror symmetry and isospin symmetry, violation of orthogonal invariance and channel equivalence, etc., are also expected in weakly bound or unbound nuclear states. The open quantum system perspective of atomic nuclei imposes new requirements on experiments, which should not only aim at the understanding of individual states and their decays for a given nucleus, but should also provide the matrix of discrete states and their mutual connections between different neighbouring nuclei — to disclose generic features of domains of the correlated states in different regions of excitation energy and proton/neutron number.

There are many effects that occur near reaction thresholds. These include various kinds of clusterization, continuum-coupling induced collectivization of near-threshold states, halo configurations, changes in shell occupancies and reaction cross-sections, and many others. Salient phenomena are expected to be seen in electromagnetic transitions involving near-threshold states. A spectacular effect of this kind corresponds to the E1 transition in ^{11}Be from the near-threshold $1/2_1^-$ state to the $1/2_1^+$ ground state. Are the γ -selection rules for in- and out-band transitions in the rotational bands built upon resonances the same as in particle-stable states? What is the nature of near-threshold γ -transitions? Are they strongly influenced by the collectivization of SM states via the coupling to the particle emission threshold(s)? These challenging questions should be studied experimentally in great detail.

Understanding the nature of pairing correlations in weakly-bound states and in the continuum is yet another great challenge for nuclear structure and reactions. It has been shown that the $T=1$ pairing correlations are strongly modified by the $T=0$ neutron-proton continuum coupling in odd- Z chains of isotopes if the one-neutron S_n and two-neutron S_{2n} separation energies tend to zero. In this limit, an anti-odd-even staggering of the continuum coupling energy correction leads to a significant decrease of the odd-even staggering while the pair amplitudes remain unchanged. Hence, the blocking mechanism weakens and one finds a gradual transition towards a gapless superconductivity.

Occupation of s.p. shells can be modified in the vicinity of the particle emission threshold. One-nucleon spectroscopic factors exhibit anomalous behavior near neutral particle emission thresholds with a characteristic energy dependence around the threshold, in a complete analogy with the Wigner threshold phenomenon for reaction cross sections. This characteristic behavior of spectroscopic factors, which is absent in the standard SM, is the result of an interplay between discrete resonant states and the non-resonant continuum in the many-body wave function. It is also a direct manifestation of the unitarity of the GSM which is violated in the SM at each consecutive particle emission threshold. Near the charged-particle emission threshold there is no cusp behavior in spectroscopic

factors around the particle emission threshold. This shows that the effective correlations among neutrons and protons which determine the occupancies of s.p. shells act differently depending on whether the state is in the proximity of a neutral- or charged-particle threshold.

This finding has far reaching consequences for the nature of many-body states at the proton and neutron driplines, for the average correlations that protons (neutrons) experience in proton-rich (neutron-rich) matter, and for the structure of states in mirror nuclei. For example, the continuum coupling may lead to a strong reduction of the SM neutron spectroscopic factor in a state with large S_n and small S_p , whereas it is insignificant in the opposite situation of small S_n and large S_p . Hence, the one-nucleon spectroscopic factors depend both on S_n and S_p and their determination in knockout reactions using the standard SM and a reaction theory based on the sudden and eikonal approximations cannot be trusted.

Nuclear clustering is arguably among the most mysterious nuclear phenomena. The classic example is α -cluster states that can be found in the proximity of α -particle decay thresholds. This finding cannot be a consequence of any specific feature of nuclear interactions because then the correlations and clustering in near-threshold states would appear at random in different nuclei and at different excitation energies, which is not the case. Hence, the origin of cluster (correlated) states in the proximity of cluster thresholds must be more general. The interplay between internal configuration mixing by interactions and external configuration mixing via decay channels leads to a new kind of near-threshold collectivity. The point of strongest collectivity is determined by the interplay between the competing forces of repulsion (the Coulomb and centrifugal interactions) and attraction (the continuum coupling interaction). For higher angular momenta ℓ and/or for charged particle decay channels, the extremum of the correlation energy is shifted above the threshold. This mechanism explains why the Hoyle resonance in ^{12}C close to the α -particle emission threshold carries an imprint of [$^8\text{Be}-\alpha$] clustering, whereas the $1/2^-$ resonance in ^{15}F in the vicinity of the two-proton emission threshold and high above the one-proton emission threshold has the structure [$^{13}\text{N}-2p$] and, hence, its one-proton decay width is strongly reduced. The nature of the halo nucleus ^{11}Li and the β -delayed proton emission of the neutron halo ground state of ^{11}Be can be explained by the same mechanism (see various examples of near-threshold states in Fig.2).

The generic phenomenon of near-threshold collectivization in open quantum systems explains why so many states, both on and off the nucleosynthesis path, exist 'fortuitously' close to open channels. One should mention that even though bound multi-neutron systems (e.g., the tetra-neutron) are incompatible with the present understanding of nuclear forces, the multi-neutron correlations may appear in the vicinity of the corresponding multi-neutron emission thresholds and could be seen as a dynamical effect in reaction observables.

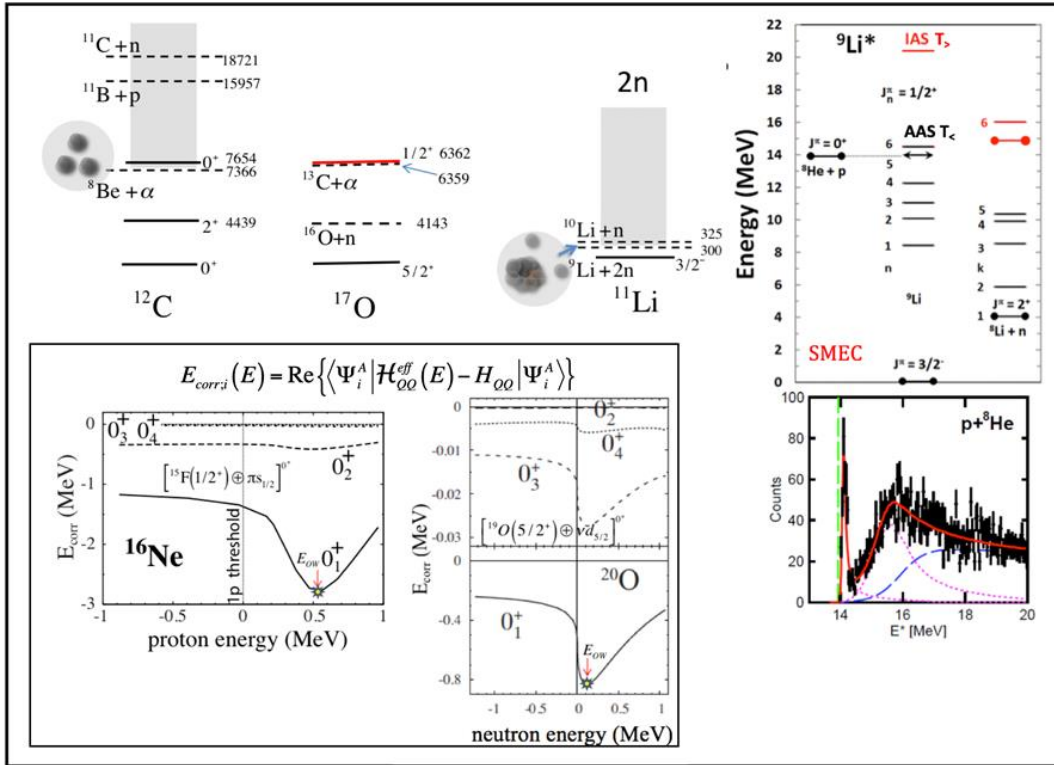

Fig.2 Various examples illustrating the emergence of nuclear clustering in the vicinity of the particle decay threshold. These include: the 0^+_2 Hoyle state in ^{12}C ; the narrow near-threshold $1/2^+_1$ resonance in ^{17}O ; the halo ground state in ^{11}Li ; and the collective splinter of the anti-analog resonance in ^9Li . The insert of this figure shows the continuum-coupling correlation energy as a function of the particle energy in the vicinity of the proton decay channel in ^{16}Ne and the neutron decay channel in ^{20}O . The origin of the energy scale is at the threshold. The arrow points to the centroid of the energy opportunity window to form the aligned eigenstate which carries an imprint of the nearby decay channel. [Adapted from Prog. Theor. Phys. Supplement **196**, 230 (2012) Physics, 120; Acta Phys. Pol. B **45**, 331 (2014); Phys. Rev. C **97**, 044303 (2018)]

At present, the experimental studies of near-threshold collectivization are incomplete. In the past, most studies focused on α -particle clustering whereas similar phenomena are expected at other charged-particle or multi-neutron emission thresholds. Variation of the one-nucleon spectroscopic factors as functions of S_n and S_p and the interpretation of the results of knockout and transfer reactions remain largely unexplored. Near-threshold variations of spectroscopic factors are clear imprints of the openness of the quantum system and mark a radical departure from the standard, unitarity violating SM picture of nuclear structure. They also point to a change in the effective nucleon-nucleon interactions due to continuum coupling and the proximity of the scattering continuum.

2.3 Physics of isospin and fundamental symmetry tests in $N \sim Z$ nuclei

The isospin symmetry of QCD is responsible for the remarkable similarity between the proton-proton, neutron-neutron and neutron-proton strong interactions. The symmetry is widely used in theoretical modeling of atomic nuclei in spite of the fact that it is not a fundamental symmetry of Nature. The physics origin of isospin symmetry breaking (ISB) and its theoretical description depends on the basic constituents of the model, i.e., it is resolution dependent. At the fundamental level of QCD the symmetry is broken by

the different masses and charges of the constituent quarks which are the fundamental building blocks of hadronic matter. At lower energies, where the quarks and gluons are no longer visible, the degrees of freedom reduce to point-like baryons and mesons, see Fig. 1. In this picture, the ISB results from the long-range Coulomb interaction and the short-range ISB strong forces which emerge due to the baryon- and meson-mass splittings, one- and two-meson exchanges and meson-photon exchanges.

Although quarks, the fundamental components of the matter we are all built of, are hidden and cannot appear individually, their indirect signatures are visible through nuclear observables such as atomic masses. The small asymmetry between the neutrons and protons, shifts the masses of the so called mirror nuclei with (N,Z) and (Z,N) neutrons and protons, respectively. These Mirror Displacement Energies (MDEs) as well as more subtle Triplet Displacement Energies (TDEs) which measure binding-energy curvature within isospin triplets, can be calculated using the nuclear DFT. This approach is perfectly tailored to study such ISB effects since it treats the long-range Coulomb polarization properly, without involving an inert core, and it well accounts for the interplay between short- and long-range forces in a self-consistent way. It also allows the inclusion, in a controllable and computationally efficient way, of the ISB contact forces. Moreover, after restoring broken symmetries and implementing configuration mixing, the formalism can be turned into a powerful computational scheme complementary to the conventional nuclear shell-model.

The nuclear DFT extended for ISB terms offers new avenues for studying ISB effects in nuclei. Indeed, with this formalism one can study a broad spectrum of phenomena spanning the range from subtle isospin mixing, through stability of neutron-rich nuclei at the drip lines and the structure and masses of neutron stars to studies of in-medium weak decays.

Of particular interest in the latter context are processes used to search for possible signals of new physics beyond the Standard Model like superallowed $0^+ \rightarrow 0^+$ β -decays. With small, of the order of a percent, theoretical corrections accounting for radiative processes and ISB, these semileptonic pure Fermi decays allow the verification of the conserved vector current (CVC) hypothesis with very high precision and, in turn, provide the most precise values of the strength of the weak force, G_F , and of the leading element, V_{ud} , of the Cabbibo-Kobayashi-Maskawa (CKM) matrix.

The mixed Fermi-Gamow-Teller decays of T=1/2 mirror nuclei offer an alternative for SM tests, provided that the neutrino-beta correlation, beta-asymmetry, or neutrino-asymmetry are also measured. The precision of these experiments is still too low to test the Standard Model but recent progress in β -decay correlation techniques makes these experiments very promising and keeps the field vibrant: see, for example, the recent β -asymmetry measurement in ^{37}K decay. Similar to the superallowed $0^+ \rightarrow 0^+$ Fermi decays, the analysis of T=1/2 transitions and, in particular, the extraction of V_{ud} depends on theoretical estimations of radiative and many-body ISB corrections to the Fermi branch.

The extended DFT formalism can also be used to compute: (i) forbidden unique transitions including both even- and odd-forbidden decays; (ii) matrix elements for allowed double beta decay involving two neutrinos ($2\nu\beta\beta$) and, ultimately, (iii) matrix elements for neutrinoless double beta decay ($0\nu\beta\beta$) which is of paramount importance for experimental $0\nu\beta\beta$ decay searches.

The $0\nu\beta\beta$ decay, if it exists, is expected to be extremely difficult to measure. Its discovery, however, would have profound consequences. It would reveal the nature of neutrinos, solve the neutrino-mass hierarchy problem, and explain the matter-antimatter mystery paving the way for particle theorists to work out extensions of the Standard Model.

2.4 Nuclear dynamics from time-dependent DFT: induced fission and pairing dynamics

Induced fission and collisions at low energies of medium or heavy nuclei are examples of nuclear processes which can be viewed as time evolution involving hundreds of strongly interacting fermions. The inherent feature of these nuclear reactions is superfluidity, which is the key ingredient of their theoretical description, in particular, if non-magic nuclei are involved. A microscopic description of nuclear reactions, rooted in effective nuclear interactions, is a long-standing goal and a problem of great practical and fundamental interest. Its complexity is due to the large number of strongly coupled degrees of freedom which makes this problem computationally challenging. Currently, the superfluid extension of Time Dependent Density Functional Theory (TDDFT) offers the possibility to provide a microscopic description of low energy nuclear reactions. This theoretical framework is known as the Time Dependent Superfluid Local Density Approximation (TDSLDA). Using leadership class computers of hybrid (CPU+GPU) architecture, it has become possible to study real-time 3D dynamics without any symmetry restrictions, evolving up to hundreds of thousands of superfluid fermions. TDDFT represents a qualitative leap in quantum simulations of nonequilibrium systems, allowing us to make quantitative predictions and to reach regimes inaccessible in laboratories.

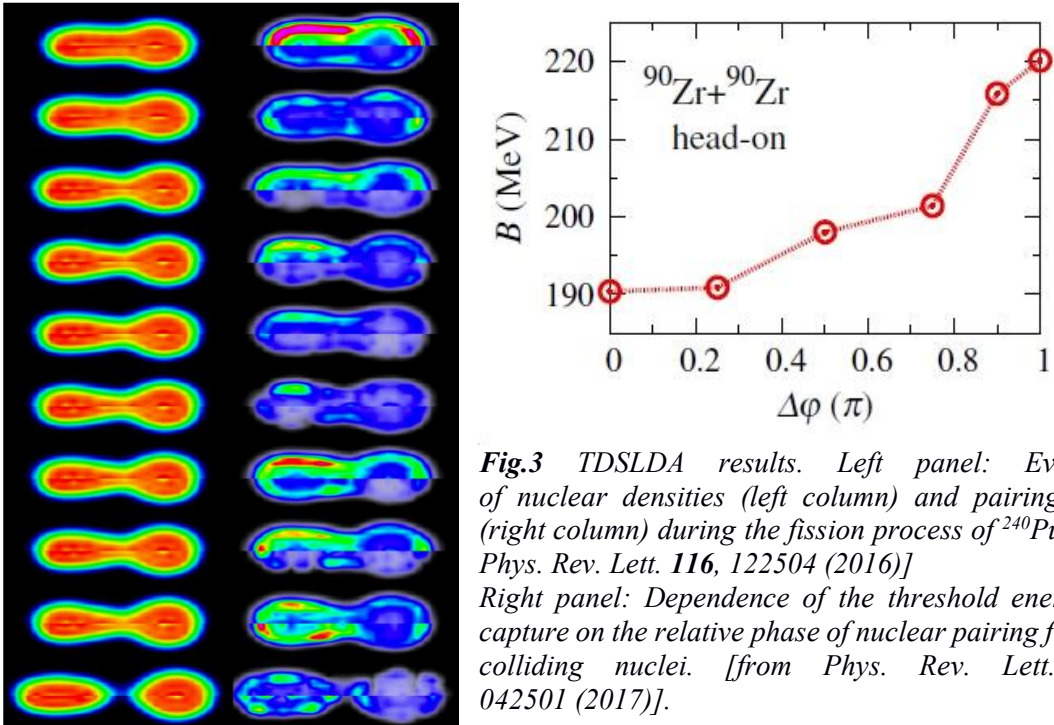

Fig.3 TDSLDA results. Left panel: Evolution of nuclear densities (left column) and pairing fields (right column) during the fission process of ^{240}Pu [from *Phys. Rev. Lett.* **116**, 122504 (2016)]
Right panel: Dependence of the threshold energy for capture on the relative phase of nuclear pairing fields of colliding nuclei. [from *Phys. Rev. Lett.* **119**, 042501 (2017)].

One of the first applications of TDSLDA consisted in modelling the induced fission process of ^{240}Pu , with an excitation energy of about 8 MeV, corresponding to induced fission $^{239}\text{Pu}(n,f)$ with a neutron with an impinging kinetic energy of about 1.5 MeV. In TDSLDA

the system evolves from the initial configuration, choosing the path towards the scission point and beyond, with the final state being composed of the separated fragments. All nucleonic degrees of freedom are active during this evolution and the dynamics of the nuclear pairing field is included. It turned out that the pairing field dynamics is crucial for the description of the process. It oscillates rapidly during nuclear motion, indicating that pairing degrees of freedom are being effectively excited in the process (see Fig.3). It should be emphasized that the fission process modelled within TDSLDA, although slow, is not adiabatic and energy flow from collective to internal degrees of freedom occurs till the scission point is reached. The average atomic mass $AL \approx 105.3$, neutron number $NL \approx 63.5$, and charge $ZL \approx 39.7$ of the light fragment obtained in simulations compare surprisingly well with the systematic data. The light fragment emerged very deformed at scission, with the shape of an axially symmetric ellipsoid with the ratio of the major to the minor axes close to $3/2$. The total number of post-scission neutrons emitted is estimated between 2-3, in reasonable agreement with experiment. The total kinetic energy of the fission fragments as a function of the neutron incident energy agreed surprisingly well with experimental data (the error did not exceed 2%). These findings suggest that TDSLDA may become a promising tool for the study of induced fission.

In order to improve the theoretical description, it is of crucial importance to perform measurements of quantities which can provide unambiguous information about nuclear processes. Below is a list of quantities which are experimentally accessible in the context of induced nuclear fission:

- Mass/charge distributions - key quantities that provide important insights into nuclear dynamics.
- Total kinetic energy (TKE) distributions are determined in the vicinity of the scission point. Therefore, TKE is less sensitive to nuclear dynamics prior to scission.
- Scission neutrons can in principle be extracted in TDDFT. Measurement of scission neutrons can provide a stringent test for the applicability of TDDFT to describe neutron emission in real-time.
- Excitation energy sharing depends on the dynamics and density of states at scission. It can provide a stringent test of TDDFT.
- Primary gamma emission gives important information on the angular momentum distribution of fragments.

The theoretical framework offered by TDSLDA allows for the description of pairing field dynamics in nuclear collisions. Features like solitonic excitations of the pairing field or pairing Higgs mode are examples of phenomena observed in other superfluid systems and they are also expected to occur in nuclear systems. Nevertheless, due to computational complexity, they have rarely been considered to date. It is expected that TDSLDA may help to fill this gap and to relate these effects to nuclear observables, such as capture cross sections and the kinetic and excitation energies of the fragments. The first attempt to use TDSLDA in the context of nuclear collisions was to investigate the excitation of solitons in the nuclear pairing field, induced by its relative phase in colliding nuclei. This exotic excitation mode has been predicted to increase the barrier for capture by several MeV (see Fig.3), which turned out to have observable consequences in the nuclear capture cross section. This effect may serve as an example of the rich physics originating from the evolution of the nuclear pairing field and its coupling to other degrees of freedom. Although it still remains practically unexplored, TDSLDA opens the possibility systematically to investigate these phenomena in collisions of medium and heavy nuclei and it may bring surprising discoveries.

2.5 Challenges for nuclear theory at the intersections of nuclear and other fields of physics

Modeling of neutron stars

The origin of pulsar glitches is still an outstanding mystery. These sudden increases in the rate of spin of neutron stars are thought to be direct manifestations of superfluidity in the stellar interior. These events are generally thought to be due to the superfluid component of the star (neutron matter) decoupling from the “normal” component (mainly protons and electrons) tracked by the electromagnetic emission. The rapid re-coupling of the superfluid condensate leads to a sudden exchange of angular momentum and a glitch. The current picture involves the dynamics of quantized vortices which store a significant amount of angular momentum. As these vortices “creep” through the crust, they transfer their angular momentum into it. Glitches result from a catastrophic release of pinned vorticity that suddenly changes the pulsation rate.

A full solution to the glitching problem will require the relation of the microscopic dynamics of vortices in inhomogeneous nuclear matter to macroscopic hydrodynamics. Relating (nuclear) micro-physics with macroscopic properties is already a challenging problem. The superfluid TDDFT is, to date, the only microscopic method which allows the investigation of the dynamics of fermionic superfluids far from equilibrium. However, in order to apply TDDFT a quantified energy density functional is required which typically is constructed and optimized using selected data provided by terrestrial experiments in nuclear laboratories. Some important data also come from the ultra-cold atomic gases community, where bulk superfluidity in strongly interacting systems is observed directly. Recently, it has been demonstrated that the quantum vortex dynamics in the presence of a nuclear defect (cluster of protons) inside a neutron star crust can be tracked by means of TDDFT. This opened an exciting possibility to provide a microscopic foundation for the glitching phenomenon. Present capabilities of top-tier supercomputers do not allow the execution of simulations that will allow the direct relation of micro-physical results with the macro-scale. Vortex dynamics in the presence of many impurities can be modelled by the semi-classical vortex filament model - a model that was originally developed in the context of quantum turbulence in superfluid helium. This model can be expanded to scales where we no longer resolve impurities and vortices, and thus — after averaging — may provide input for hydrodynamical simulations, see Fig.4. The semi-classical model must firstly be benchmarked against microscopic results.

Correct propagation of information via length scales, starting from microscopic all the way to macroscopic, is fundamental for the physics of neutron stars. Since the process is rooted in the nuclear scale, it is clear that the quality of the nuclear energy density functional, which encodes our understanding of nuclear processes, is of major importance. In the context of the neutron star glitch problem, pairing properties of neutron matter are highly uncertain. Currently, there is not even a consensus regarding the size of the energy gap in pure neutron matter. We believe that nuclear theory efforts pertaining to the better understanding of pairing properties of nuclear systems may have a significant effect on the neutron star community. Terrestrial experiments devoted to studies of pairing effects should not to be restricted to static properties only but also target the impact of superfluid correlations on nuclear dynamics. For example, it has recently been predicted that the dynamics of the pairing field may lead to substantial changes in the reaction dynamics when colliding non-magic nuclei. Experimental observation of such effects would provide an important benchmark for microscopic theories of pairing dynamics.

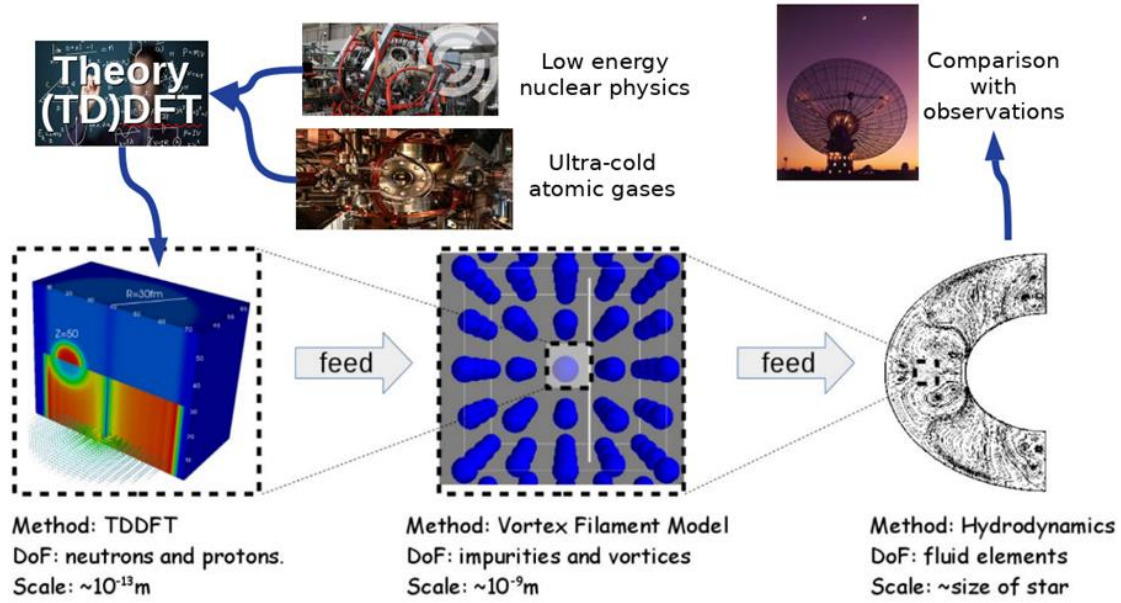

Fig.4 Scheme of the hierarchy of approaches to model the interior of a neutron star. First, microscopic information about the vortex properties, the vortex-nucleus interaction and impurity properties can be extracted from the TDDFT method based on quantified energy density functionals. Next, the vortex filament model is adjusted to these results and is used to extract dynamical vortex properties as it moves through the lattice of impurities (nuclear defects). Averaged results for volumes containing a large number of impurities constitute input for hydrodynamics, the results of which can finally be compared with observations.

Quantum control of nuclear properties

Quantum control of nuclear decays is a longstanding challenge. Changing the lifetime of certain isotopes may have great practical implications for the nuclear waste problem. Nuclei and atoms can be prepared in a well-defined state but they can hardly be tuned. On the contrary, artificial quantum systems, such as quantum dots, or atomic clusters allow wide tunability but the preparation of two identical systems is a very difficult task. Study of nuclear properties in a controlled environment has been attempted in the channeling process of highly stripped nuclei along the crystal axis in the inverse internal conversion of the 73 eV isomeric state of ^{235}U in a laser generated environment, in the isomer excitation in ^{229}Th by intense laser fields, or the collective de-excitation in a Bose-Einstein condensate of ^{135}Cs atoms in their isomeric state using coherent γ -rays.

An excellent example of quantum control is quantum tunneling in a periodically driven multiply degenerate two-level $\text{SU}(2)$ system of fermions (see Fig.5). An exact solution of this system exists for a finite number of fermions N . In the limit of $N \rightarrow \infty$, the exact ground state is given by the $\text{SU}(2)$ coherent states and the dynamics is described by the classical Hamiltonian for a degenerate double-well problem. The degeneracy of positive parity and negative parity ground states is removed by the tunneling of the wave packet in the double-well from one well to another. The periodically driven $\text{SU}(2)$ system can be solved exactly using the energy spectrum of Floquet states which depend on the external environment (driving amplitude and frequency in the studied case) and can be tuned. At the crossing of two Floquet quasi-energies of opposite parity one component of the wave packet is frozen in its initial configuration. By a suitable choice of the driving amplitude

one can extinguish the dominant oscillation frequency of the wave packet and practically freeze the packet in one well. Studies of more realistic periodically driven systems is a challenge to nuclear theory. Would it be possible to freeze the fission process by a suitable choice of an external perturbation? Would it be possible to engineer a fully controllable artificial atomic nucleus?

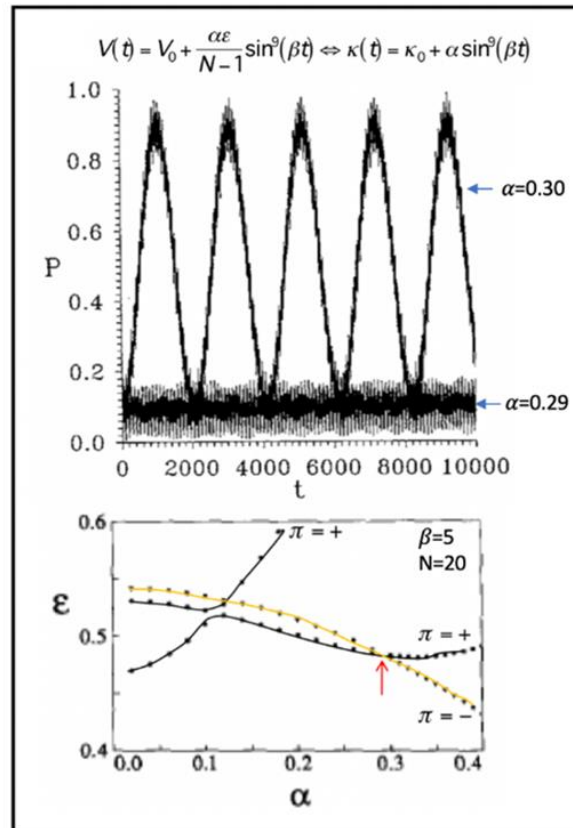

Fig.5 Upper part: Quantum tunneling probability for the initial state, corresponding to the symmetric combination of the pair of first excited nearly degenerate eigenstates of opposite parities which are obtained by diagonalization of the $SU(2)$ Hamiltonian. In this example, $N=20$ fermions are in the presence of external driving with a frequency $\beta=5$ for two amplitudes $\alpha=0.29$ and $\alpha=0.30$. Lower part: Selected Floquet quasienergies of different parity. For $\alpha=0.29$, the positive parity quasienergy state (black line) crosses the negative parity (yellow line) member of the same doublet and leads to a halt in tunneling of the dominant component in the wave function [From Nucl. Phys. A 579, 144 (1994)]

Physics and chemistry beyond the known elements of the Periodic Table

The properties of superheavy atoms and nuclei remain at the forefront of experimental studies in atomic and nuclear physics and chemistry. Since atomic relativistic effects scale approximately with Z^2 , the chemical properties of superheavy elements cannot be properly described by non-relativistic quantum mechanics. Relativistic effects in transactinides are crucial and show up in several ways. Most importantly, s and $p_{1/2}$ atomic orbitals contract relativistically. The shrinking of the inner shells results in an increased screening of the nuclear charge, and this gives rise to an expansion of the $p_{3/2}$ and of higher angular momentum orbitals. Another relativistic effect is a change in the spin-orbit coupling. Both can produce drastic rearrangements of orbital levels. The superheavy elements are believed to experience relativistic effects that are so large that comparison with lighter elements or

non-relativistic results becomes meaningless. In most cases, relativistic effects are more important than electron correlation effects.

Since many properties of superheavy atoms, including their very existence, crucially depend on the properties of their nuclei, answers to the overarching questions require close collaboration between atomic and nuclear theorists. In a recent collaborative effort, electron and nucleon localization functions (dubbed ELF and NLF, respectively) were studied in superheavy systems. These studies demonstrated that the relativistic ELFs for the heavy noble gas atoms Xe and Rn hardly change from the non-relativistic to the 4-component relativistic framework. For the superheavy element Og ($Z=118$), however, theory predicted significant electron delocalization with ELF values that are much smaller compared to the non-relativistic case, making the atomic shell structure barely recognizable. As seen in Figure 6, valence and sub-valence shells of Og are smeared out as in a homogenous electron gas. A similar tendency is seen in the NLFs; this is due to smearing out of nucleonic shell effects in superheavy nuclei.

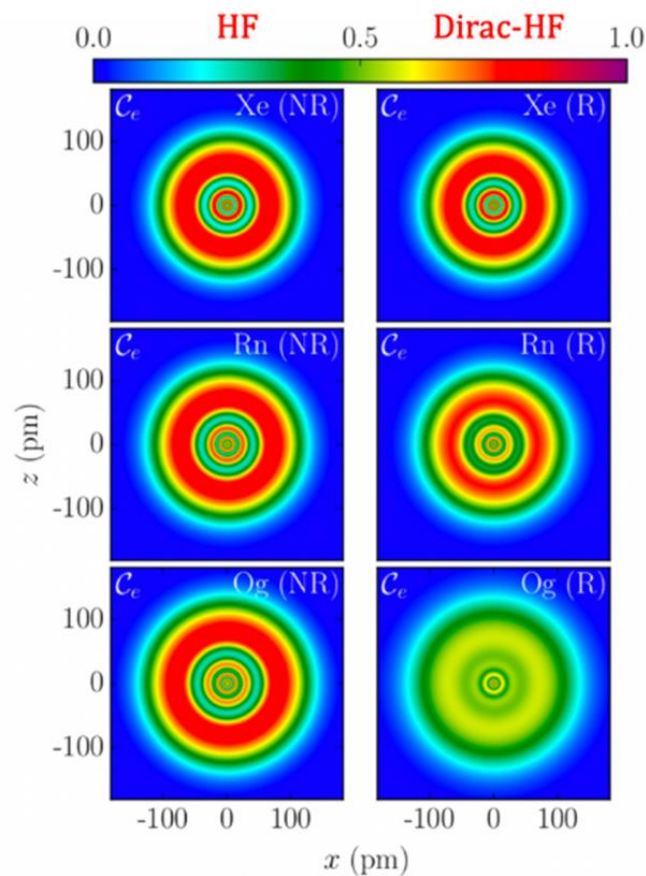

Fig.6 Electronic localization functions from nonrelativistic (NR, left) and Dirac-Hartree-Fock calculations (R, right) for the heavy noble gas atoms Xe (top), Rn (middle), and Og (bottom) [Phys. Rev. Lett. **120**, 053001 (2018)].

DFT calculations with quantified energy density functionals can produce data on properties of superheavy and hyperheavy nuclei, such as charge densities, radii, and deformations, that can be used to provide crucial input for atomic calculations. For instance, electron capture may become important in proton-rich isotopes in the region beyond $Z=120$. At high

nuclear charge the $0s$ state has a substantial portion of its density inside the nucleus, thus increasing the probability for electron capture. This, together with alpha decay and fission, could severely limit the possibility of long-lived nuclides in the region $Z > 120$. Using accurate relativistic electronic wave functions for inner shell electrons and accurate proton and neutron wave functions from our nuclear DFT calculations, one will be able to calculate K-capture rates for superheavy elements up to $Z = 172$.

The current electronic shell structure predictions end at elements with critical nuclear charge $Z_{\text{crit}} \sim 172-173$, where the lowest s level enters the negative energy continuum (supercritical region) as predicted by a mean-field treatment of the Dirac equation. While it is currently unclear how to treat accurately single- or multi-electron systems beyond Z_{crit} , there are no compelling arguments suggesting that Z_{crit} should determine the end of the electronic shell stability and therefore the end of the periodic table. It will be interesting to revisit this question with the help of realistic nuclear input.

Dark matter interactions with nucleons and nuclei

In spite of the undeniable success of the Standard Model of particle physics, vigorous theoretical and experimental studies are currently devoted to identify problems and phenomena that would reveal glimpses of *new physics* beyond the Standard Model (BSM). One of these problems is the interaction of dark matter with nucleons and nuclei. Here, laboratory and underground nuclear physics experiments will provide crucial data.

There are many indirect dynamical effects in astrophysics which imply the existence of dark matter. One of them is the flat rotation velocity curve as a function of the radius r from the center of a galaxy which indicates that the gravitational mass m increases with r . Dark matter is also required to explain the observed pattern of cluster-cluster correlations. Perhaps the most spectacular evidence is seen in the difference between gravitating and radiating matter distributions in the collision of galaxy clusters (see Fig. 7).

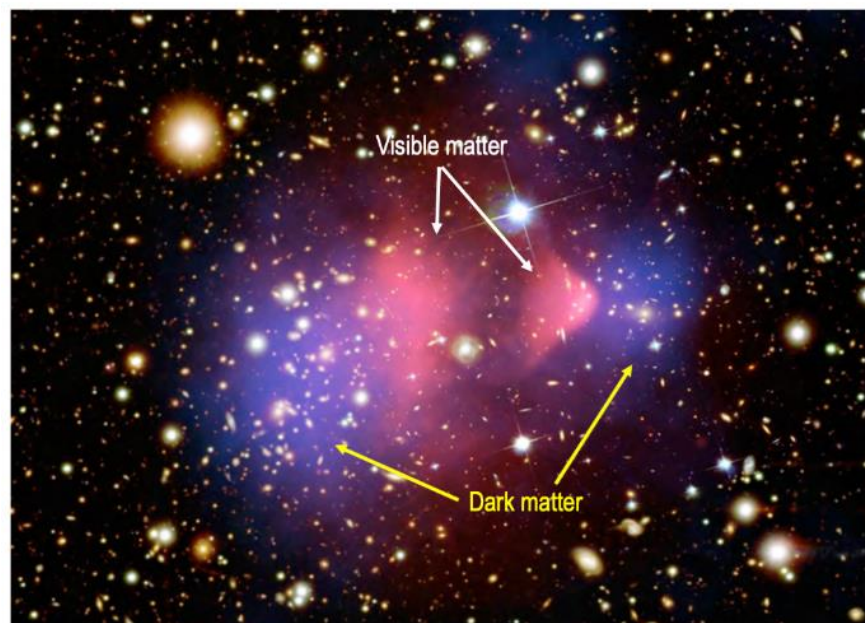

Fig. 7 The Bullet cluster (1E 0657-558): this picture of the collision of two clusters of galaxies, obtained by gravitational lensing, shows a separation between visible and dark matter.

The current consensus is that the bulk of dark matter must have an origin beyond the SM. At present, leading dark matter candidates are weakly interacting massive particles (WIMPs) and axions. Little is known about these particles and their interactions. One believes that they are (i) long-lived or stable; (ii) cold or slow enough to seed the structure formation as seen in cluster-cluster correlations; (iii) gravitationally active; and (iv) should have weak or no coupling to themselves or to baryons. Intense experimental studies are being carried out in collider experiments where one hopes to find WIMPs at energies beyond the mass generation scale of the Standard Model, i.e. 10 GeV - 10 TeV. Indirect astrophysical signals are searched for in the collisions of WIMPs producing Standard Model particles.

The crucial contribution to an understanding of the interaction between WIMPs and nucleons or nuclei will probably be provided by nuclear searches. In the elastic scattering of a WIMP on a nucleon/nucleus one attempts to detect the recoil nucleus. The elastic scattering of a WIMP on a nucleus will depend on nuclear properties and, hence, the world-wide effort to search for the recoiling nuclei in WIMP - nucleus scattering is essential fully to understand the origin of dark matter.

2.6 Final remarks

Theory and experiment are closely intertwined: theory gives the mathematical formulation of our understanding and predictive ability, encoding physical rules and principles, while experiment forces us to create new theories and provides verification of the existing ones. Since the beginning of the century low-energy nuclear theory has made crucial advances which open a new era for nuclear studies. An in-medium nucleon-nucleon interaction has been derived. A number of ab initio many-body approaches have been proposed which now make use of the quantified interactions. The continuum shell model allows us to describe nuclear structure and reactions within a single coherent framework. New multi-reference DFT and TDDFT formalisms have been developed to compute the structure and dynamics of medium-mass and heavy nuclei. Still, tremendous efforts are needed before these conceptual advances will bring real progress in the quantitative description of atomic nuclei.

It took a long time for nuclear theorists to realize the need for uncertainty quantification (UQ) in their predictions. The need for validation, verification, and UQ of computational models that simulate real-world physical processes is in fact a theme that is common to all physical sciences. Indeed, regardless of their underlying mathematical formalism or their intended purpose, complex models share a common feature – *they are not reality*. Consequently, in order to understand the results of computational simulations, we need to understand the associated uncertainties following the best practices for responsible mathematical modelling.

Increasingly, nuclear physics involves statistical inference within complex and computationally intensive theoretical models that combine heterogenous datasets taken at experimental facilities around the world. Modern UQ techniques can enhance the predictive power of theoretical models and optimize knowledge extraction from new measurements and observations. One of the objectives of modern nuclear theory is to use novel statistical methods of UQ to inform near- and medium-term planning for experimental programs at leading nuclear physics facilities. This interweaving of statistical approaches into the dialog

between nuclear physicists and experimental data will accelerate the theory-experiment feedback loop and lead to sustained innovation.

Interdisciplinary research, discoveries and technological progress in nuclear studies raise new challenges and change paradigms and methodologies in nuclear physics studies. Modern nuclear theory is in the mainstream of global science and we should learn how to take advantage of this.

Chapter 3

Polish Research Infrastructures – status and perspectives

Conveners:

M. Kicińska-Habior

Faculty of Physics, University of Warsaw, Warsaw, Poland

and

M. Lewitowicz

NuPECC & GANIL Caen, France

The main nuclear physics infrastructures currently operating in Poland are: the Cyclotron Centre Bronowice at the IFJ PAN in Krakow; the facilities at NCBJ in Świerk; the eLBRUS laboratory at the University of Szczecin; and the Heavy Ion Laboratory of the University of Warsaw. Hundreds of scientists perform their experiments at these facilities. The personnel include physicists, engineers and technicians. Their work has resulted in a significant number of publications in ISI-listed journals and PhD, MSc and BSc theses.

Nuclear physics research teams from Poland cooperate closely with many laboratories around the world, including those in Finland, France, Germany, Italy, Japan, Russia, Switzerland, and the USA. Many Polish nuclear physicists lead innovative projects and perform experiments using accelerator infrastructure in these countries, construct modern instrumentation, and develop software for data acquisition and analysis. They play an important role in developing high-level scientific research, often within national and international collaborations.

Increasingly, researchers from abroad are coming to work in Polish nuclear physics laboratories. Polish nuclear physics facilities offer a high-level scientific working environment, beam time, and unique experimental equipment, such as γ ray detector arrays (EAGLE, HECTOR, PARIS) and charged particle detectors (ICARE, KRATTA, BINA, FAZIA).

The largest Polish nuclear physics facility, HIL UW, is equipped with the only heavy ion cyclotron in central Europe. However, the accelerator is beginning to show its age and in order to propose new top-level scientific projects and to attract young researchers to exciting areas of nuclear physics, a modern stable-ion beam facility at HIL UW, equipped with a new heavy-ion cyclotron, is needed.

This White Book presents the status of the major nuclear physics infrastructures currently operating in Poland from a national and European perspective, and offers a near- and long-term perspective.

3.1 Poland in the European Nuclear Physics Landscape

M. Lewitowicz

NuPECC & GANIL Caen, France

The recent NuPECC 2017 Long Range Plan (LRP) [1] has identified opportunities and priorities for nuclear science in Europe and provided national funding agencies and the European Commission with a framework for coordinated advances in nuclear science in Europe. Ten Polish scientists strongly participated in the whole process of elaboration of the LRP. A summary of the recommendations is included in the figure below.

The major recommendations related to the European nuclear physics facilities may be summarized as follows:

- Complete urgently the construction of the ESFRI flagship FAIR [2] and develop and bring into operation the experimental program of its four scientific pillars APPA, CBM, NUSTAR and PANDA.
- Support for construction, augmentation and exploitation of world leading ISOL facilities in Europe towards EURISOL (GANIL-SPIRAL2 - ALTO, ISOLDE, SPES, ISOL@MYRRHA and JYFL) unifying their efforts via EURISOL – Distributed Facility initiative.
- Support for the full exploitation of existing and emerging facilities (ELI-NP in Bucharest, NICA and the SHE Factory in Dubna).



- Support for ALICE and the heavy-ion program at the LHC with the planned experimental upgrades.
- Support the completion of the AGATA gamma array in full geometry.

All the above-mentioned facilities benefit from important scientific, technical and often financial contributions by Polish research institutions and collaborations. As examples one may mention that Poland is a member of the FAIR consortium and of the ISOLDE collaboration, and has strong and formalized scientific collaborations with GANIL-ALTO in France and with LNL-LNS in Italy.

Poland also has acknowledged participation in integrating activities of the European nuclear physics communities, e.g., ENSAR2 and STRONG 2020. In particular, for some years now two Polish accelerator laboratories, HIL in Warsaw and CCB/IFJ PAN in Krakow,

have been among recognized trans-national access facilities in the ENSAR2 project.

The involvement of Polish scientists has high visibility in the numerous collaborations constructing and using nuclear physics spectrometers like SuperFRS at FAIR and S3 at SPIRAL2, gamma and charged particle arrays like AGATA, PARIS (Poland is the leading

country of this collaboration), CALIFA, and FAZIA and the neutron detector arrays NEDA and NeuLAND.

The major nuclear physics infrastructures in Poland, namely CCB/IFJ PAN in Krakow, HIL in Warsaw, the MARIA research reactor at NCBJ, Swierk and the eLBRUS accelerator at the University of Szczecin are playing an essential role both in Poland and in Europe through the development of high-level scientific research activities and their applications as well as in the training of the young generation of nuclear physicists, engineers and technicians. Their further development is essential for fundamental research and for applications related to energy production (future nuclear power plants) and medicine (radioisotope production and hadrontherapy).

Despite the ambitious projects for nuclear physics facilities in Europe there is an important lack of beam time dedicated to research. For example, only a few old generation heavy-ion accelerators are currently operating in central Europe (HIL, Rez and Debrecen cyclotrons). A new or highly upgraded specialized accelerator center in Poland would find a natural and important place in the international landscape of nuclear physics infrastructures. The Polish experimental and theoretical nuclear physics community has the full necessary scientific expertise and size to support and realize such a project.

References:

[1] <http://www.nupecc.org/lrp2016/Documents/lrp2017.pdf>

[2] <https://www.gsi.de/en/researchaccelerators/fair.htm>

3.2 The Heavy Ion Laboratory of the University of Warsaw

K. Rusek

Heavy Ion Laboratory, University of Warsaw, Warsaw, Poland

Introduction

The history of the nuclear physics facility at the University of Warsaw dates back to 1937 when Professor Andrzej Sołtan built the very first charged particle accelerator in Poland. This was a Cockcroft-Walton type accelerator delivering a beam of deuterons with an energy of 0.4 MeV and intensity up to 200 μ A. The Heavy Ion Laboratory (HIL) of the University of Warsaw (www.slj.uw.edu.pl), formally established in 1979, continues this long tradition. At present HIL runs two cyclotrons – a heavy ion U-200P of K=160 equipped with two ECR ion sources, accelerating beams in the range from He - Ar up to an energy of 10 MeV/A, and a PETrace K=16.5, delivering high intensity proton and deuteron beams. Since 1994, when the first heavy ion beam was extracted, HIL has been an effective “user facility”, serving scientists from Poland and abroad and becoming a recognised element of the European Research Area. Beam time is allocated by the Director based on the recommendations of the international Program Advisory Committee. The only criteria are the scientific merit of the project and its technical feasibility.

Since 2010 HIL, together with the Institute of Nuclear Physics of the Polish Academy of Sciences, has formed a consortium called the National Laboratory of Cyclotrons (NLC). From the 1st of March 2016 the consortium has formed one of ten European laboratories with Transnational Access granted by the European Union via the ENSAR2 project.

Scientific activities

The research program is mostly focused on low energy nuclear physics and its medical applications, including the production of radioisotopes.

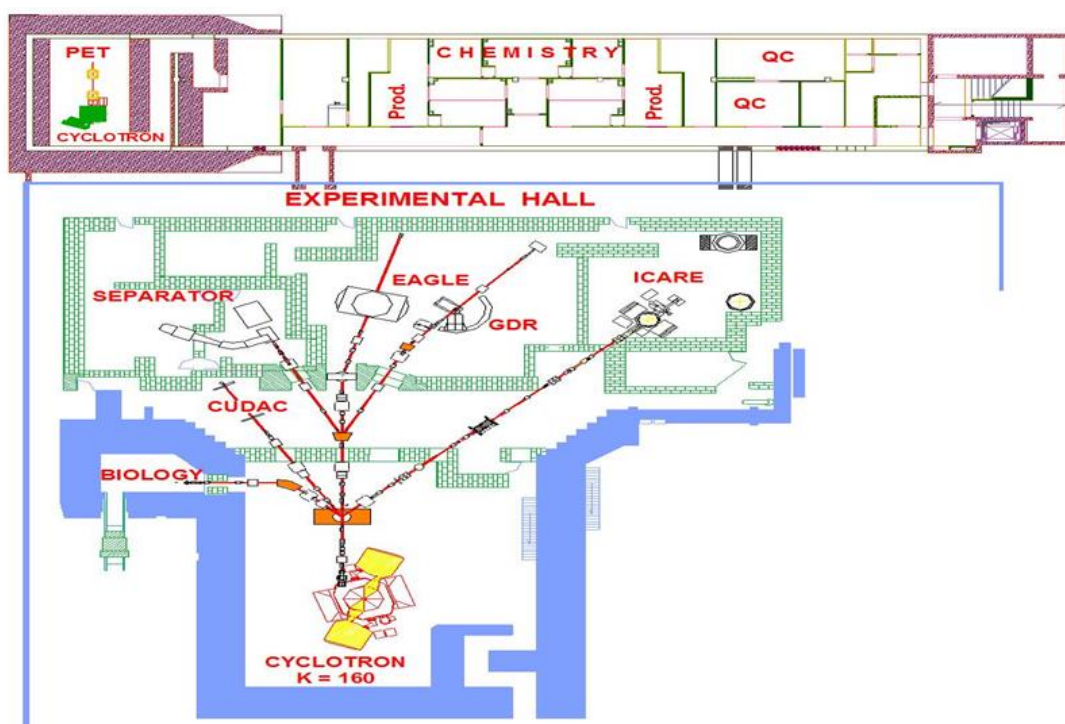

Fig.1 Layout of the HIL facility.

Experimental teams may take advantage of permanent set-ups installed on the beam lines or use their own dedicated equipment. Available apparatus includes: the EAGLE array – a γ -ray spectrometer, which can be easily coupled to ancillary detectors like an internal conversion electron spectrometer, a charged particle 4π multiplicity filter (Si-ball), a scattering chamber equipped with up to 110 PIN-diode detectors, a 60-element BaF_2 gamma-ray multiplicity filter, a precise plunger for pico-second lifetime measurements, ICARE - a charged particle detector system used for reaction studies, CUDAC – a PIN-diode array particle detection system, SEPARATOR – a Scandinavian type on-line magnetic separator, GDR – a multi-detector system consisting of a large NaI(Tl) crystal with passive and active shields and a 32-element multiplicity filter.

Studies of the electromagnetic properties of nuclei by means of Coulomb Excitation open the list of scientific projects that are performed at HIL. The team of physicists from HIL are among the world experts in this field, and are also invited to many experiments abroad. The team has developed and maintains the standard software used to analyze the experimental data (the GOSIA code) and organizes every couple of years an international GOSIA workshop. Other nuclear structure studies carried out at HIL are related to studies of K-isomers and life-times of various nuclear levels. In nuclear reactions, studies of the Coulomb barrier distributions for various pairs of interacting nuclei are performed as well as direct nuclear reaction studies bringing information about Spectroscopic Factors and Asymptotic Normalization Constants for light nuclei. An important part of the scientific program is concerned with the irradiation of living cells with the aim of investigating the Relative Biological Effectiveness of heavy ion beams.

Since 2012 the Radiopharmaceuticals Production and Research Centre (upper part of Fig.1), a division of HIL, has focused on the production of and research into radiopharmaceuticals for Positron Emission Tomography. The production of longer-lived radioisotopes for life-sciences applications is also carried on. In this field HIL closely collaborates with the Institute of Nuclear Chemistry and Technology (www.ichtj.waw.pl) and with the National Centre for Nuclear Research (www.ncbj.gov.pl).

Teaching

Being a university unit HIL is involved in teaching in a natural way. On average about 15 students/year (Bachelors, Masters, PhD, ERASMUS) from Poland and abroad work at HIL supervised by staff members. Every year HIL organizes a one-week workshop on “Acceleration and applications of heavy ions” for about 20 students from different Polish universities. Fig.2 presents the participants from the 13th Workshop held in October 2018.



Fig.2 Participants of the 13th Workshop on the Acceleration and Applications of Heavy Ions, October 2018.

It is addressed to students interested in nuclear physics and its applications and offers them a unique opportunity to gain experience in experimental methods of nuclear physics, control of the cyclotron, charged particle and gamma-ray detection techniques as well as medical applications of nuclear physics. Later on some of the students choose nuclear physics as the main subject of further studies at their home universities.

Popularization of science

For several years HIL has presented an award (the HIL Prize) to young scientists for outstanding results obtained at the HIL facility. The founder of the prize is Professor Takashi Tom Inamura who worked as a visiting professor at HIL during the years 1998-2002. Among the laureates are presently well-known scientists working in various European laboratories. Figure 3 shows the Professor T. Inamura and four of the laureates. Another important award presented by HIL is the Tomek Czosnyka Prize, awarded every second year to a young scientist for achievements obtained using the Coulomb Excitation method. This Prize is traditionally presented at the end of the Mazurian Lakes Conference on Physics. The Mazurian Lakes Conference is one of the most important among

the nuclear physics conferences organized in Poland. HIL co-organizes it with the Faculty of Physics of the University of Warsaw and the National Centre for Nuclear Research.



Fig.3 Professor Takashi Tom Inamura and some of the laureates of the HIL Prize (September 2017).

Perspectives

The staff of HIL is constantly working on the development of the facility. Among the current projects the largest is related to the coupling of the two cyclotrons in order to be able to accelerate (by the U-200P) light radioactive ions produced by the PETrace cyclotron and deliver them to the Experimental Hall.

A future project (in the perspective of a few years) is related to the replacement of the U-200P cyclotron with a new device that would incorporate improved energy, ion range and beam intensity parameters. This project, named HIL@ECOS, will allow for a unique device to be present in Poland and in our part of Europe. It will be used to carry out fundamental research in the field of nuclear physics, including research into properties of superheavy elements as well as a variety of applications in nuclear power, medical science, research into the properties of solid targets, astrophysics and others. A vital part of this project is the possibility to ensure the highest level of training for students and scientists by means of access to one of the top devices of this kind in the world. This project constitutes part of the implementation of the high intensity stable beams (ECOS) program, considered by the European Program FP7 EURONS and recommended by the Nuclear Physics European Collaboration Committee (NuPECC). The project has been submitted to the Ministry of Science and Higher Education for inclusion in the Polish Road Map of Research Infrastructures.

Summary

The Heavy Ion Laboratory of the University of Warsaw is the largest Polish nuclear physics facility and the only one equipped with a heavy ion cyclotron. It has served as a national nuclear physics laboratory for 25 years and has become a recognized element

of the European Research Community. About twenty projects a year are carried out using the HIL facility with the participation of about eighty scientists from various countries. An important part of its activity is teaching young adepts of nuclear physics. Some of them go on to join the society of Polish nuclear physicists. HIL has a well-defined program of development, with the most important element being the replacement of the U-200P heavy ion cyclotron by a modern accelerator.

3.3 Cyclotron Centre Bronowice

P. Olko, A. Maj

The H. Niewodniczański Institute of Nuclear Physics PAN, Kraków, Poland

Facility

The Cyclotron Centre Bronowice (in *Polish* – Centrum Cyklotronowe Bronowice, CCB) is part of the H. Niewodniczański Institute of Nuclear Physics of the Polish Academy of Sciences (IFJ PAN). The CCB is presently a major Polish accelerator facility - a modern nuclear physics research laboratory and the first proton radiotherapy centre in Poland. The activities of the CCB are focused around two cyclotrons which now operate at IFJ PAN – the “old” in-house developed AIC-144 isochronous cyclotron (accelerating protons to an energy of 60 MeV), and the “new” Proteus C-235 cyclotron with a proton beam of variable energy (between 70 and 230 MeV), installed in 2013.

The building of the Cyclotron Centre Bronowice (see Fig.4) houses the technical part and the medical area. The technical part contains the cyclotron vault and an experimental hall, together with laboratories for the preparation of experiments in physics and biology. The medical area provides the space necessary for the radiation therapy facility, including two scanning gantry therapy units, and for the required diagnostics and preparation of radiotherapy patients. The centre is fully operated by IFJ PAN staff who also maintain the cyclotron and the therapy systems.

The Proteus C-235 cyclotron (see Fig.5) was designed and produced by IBA (Ion Beam Applications S.A., Belgium) specifically for medical applications. It is an isochronous cyclotron with a compact conventional magnet, able to accelerate protons to an energy of 230 MeV. Protons of this energy have a range of some 32 cm in water, which enables their radiotherapy applications at all sites in the patient. An energy degrader and selector, allowing the beam energy to be downgraded continuously to 70 MeV, is an integral part of this installation. The basic parameters of the Proteus C-235 cyclotron are: weight – 220 tons, outer magnet yoke diameter – 4.34 m, magnetic field – up to 3.1 T, maximum current in the main coil magnet – 800 A, operating frequency – 106 MHz, radially-dependent dee voltage amplitude 50-100 kV, PIG-type internal source, extraction efficiency – 70%, maximum external beam current at 230 MeV – 500 nA, total operating power consumption, including magnet cooling and building air-conditioning – 1.3 MW.



Fig.4 A view of the CCB building, December 2016 (copyright: M. Ptaszkiewicz)



Fig.5 The Proteus C-235 isochronous cyclotron at the Cyclotron Centre Bronowice, IFJ PAN. (copyright: K. Gugula)

The variable energy beams of the Proteus C-235 cyclotron are directed to the physics experimental hall, to the C-235 eye treatment room and to two gantries (see Fig.6).

The Experimental Hall, of floor area 100 m² and a height of 5 meters, houses a single horizontal proton beam line of variable energy, mainly for basic research in nuclear physics.

Two preparatory rooms for physical experiments and two rooms for biological experiments are available in close vicinity to this experimental hall.

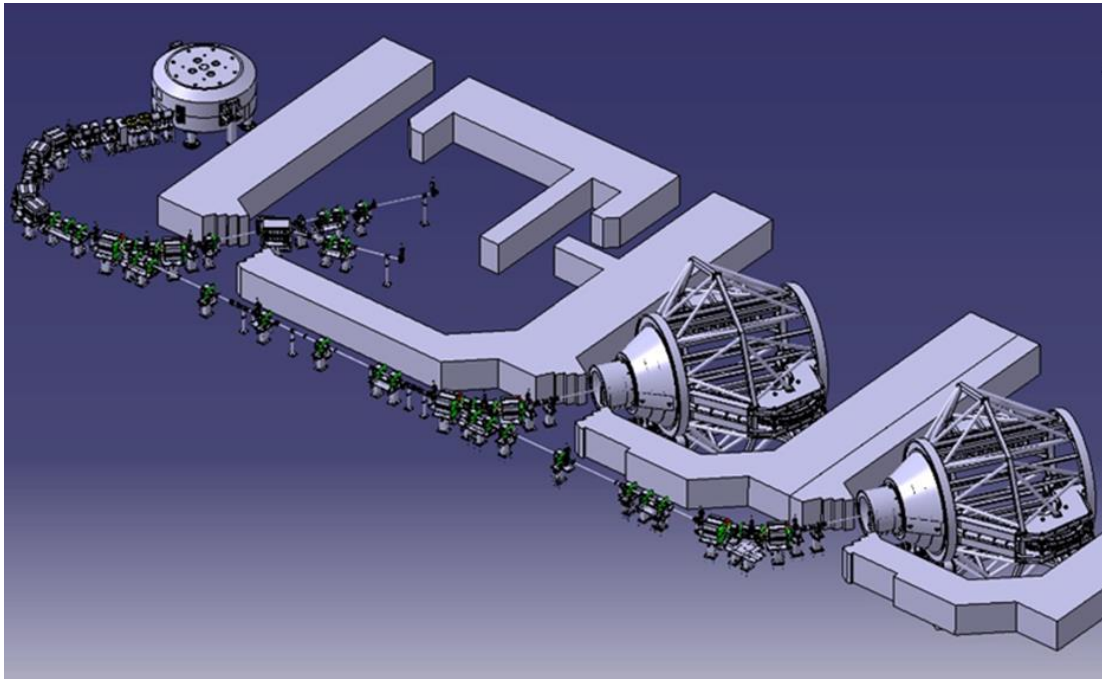

Fig.6 Schematic outline of the beamlines at the Cyclotron Centre Bronowice. The proton beam from the C-235 cyclotron is formed at the energy selector and transported to the experimental hall, eye treatment room and two scanning gantries.

Proton therapy

The proton treatment units and auxiliary medical rooms are located in the western, medical part of the new CCB building. The medical part consists of three treatment rooms, one with a horizontal 70 MeV proton beam line for eye treatment, and two rooms equipped with rotating gantries, which allow the patient to be irradiated from any direction (0° - 360°).

The eye treatment room was designed, fully equipped and commissioned by the physicists, engineers and technicians of our Institute. The 230 MeV proton beam is degraded to an energy of 70 MeV and delivered to a specially designed eye therapy room where it is suitably formed and monitored. The eye therapy facility is equipped with several in-house developed beam forming elements. The beam line allows a small tumor volume in the patient's eyeball to be irradiated at dose rates ranging between 6 – 32 Gy/min. The proton beam range in water (90% at the distal edge) is 31.5 mm, the distal fall-off (90%–10%) is less than 1.8 mm and lateral penumbræ measured in air (90%–10%) do not exceed 2 mm. These parameters are in line with other ocular radiotherapy centers worldwide.

Both gantries are equipped with dedicated IBA nozzles which are able to apply fields of up to 30 cm x 40 cm using proton Pencil Scanning Beams. The patient is positioned with the aid of a robotic positioner, orthogonal X-ray imaging sets and a Vision-RT optical verification system. For treatment of paediatric patients, anaesthetic columns and units are installed with access to anaesthetising gases. Imaging for treatment planning is conducted using a Siemens Somatom AS Open wide-bore computer tomography (CT) scanner which

enables fast scanning using a dual-energy protocol. The CT room also contains lasers for virtual simulation and an optical patient positioning verification system for alignment and gating purposes. In the CT room there is also full access to anaesthesiology procedures. A dedicated room has been prepared for paediatric patients, with a mobile anaesthesiology unit, allowing out-of-room patient preparation. After treatment paediatric patients are transferred to a wake-up room equipped with monitored intensive-care beds. Patient-specific immobilization devices, such as thermoplastic masks, cushions or vacuum bags, are prepared in a dedicated modelling room equipped with a movable patient couch, alignment lasers, a water bath, vacuum pumps and other accessories. The patient treatment facility has been fully operational since October 2015. Up to 500-700 patients a year can be treated here, depending on their treatment site and treatment schemes.

Nuclear physics experiments

In addition to medical applications, the Proteus-235 cyclotron at CCB is also an excellent device for conducting basic research in the field of nuclear physics. This takes advantage of the proton beam with energies from 70 to 230 MeV, which constitutes a “niche” in the European infrastructures. Since CCB Krakow is mainly a medical facility where proton therapy of tumors with the two gantries is conducted, nuclear physics experiments are carried out during the time when patients are not being treated, i.e., mainly at night and during the weekend.

The most important elements of the scientific equipment available at CCB are arrays of high-energy gamma detectors (HECTOR, PARIS, 4 large volume LaBr₃ detectors), high-energy proton detectors (KRATTA), and the BINA detector system used to detect the emission angle and energy of light charged particles.

The scientific research program, as advised by the International Advisory Committee, encompasses mainly two areas of experimental nuclear physics: gamma spectroscopy of exotic excitations of the atomic nucleus and few-body interactions in the atomic nucleus. The first area of research includes measurements of gamma quanta emitted, for example, during the decay of Giant or "Pygmy" nuclear resonances. Nuclear giant resonances are well-known basic excitations of atomic nuclei with energies of 10-20 MeV, i.e. much higher than the neutron separation energy, consisting of synchronous oscillation of all protons against neutrons. These excitations carry important information about the nuclear structure. The recently discovered Pygmy resonances, in turn, are other collective states of the atomic nucleus, with energies in the vicinity of the neutron binding energy (7-10 MeV). These excitations are most often interpreted as neutron skin oscillations against the remaining core of the nucleus, but the full experimental confirmation of this hypothesis is still missing because of the small number of precise experimental data.

The idea of the study of gamma-ray decay from states excited by fast protons relies on the measurement of scattered protons in coincidence with gamma rays. The inelastic proton scattering reaction takes place in the vacuum chamber (see Fig.7) large enough to accommodate inside the detectors for light charged particles. The presently assembled experimental setup comprises the KRATTA detectors, coupled to 4 large volume LaBr₃ crystals, two PARIS clusters and a DSSSD silicon detector (see Fig.8).

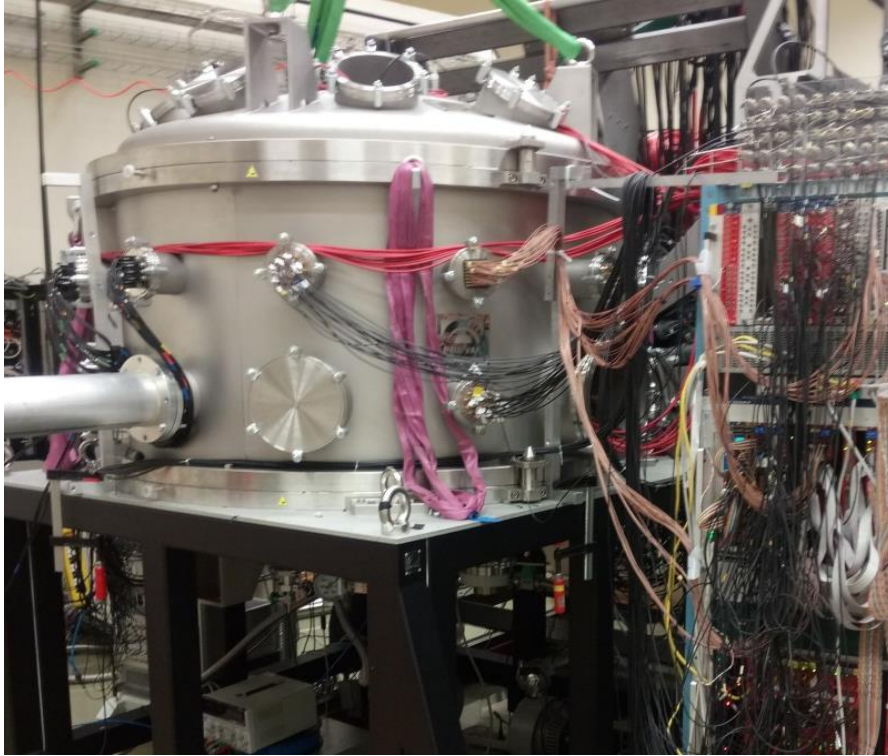

Fig.7 Photo of the large vacuum reaction chamber.

The KRATTA array consists of 24 triple telescopes (Si, CsI, CsI) placed inside the chamber at a distance of 40 cm from the target, covering polar angles between 4 and 45 degrees on both sides of the beam axis (in case of being used together with the PARIS clusters). It can measure energies of scattered protons from 2.5 to 260 MeV. Four plastic scintillators are mounted in the front of each KRATTA module enabling scattered protons to be measured with an angular resolution of 2 degrees.

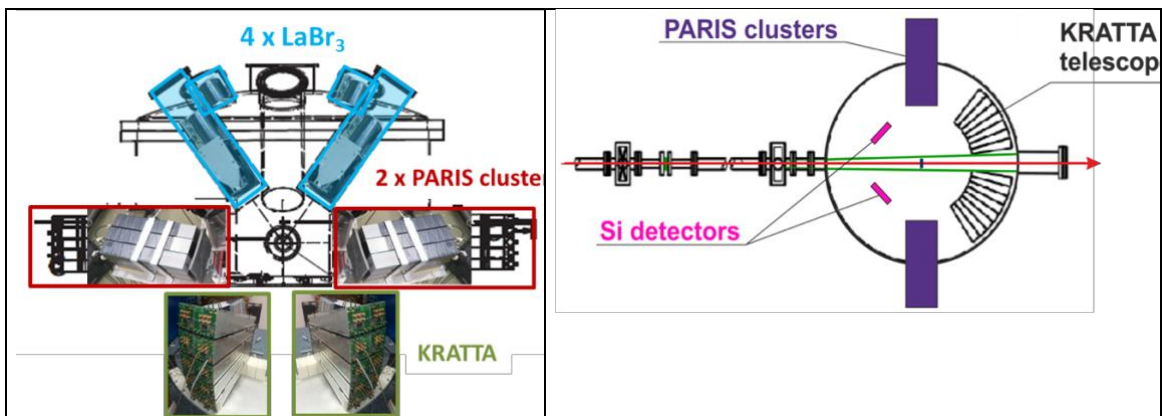

Fig.8 Schematic layout of the setup: left – view from the front; right – view from the top.

The scintillation detectors for gamma-ray measurements are mounted outside the scattering chamber using special holders, i.e., cylindrical pockets installed on the chamber walls. They allow four large volume LaBr₃ detectors to be placed at the top of the chamber and two PARIS clusters on both sides at 90 degrees, at a distance of 25 cm from the target. Each PARIS cluster is assembled from 9 phoswich detectors. One consists of LaBr₃+NaI scintillators; the second – of CeBr₃+NaI.

For the study of high-lying single-particle states, in addition to the setup described above a Double-Sided Silicon Strip Detector will be used to measure light charged particles emitted during the decay of the excited states. It is mounted inside the vacuum chamber at 110 degrees at a distance of 20 cm from the target.

The second research project pursued at CCB concerns the experimental study of few-body interactions in the atomic nucleus. In the theory of the atomic nucleus it was often assumed for simplicity that the many body system which is the atomic nucleus can be accurately described by considering only interactions between pairs of nucleons. It is known, however, that in systems of complex objects, such as nucleons, three-body or higher-order forces appear. In recent times it has indeed been shown that in ab-initio calculations three-body forces are necessary to describe the properties of light atomic nuclei, and their use in the description of heavy nuclei can significantly improve the quality of predictions such as binding energy. In this context, the experimental determination of the parameters determining three-body interactions is of decisive importance. Three-body forces can be examined by colliding, for example, a proton with a system of two nucleons such as a hydrogen nucleus with one neutron, i.e., a deuteron. Such tests are being and will be carried out using the proton beam from the cyclotron at CCB. The detection system is the BINA detector, used to record the direction of flight and the energy of the two protons which are emitted after the collision of a proton with a deuterium nucleus. The range of proton energies available from the Proteus-235 cyclotron and the possibility of rapid changes of this energy make the CCB laboratory an ideal and unique in Europe place for research in the field of nuclear few-body systems.

Fig.9 shows a schematic view of the BINA (Big Instrument for Nuclear physics Analysis) detector, that was designed for studies of few nucleon system dynamics in deuteron-proton and deuteron-deuteron reactions. Initially at KVI Groningen, in 2012 it was installed at CCB. With almost full solid angle coverage it allows the identification of charged particles and the precise reconstruction of their trajectories. Particles emitted at forward angles (in the range 10° - 40°) are registered in a Multi-Wire Proportional Chamber (MWPC) and then pass to a system of two scintillator hodoscopes where their stopping power and total energy are measured. The MWPC is positioned about 300 mm downstream from the target and consists of three wire planes, one with horizontal, one with vertical and one with wires inclined at 45° , for unambiguous reconstruction of the positions of up to two particles with resolution below 4 mm. Directly behind the wire chamber the scintillator hodoscope is situated, built of 24 strips, each 2 mm thick and 35 mm wide, arranged vertically to form a square-like active area of about $400 \times 400 \text{ mm}^2$. This provides energy loss information. The total energy of detected particles is measured by a second hodoscope consisting of 10 horizontally arranged 120 mm thick and almost 2 m long scintillator slabs. In order to minimize the number of particles crossing the borders between neighboring elements the slabs are arranged to form a cylinder, with the center at the target position and a radius of 755 mm. Both-side readout of each slab is used to minimize position dependence of the detector response as well as for rough reconstruction of the hit position along the scintillator. Particles emitted at polar angles larger than 42° are registered in the so-called BALL part of the detector. This consists of 149 scintillator phoswich elements arranged in a football-like structure. All elements are glued together to form a vacuum scattering chamber equipped with a thin exit window made of 50 μm thin aramid foil reinforced with Kevlar fibers. All the scintillation detectors of the BINA system can be used for triggering purposes. In the center of the scattering chamber a cryogenic liquid target assembly is situated. A remotely controlled target setup allows a choice between

three different scattering targets, of which one is either liquid deuterium or hydrogen (from 2 to 10 mm thick). The remaining positions are usually used for mounting a ZnS screen for on-line beam spot observation, solid targets (CH_2 and/or CD_2) or various auxiliaries for halo or background studies.

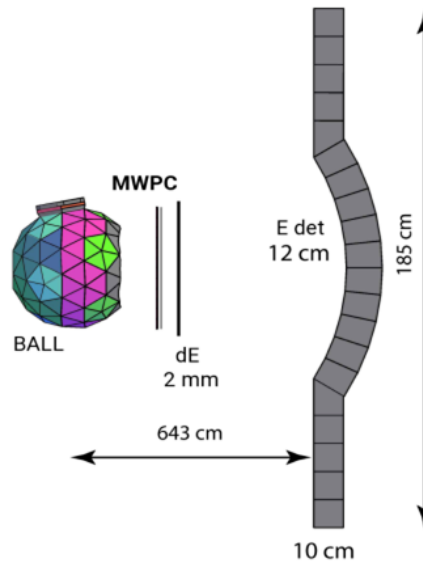

Fig.9 Schematic side view of the BINA detector.

In addition to the two main nuclear physics activities described above, other topics are studied: structure of single-particle states close to the particle evaporation threshold, investigation of the mechanism of proton-induced fission and spallation, modelling hadron therapy by gamma-rays, and, last but not least, in-beam testing of novel detectors constructed for large infrastructures, e.g. CALIFA, PARIS or FAZIA.

Concerning the future upgrading of the experimental part of CCB, new detector systems, such as, for example, an array of small LaBr_3 scintillators, a germanium array and a tape station for studies of isomeric decay of exotic nuclei from fission or spallation processes are being considered. In the more distant future, an additional, larger experimental hall is under discussion.

3.4 Nuclear Physics at Extremely Low Energies: A Small Accelerator System under Ultra High Vacuum Conditions

K. Czerski

Institute of Physics, University of Szczecin, Szczecin, Poland

A new accelerator system is a central part of the eLBRUS (Laboratoria Badawczo-Rozwojowe Uniwersytetu Szczecińskiego) laboratories situated at the University of Szczecin. Other laboratories of eLBRUS such as the Laboratory for Radiospectroscopy and the Laboratory for Optoelectronics are also equipped with modern facilities, for instance a superconducting nuclear spin spectrometer or high intensity lasers, and can be used for some diagnostic purposes of nuclear experiments at very low energies which are mainly devoted to astrophysical problems of the creation of the chemical elements in the universe or to applied research relevant to developing new nuclear energy sources based

both on nuclear fusion and fission. Likewise, some radiobiological studies can be performed.

However, the main aim of the new accelerator system is to study nuclear reactions at the lowest possible energies for which atomic degrees of freedom are important and the target surface should be atomically clean. These two conditions define all the important parameters that determine the uniqueness of the entire system. Since the investigated reactions take place far below the Coulomb barrier and the corresponding cross sections decrease very fast with the diminishing projectile energies, we need a high current ion source with very good energy definition. Target cleanliness is important because any target surface impurities lead to a reduction in the energy of the projectiles and disturb the atomic processes we would like to study. Thus, ultra-high vacuum (UHV) conditions at the target chamber as well as surface physics diagnostics of the targets used are necessary.

The system, finally equipped at the end of 2015, consists of two independent parts manufactured by different companies: the accelerator and beam transport system (Dreebit GmbH, Germany) and the UHV target chamber with diagnostic equipment (PREVAC, Poland), see Fig.10. The 2.7 GHz ECR ion source with permanent magnets can provide light and heavy ion beams (up to Ar) of high currents (up to several mA deuteron beam on target) with a long-term energy resolution of a few eV. A 90° double focusing analyzing magnet and system of magnetic and electrostatic focusing elements delivers the ion beam through the units of the differential pumping system to the target chamber. The target chamber (Fig.10 right) is built of mu-metal to shield the magnetic field and to enable electron spectroscopy of the target surface. It works under UHV conditions with a pressure down to 10^{-11} mbar and is equipped with an electron gun operating together with a high-resolution electrostatic electron detector. Thus, Auger electron spectroscopy (AES) can be utilized for investigation of the cleanliness and structural contamination of the target surface.



Fig.10 The UHV accelerator system at the University of Szczecin. Left: ECR ion source and analyzing magnet. Right: Target chamber

Targets are placed in the center of the chamber on a 5-axes manipulator combined with a laser positioning system. The targets, mounted on a transportable target holder, can be cooled down to -170°C and heated to 1200°C and are moved by a linear transfer system from a load lock chamber to avoid unnecessary ventilation of the whole target chamber. Two different detection systems of charged nuclear reaction ejectiles can be used. A close

geometry system is based on an Si detector telescope setup that enables the largest possible detection solid angle to be covered. The second detection system is designed for measurements of reaction angular distributions and consists of many large area Si detectors placed at larger distances from the target. A combination of both systems depending on experimental requirements is possible.

An example of experimental results obtained at the UHV accelerator system is presented in Fig.11 where the reaction enhancement factor, defined as the ratio of the experimentally determined cross section for the ${}^2\text{H}(d,p){}^3\text{H}$ reaction taking place in a metallic Zr environment, to the theoretical cross section describing gas target experiments is depicted.

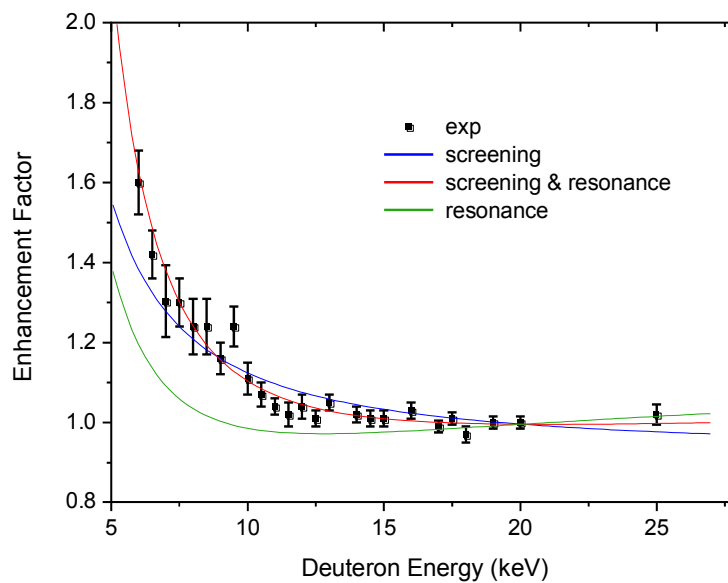

Fig.11 Enhancement factor for the ${}^2\text{H}(d,p){}^3\text{H}$ reaction, contributions due to the threshold resonance and electron screening effect [1].

The enhancement observed at deuteron energies below 10 keV probably results from two effects: the electron screening effect and the contribution of a new threshold resonance. The first one is due to shielding of the Coulomb barrier by quasi free metallic electrons, and the second one could be recognized for the first time because of a destructive interference between different cross section components leading to a flat energy dependence of the enhancement factor for energies above 10 keV. However, to distinguish unambiguously different contributions, a measurement at deuteron energies down to 1 keV, for which the cross section could be increased even by a factor of several thousand, is needed and important for both nuclear astrophysics and the fusion reactor technique.

The UHV accelerator system at the University of Szczecin should, therefore, be improved in the near future by an additional deceleration/acceleration unit placed in front of the target chamber. In the case of the 1 keV measurements, it will allow operation of the ECR ion source at higher voltage to get higher deuteron currents and simultaneously reduction of the deuteron energy before impinging on the target. On the other hand, the acceleration mode of the additional unit can increase the total energy of the ion beam to about 100 keV per charge unit, which will open a new field for our investigations – we plan to study crystal lattice damage induced by heavy ions in structural materials of future fission and fusion reactors. The interaction with matter of heavy ions is much more effective than that

of neutrons and thus can simulate neutron irradiation in reactors. In Fig.12, the influence of crystal lattice defects on the enhancement factor in the d+d reaction is demonstrated – changing the electronic band structure of the target can change the nuclear cross sections. For this kind of experiment the target chamber will be additionally equipped with X-ray and UV sources to apply XPS and UPS spectroscopic diagnostic methods. Furthermore, increasing the ion energies will enable the use of neutrons from the ${}^2\text{H}(d,n){}^3\text{He}$ reaction for radiobiological studies of the non-linear response of biological samples to ionizing radiation and to continue our research [2] performed till now in other laboratories.

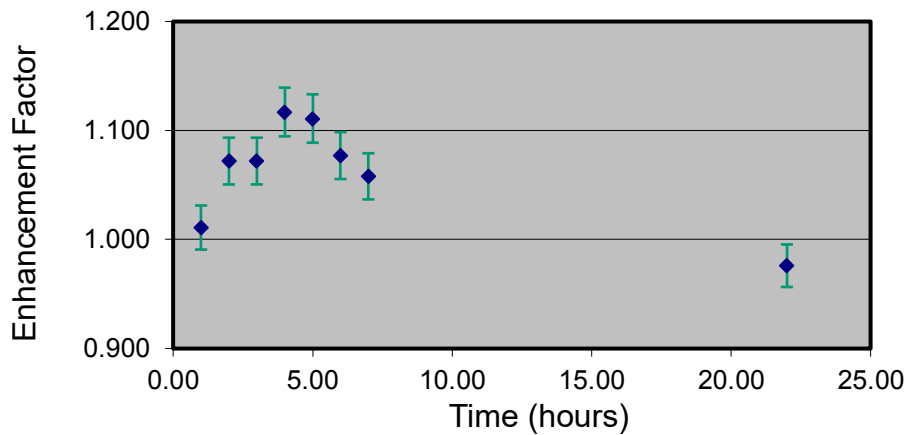

Fig.12 Dependence of the enhancement factor on the irradiation time at a deuteron energy of 14 keV. The increase during the first 5 hours results from the crystal lattice defects.

References:

- [1] K. Czerski, D. Weißbach, A.i.Kilic, G. Ruprecht, A. Huke, M. Kaczmarek, N. Targosz-Slecza, K. Maass, Europhysics Letters, 2016
- [2] A. Kowalska, E. Nasonova, K. Czerski, P. Kutsalo, W. Pereira, E. Krasavin, Radiation and Environmental Biophysics, 2019

3.5 The MARIA research reactor with the Interdisciplinary Laboratory of Materials and Biomedical Research

(current status and perspective for 2050)

M. Gryziński, M. Maciak, R. Prokopowicz
National Centre for Nuclear Research, Świerk, Poland

The MARIA nuclear research reactor is (after the shut-down of the former EWA reactor on February 24, 1995) the only nuclear reactor operating in Poland. Its nominal thermal power is 30 MW. It is an experimental and production reactor currently designed for the following purposes:

- irradiation of materials for the production of radioisotopes,
- materials engineering and technological research,
- development and testing of nuclear measuring and diagnostic systems and subassemblies,
- neutron doping of semiconductor materials,
- neutron modification of materials,

- physical and neutronographic examinations,
- use of neutron beams for medical purposes,
- training objectives in physics and reactor technology.

It has a favorable geographical location (isolation from human settlements - see Fig.13) and thanks to this has avoided the fate of many European nuclear research reactors that have been closed for security reasons.

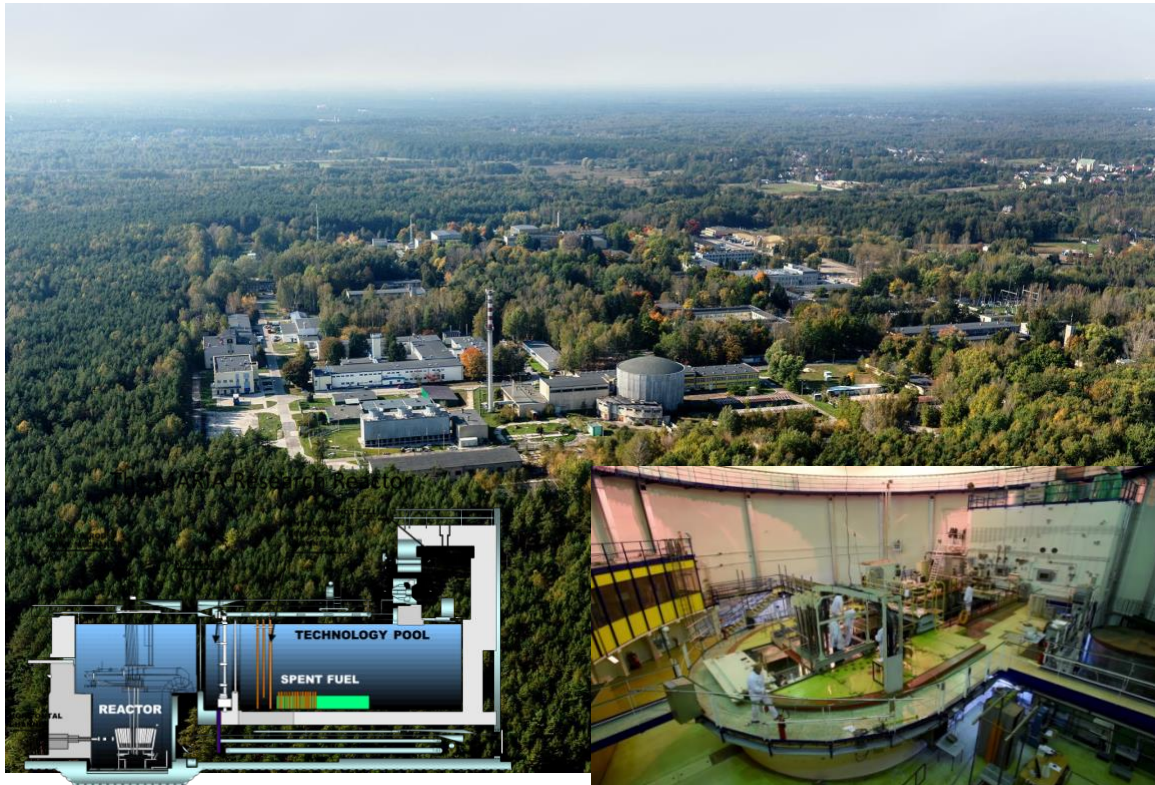

Fig.13 Technological overview of the MARIA reactor

The MARIA reactor is a multi-purpose high flux research reactor. It is a water and beryllium moderated reactor of the pool type with a graphite reflector and pressurised channels containing concentric tube assemblies of fuel elements (see Fig.14). It was designed to provide a high degree of flexibility. The fuel channels are situated in a matrix of beryllium blocks and enclosed by a lateral reflector made of graphite blocks in aluminium cladding. The MARIA reactor is equipped with vertical channels for irradiation of target materials, a rabbit system for short irradiations and eight horizontal neutron beam channels (one under conceptual work for construction of an in-core rabbit system for large samples, one new thermal to fast neutron, large diameter, large density for biological and medical purposes in commissioning by the regulatory body and six under renovation for fundamental physics research and neutronography).

The MARIA reactor is one of the largest research reactors in Europe. The neutron irradiation services provided at the MARIA research reactor include a wide range of radioisotope production, neutron activation analyses and biomedical technology.

The thermal neutron flux density (assuming a Maxwell distribution around a velocity of 2.2 km/sec, being the equivalent of 25 meV) in the MARIA reactor reaches up to

$2 \cdot 10^{14} \text{ cm}^{-2}\text{s}^{-1}$, whereas the fast neutron (i.e. fission neutrons of mean energy 1-2 MeV) flux density achieves $1 \cdot 10^{14} \text{ cm}^{-2}\text{s}^{-1}$. The irradiation channels differ in neutron energy spectrum, neutron flux density and irradiation volume (diameter).

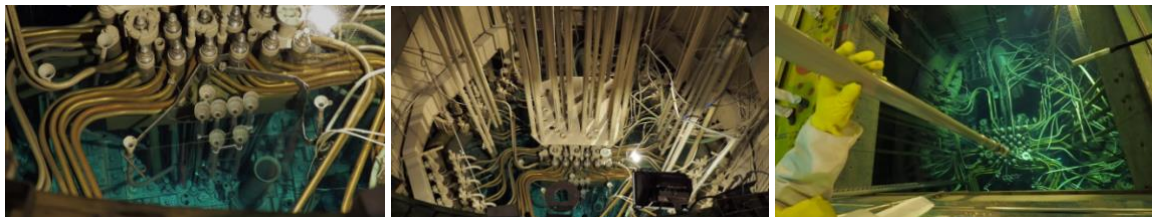
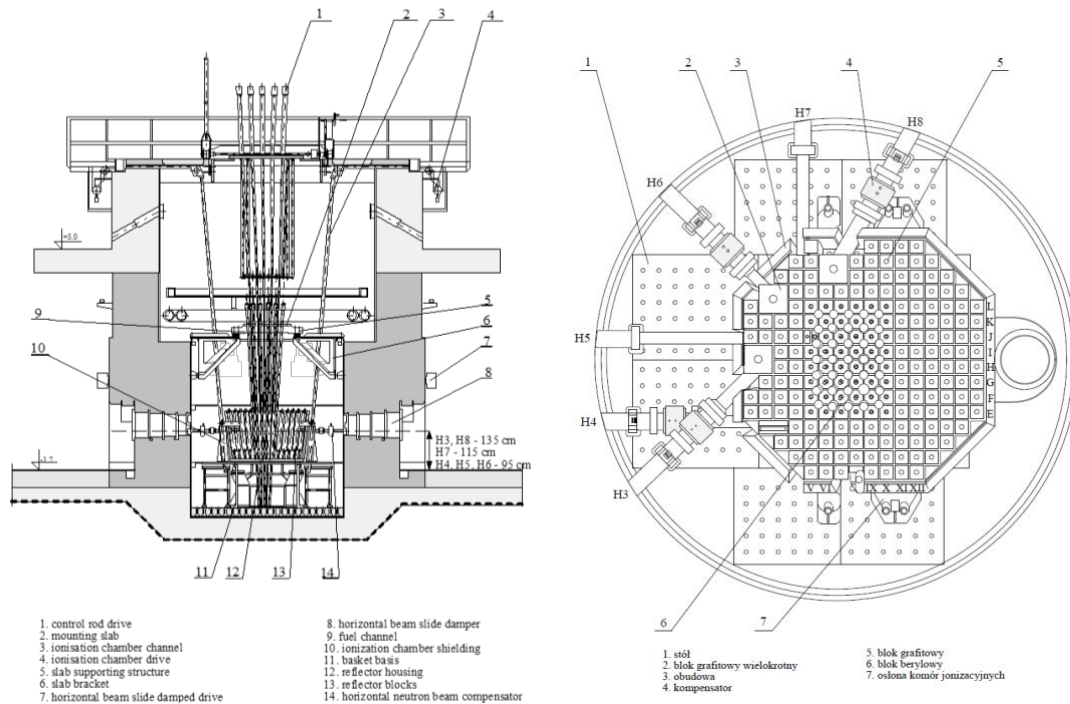

Fig.14 Reactor cross sections of the pool

Physical hall with 8 horizontal channels and in-core positions

Four of the irradiation channels are equipped with a hydraulic post (rabbit) system, which facilitates quick irradiation with 1 sec accuracy. The other channels are devoted to fast neutron irradiation. They are well shielded from the thermal neutrons. The fast neutron flux there is equal to from $1 \cdot 10^{11}$ to $3 \cdot 10^{12} \text{ cm}^{-2}\text{s}^{-1}$, whereas the thermal neutron flux is reduced to $3 \cdot 10^{10} \text{ cm}^{-2}\text{s}^{-1}$. These channels are over 80 mm in diameter and 900 mm in height. The irradiated samples are low activated, and mostly neutron induced degradation occurs. Therefore, these channels can be used to irradiate large samples, e.g. apparatus, etc. The MARIA reactor is also equipped with a 14 MeV neutron irradiation facility. The purpose-built channel is based on two stage nuclear reactions driven by thermal neutrons. It achieves up to $1 \cdot 10^9 \text{ cm}^{-2}\text{s}^{-1}$ 14 MeV neutrons.

The highest neutron flux levels are achieved in the middle of the core or inside the fuel elements. They are used mostly to manufacture radionuclides for medicinal purposes, e.g. brachytherapy, diagnosis, etc. In addition, the various kinds of neutron energy spectra can be used to test nuclear reaction cross sections. Verification of neutron reaction cross sections occurring in some astrophysical processes can be performed. Especially s-process

reactions can be investigated. Currently, an international project devoted to research into the $^{186}\text{Re}(n,\gamma)^{186}\text{Re}/^{186\text{m}}\text{Re}$ cross section and its impact on the ^{187}Re - ^{187}Os cosmochronometer is being conducted. As well as using existing vertical channels for neutron irradiation, there is also the possibility to install an in-core loop for investigation of minute half-life nuclides, like the one proposed in [DOI: 10.1051/epjconf/201714601003].

The reactor is also equipped with seven horizontal beam channels (see Fig. 15). Six of them provide thermal neutron beams. Of these, five are to be equipped with various kinds of neutron spectrometers and diffractometers. Many of the instruments will be provided by the Helmholtz-Zentrum, Berlin. They will be used to investigate solid state atomic and magnetic structures. The neutron beam can be used to investigate the “quantum nature” of the neutron by detection of fluctuations of the neutron probability density function. One of the thermal neutron beams is used to perform neutronography imaging. The other horizontal channels, currently under construction, will provide fast neutron beams. The neutrons are to be slowed down to epithermal or thermal energies. The beam is therefore devoted to providing a wide range of neutron energy spectra, depending on the neutron filters applied. Among other purposes the channel is to be used for radiobiological and biomedical research, e.g. connected with neutron capture therapy. The horizontal beams are also used for interdisciplinary research, e.g. investigation of antique paintings (autoradiography), testing of shielding materials, testing of electronic components, etc.

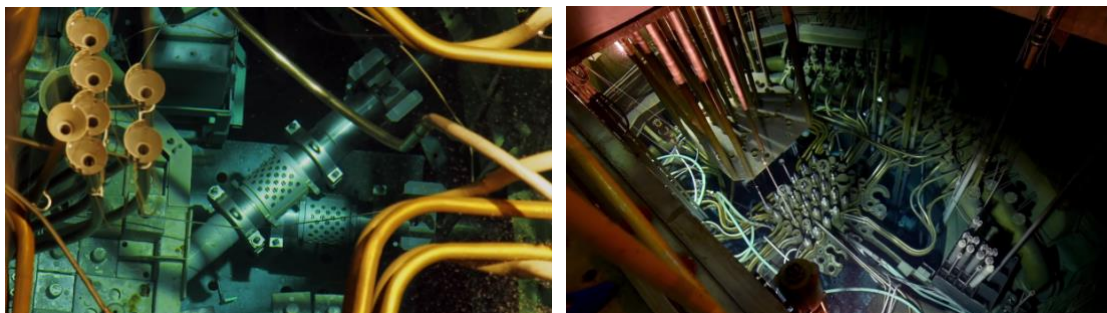

Fig.15 Horizontal tubes for neutrons and in-core position for irradiation

Due to the possibility of achieving a specific neutron energy spectrum (e.g. $kT \approx 30$ keV) the currently constructed horizontal epithermal neutron beam can be particularly useful for research into s-process reactions. In addition to the above-mentioned applications, installation of a thermal neutron driven heavy-ion source (yield ca. $106 \text{ s}^{-1}/2\pi$) on the horizontal beam is currently being considered. This facility could be used to test electronic components. Installation of a neutron induced positron source (guided outside the facility) is also under consideration.

The nuclear reactor is not only a strong neutron source but also a strong neutrino source. The electron antineutrinos come mostly from beta decay of unstable neutron-rich fission products. During full power operation the MARIA reactor is an electron antineutrino source of yield $\sim 5 \cdot 10^{18} \text{ s}^{-1}$. This means that the reactor neutrinos exceed the solar ones up to a distance of ca. 25 m from the reactor core. If we note that the minimum distance that can be approached to the reactor core is ca. 5 m, then one may remark that it is possible to investigate neutrino oscillations at the MARIA reactor [arXiv:1702.00941v2; arXiv:1811.05694v1; Nucl. Instr. Meth. A845 2017 467].

Possible new research infrastructures at the MARIA reactor are also being considered. The most promising seems to be a cold neutron ($E_n < 20$ meV) source. Very cold ($E_n < 0.05$ meV) and ultra-cold ($E_n < 300$ neV) neutrons are particularly interesting from the state-of-the-art scientific point of view. Their extremely high reaction cross sections facilitate many applications. At the same time their large wavelength makes them easily reflected from a broad range of materials. Cold neutrons can therefore be guided for long distances outside the reactor facility by curved guides. Thus, they may be separated from the gamma radiation. Ultracold neutrons are the only particles in which the influence of the gravitational field has been observed so far. Measurements of the quantization of neutron energy states in the potential of the Earth's gravitational field are a striking example of the powerful research capabilities of cold neutrons [Nucl Instr Meth A 440 (2000) 754; Phys Rev D 67 (2003) 102002; Nature 415.297.2002]. Recently, ultracold neutrons have played a significant role in other state-of-the-art research, like the quest for the neutron lifetime. Unlike other particles, determination of the neutron half-life value appears to be problematic. A significant, constant discrepancy appeared between the neutron lifetimes measured by two different methods: the in-flight (beam) method and UCN storage (magneto-gravitational trap - bottle) method [Phys Rev D 98, 030001 (2018)]. An accurate determination of the neutron half-life has a significant impact on primordial nucleosynthesis predictions [Phys Rev D 71(2005) 021302]. Recently the constant and significant discrepancy in the neutron lifetime led to an exciting neutron decay Dark Matter interpretation [Phys Rev Lett 120 (2018) 191801; Phys Rev C 97 (2018) 042501]. Ultracold neutrons are also used in low-range gravitational force investigations, including e.g. the idea of Dark Energy as a scalar field with a potential that depends on the local mass density [Phys Rev Lett 112 (2014) 151105; Phys Lett B 743 (2015) 310], in investigations of the neutron electric dipole moment (including CP symmetry violation) [Phys Rev D 92 (2015) 092003] and in investigations of neutron-antineutron oscillations [Phys Rep 612 (2016) 1], which is strictly connected with Baryogenesis, B-violation and beyond Standard Model hypotheses. As one can see, cold neutrons are a powerful research tool in the field of low-energy nuclear physics and more. Thus, building a cold neutron source at the MARIA reactor could significantly advance the development of nuclear physics in Poland.

Currently the main tasks of the reactor include:

- production of radioisotopes, used in nuclear medicine (including technetium-99 – in 2014 NCBJ provided 18% of world-wide deliveries), exported among others to the USA. Maria is one of only seven reactors in the world in which this type of isotope is produced,
- modification of materials by irradiation,
- development and testing of nuclear measuring and diagnostic systems and subassemblies,
- research on neutron beams,
- radiochemistry tests using fired fuel rods,
- research on neutron therapy.

Radionuclides produced in the MARIA reactor are primarily used for the needs of nuclear medicine. The radioisotope center POLATOM operating at NCBJ produces radiopharmaceuticals delivered to hospitals in eighty countries on six continents. In particular, the production of the MARIA reactor satisfies the main part of the global demand for iodine-131 used in treatment of the thyroid gland. Since March 2010, in cooperation with a foreign partner, the reactor has implemented the technology

of irradiation of uranium targets for the production of molybdenum. Irradiated shields prepared in the MARIA reactor are the basis for the production of molybdenum-technetium generators containing molybdenum-99. As a result of the molybdenum decay, technetium-99m is formed, which is the basic component in most oncological diagnostics procedures. Only one week of reactor operation means the possibility of testing one hundred thousand patients around the world. Recently, the reactor research team has become involved in the production of holmium-166 microspheres for medical diagnostics and treatment of the liver which seems to be a most promising procedure for MRI because of its paramagnetic properties, in addition to the therapeutic aspect of holmium being a beta emitter (^{166}Ho gives both therapeutic and treatment attitudes).

Completion of the investment will allow NCBJ scientists to conduct research in the fields of radiobiology, radiation dosimetry, irradiation of biological materials and training of oncologists and medical personnel. The most recent project of scientists working at the MARIA reactor is the Interdisciplinary Laboratory of Materials and Biomedical Research. In the laboratory research will be carried out in the field of new neutron technologies, developmental research on new dosimetry techniques taking into account the construction of detectors for measurements in mixed fields. In addition, the infrastructure under construction will ensure the conducting of radiobiological, radiochemical, and also spectrometric and neutron analyses of activation studies. The world of science informs the need to open a radiobiological laboratory. The Radiobiological Laboratory of Biomedical Research, which was opened last month, is the introduction to the creation of an Interdisciplinary Laboratory of Materials and Biomedical Research.

Chapter 4

Superheavy Elements

Convener
J. Skalski

National Centre for Nuclear Research, Świerk, Poland

A recent proposal for a new heavy-ion accelerator for HIL, possibly with more intense beams of ions heavier than presently available, brought the prospect of experimental studies of very heavy or superheavy (SH) nuclei in Warsaw. The following contributions address various scientific and technical/instrumentational aspects of such a project.

In terms of the scientific value, studies of SH nuclei have a high rank as they deal with the boundaries of the table of nuclides where potential discoveries may be expected. Nuclear structure in this region will be affected by the still uncertain shell structure beyond lead. Exotic nuclear shapes and collective modes may appear due to large particle numbers, strong electrostatic repulsion, and weaker pairing. The filling of unusually high- j subshells may lead, for specific Z and N , to high- K ground- or low-lying states (in odd and odd-odd nuclei) and to high- K isomers, some of which may have life-times comparable to, or longer than the ground states. The study of the competition between the various decay modes of different low-lying configurations could shed new light on the mechanism of alpha decay and fission. A separate area of research is the reaction mechanism responsible for the production of very heavy compound nuclei. From the point of view of chemistry, SH atoms also present great interest; one-atom-at-a-time chemistry is possible for SH species living longer than ~ 1 s.

Although the half-lives of the longest-lived isotopes of SH elements seem attractive from the experimental point of view, e.g., 7.6 s for ^{278}Mt , 9.6 s for ^{281}Ds , 26 s for ^{281}Rg , 29 s for ^{285}Cn or 19.6 s for ^{286}Nh , all these isotopes have only been observed as alpha-decay products and are unavailable as evaporation residues. Unfortunately, those produced as evaporation residues decay much faster. This impedes studies of their structure or the chemistry of the corresponding elements. Production cross sections steeply drop with increasing Z : from 38 nb for ^{257}Rf in the $^{50}\text{Ti}+^{208}\text{Pb}$ reaction or 10 nb for ^{263}Db in $^{18}\text{O}+^{249}\text{Bk}$ (actinide target) to a tiny 7.5 pb for ^{266}Mt in the $^{58}\text{Fe}+^{209}\text{Bi}$ reaction or 3 – 10 pb for $^{269-271}\text{Ds}$ in reactions with various Ni+Pb isotope combinations. The use of actinide targets and a ^{48}Ca beam provides easier access to $Z > 112$, but it requires various safety arrangements.

Dedicated tools are needed to proceed with such studies, as they differ in many respects from typical nuclear structure or reaction experiments. In particular, long running times are needed which means that other studies would be (at least partly) affected. A serious study of SH elements would require the formation of a team of scientists specializing in this field, and such a team should be supported for a period of at least 10 years.

One could realistically expect that the anticipated studies of SH nuclei at the envisioned HIL facility would include experiments on the structure, isomers, and decays of isotopes from Fm to Lr (Sg?). The synthesis and study of the isotopes of Bh - Mt would require much more effort and intense beams. Allowing the use of actinide targets would

substantially increase the choice of Z and N of the fusion products. A final assessment must take into account that a) studies of SH nuclei would use much (if not most) of the beam-time of the new HIL facility, and b) there are several facilities abroad where many dedicated experiments on SH nuclei will be completed before the envisioned HIL upgrade becomes operational.

4.1 Super Heavy Elements - experimental opportunities for HIL?

K.P. Rykaczewski

Oak Ridge National Laboratory, Oak Ridge, USA

The upgrade of the U-200P cyclotron currently operating at the HIL Warsaw to a high current accelerator, e.g., a DS-280 cyclotron, was proposed during the recent 2018 workshop at Kazimierz Dolny.

Potential studies of Super Heavy Elements (SHE) were considered among the attractive scientific motivations for such an upgrade. The plans for the upgrade should include the delivery of intense beams valuable for SHE research, namely ^{18}O , ^{22}Ne , ^{26}Mg , and ^{30}Si in the initial phase, and ^{36}S , ^{44}Ca , ^{48}Ca , ^{51}V , ^{54}Cr , ^{58}Fe , and ^{64}Ni for the full operation.

The investigation of very heavy nuclei, in particular new SHE and isotopes, has triggered much positive scientific and public attention. The 2019 celebrations of the 150th anniversary of the Periodic Table of the Elements as well as the addition of four new elements, Z=113 Nh, Z=115 Mc, Z=117 Ts and Z=118 Og (2016) to the Periodic Table have helped to keep interest in the physics and chemistry of SHE alive.

Among the many physics questions driving SHE studies discussed in a recent review of this field [see Rev. Mod. Phys. 91, 011001 (2019)] are:

- Where are the limits of our nuclear and atomic worlds?
- What is the extent of the region of shell-stabilized SH nuclei?
- What is the best method to produce and study new SH nuclei?
- What is the mechanism of fission likely limiting the territory of SH nuclei?
- What are the properties of the ground and excited states of SH nuclei?
- What are the atomic and chemical properties of SHE?
- Can SH nuclei be formed in the Cosmos?

While experiments aiming at the production of new SH elements and their isotopes require years of dedicated beam time and intense beams at state-of-the-art separators, some of these questions could be addressed at the earlier phase of the investigations.

I would suggest two fields of investigations as an entry to SHE physics in Warsaw. Studies of the fusion and fission mechanism in very heavy nuclei match the expertise of the HIL staff and can be continued with the upgraded detector arrays (e.g., ICAR) currently used for reaction mechanism studies. A new setup to be used in the in-beam type of studies of the fission mechanism could be constructed relatively quickly and at reasonable cost, preferably in collaboration with an experienced group like that of JAEA Tokai. While the appropriate licenses for the use of ORNL-made radioactive actinide targets at milligram quantities are needed for the long-term future, such in-beam studies of the fission

mechanism have been performed so far using targets of microgram weights, thus reducing licensing requirements.

Other research areas matching existing HIL expertise would pertain to excited states of SH isotopes, using gamma (upgraded EAGLE array) and electron spectroscopy. Such studies can be done with a few weeks to a few months of beam time. The search for new K-isomers and the investigation of their properties will profit from the expertise of Polish theory groups. However, to enter the research arena aiming at the synthesis of new SHE isotopes the construction of a Gas Filled Spectrometer should be among the priorities of the upgraded HIL (see Seweryniak's contribution).

Since the value of SHE discoveries is widely recognized, there are laboratories dedicated to SHE research and well positioned to search for new elements (JINR Dubna, RIKEN Wako). Other laboratories are upgrading (e.g., GSI Darmstadt), or expanding their capabilities (JINR, GANIL). New laboratories with SHE investigations in their future scientific portfolios are being built (HIAS China, IBC Korea).

SH nuclei research at HIL will undoubtedly profit from collaboration with these leading institutions. The joint construction of new types of detectors for SH nuclei studies followed by commissioning with HIL beams will be a valuable step. Among such detectors is the segmented ion tracking counter proposed recently by K. Miernik at the international SHE 2017 Symposium.

Clearly, identifying a local team of experts devoted to the decay spectroscopy of SH nuclei at HIL is requisite for the future of a possible experimental program in this area in Poland.

4.2 Research on Super Heavy Elements in Poland - Theoretical perspective

M. Warda

Maria Curie Skłodowska University, Lublin, Poland

Theoretical studies of super heavy nuclei give an important background for experimental discoveries of new elements. The first question that should be answered in this field by model studies is: Which super heavy isotopes live long enough to be detected? With this knowledge one has to find how they could be synthesized. Ideally, a theoretical investigation made prior to experiment should evaluate cross sections for various reactions and indicate the most efficient way of producing each isotope. The other questions for theoretical investigations concern the structure and properties of the newly created isotopes. What shapes do they have in the ground-state, what are their excited levels, are there any long-lived isomers, etc.?

The tradition of theoretical research into super heavy nuclei in Poland began with the first prediction of the shell gap at $Z=114$ and $N=184$ by A. Sobiczewski et al. in 1966 [1] and research in this field has continued since then.

There are many theoretical estimates of the evaporation residue cross sections based on various models. Usually, they divide the whole process into three steps (capture, compound nucleus formation and survival), with the probability of each step evaluated separately. The total probability is usually adjusted to the known experimental data, while

the probabilities of each step often vary by 2-3 orders of magnitude between different models. Recently, within the “fusion by diffusion” model [2, 3], possible new processes of compound nucleus cooling by alpha and proton emission have been included [4, 5].

The most important decays in super heavy elements are alpha radioactivity and fission. A lot of effort has been devoted to the proper description of spontaneous fission. Various approaches have been applied to this end: macroscopic-microscopic models [5, 6, 7] and self-consistent calculations [7, 8, 9]. The absolute values of fission barriers vary between the models but all of them agree about the regions of enhanced stability against fission. The prediction of possible super asymmetric fragment mass distributions in some super heavy isotopes around ^{284}Cn [10] requires experimental verification.

Most of the super heavy isotopes live for a very short time, usually decaying in much less than 1 s. It is a challenge to detect them in sophisticated experiments. Mechanisms that prevent a nucleus from rapid decay were considered by some theoretical investigations. In particular, it was suggested that metastable isomeric states of some isotopes may live much longer than the ground states. For example, rough estimates made in [11] for very likely high-K configurations produced alpha-decay half-lives for some of them of a few orders of magnitude longer than those of the corresponding ground states.

Experimental research on super heavy isotopes at a reconstructed Warsaw cyclotron would have strong support from theoretical groups in Poland.

References:

- [1] A. Sobiczewski, F. A. Gareev, B. N. Kalinkin, Phys. Lett. 22, 500 (1966).
- [2] W.J. Swiatecki, K. Siwek-Wilczynska, and J. Wilczynski, Acta Phys. Pol. B 34, 2049 (2003).
- [3] W.J. Swiatecki, K. Siwek-Wilczynska, and J. Wilczynski, Phys. Rev. C 71, 014602 (2005).
- [4] K. Siwek-Wilczynska, T. Cap, M. Kowal, arXiv:1812.09522.
- [5] P. Jachimowicz, M. Kowal, J. Skalski, Phys. Rev. C 82, 014303 (2010).
- [6] K. Pomorski, B. Nerlo-Pomorska, J. Bartel and C. Schmitt, Phys. Rev. C 97, 034319 (2018).
- [7] A. Baran, M. Kowal, P.G. Reinhard, L.M. Robledo, A. Staszczak, M. Warda, Nucl. Phys. A 944, 442 (2015).
- [8] M. Warda, J.L. Egido, Phys. Rev. C 86, 014322 (2012).
- [9] A. Staszczak, A. Baran, and W. Nazarewicz, Phys. Rev. C 87, 024320 (2013).
- [10] M. Warda, A. Zdeb, L.M. Robledo, Phys. Rev. C 98 041602(R) (2018).
- [11] P. Jachimowicz, M. Kowal, J. Skalski, Phys. Rev. C 98, 014320 (2018).

4.3 Recoil separators for studies of super-heavy nuclei

D. Seweryniak

Argonne National Laboratory, Lemont, USA

Studies of super-heavy nuclei (SHN) require a recoil separator. Separators used in the past to study SHN can be divided into two major groups: vacuum separators and gas-filled separators. Vacuum separators use a combination of magnetic and electric fields to separate recoiling reaction products from a primary beam and in some cases to disperse them according to their mass-to-charge state ratio. The velocity filter SHIP at GSI or the Fragment Mass Analyzer at Argonne National Laboratory (ANL) are examples of such separators. Gas-filled separators use only magnetic fields to separate the recoils from the beam. Charge-exchange reactions in the gas equilibrate the charge state of the recoils resulting in charge-state focusing and thus much higher efficiency. Gas-filled separators

used currently for SHN studies include DGFRS at Dubna, TASCA at GSI, GARIS II at RIKEN, BGS at Lawrence Berkeley National Laboratory, and RITU in Jyvaskyla. Several new recoil separators, which will be used for SHN research, were recently completed or are under construction. For example, the gas-filled separator GFS at the SHE factory in Dubna, the Argonne Gas-Filled Analyzer at ANL, which will be used in connection with the Gammasphere array of Ge detectors, or the Superconducting Super Separator at GANIL.

Almost all recent studies of SHN have used gas-filled separators because of their superior efficiency and excellent beam suppression for asymmetric reactions, which are used to produce SHN. Gas-filled separators are relatively less expensive, have a smaller footprint, and are easier to operate. Consequently, construction of a gas-filled separator for future studies of SHN with the new cyclotron is indispensable.

A specific design will be determined by the planned research. For example, in-beam spectroscopy of SHN requires a large distance between the target and the separator to accommodate a 4π Ge array and a small focal plane to facilitate efficient detection of delayed radiation. On the other hand, a search for new elements requires very intense beams and the beam suppression is an important consideration. This usually requires employing additional magnets. Important parameters of a gas-filled separator are: the acceptance solid angle, the magnetic rigidity, and the focal plane size. As part of the design, the transmission and the primary beam suppression need to be calculated/simulated for typical reactions used to produce super-heavy nuclei. Also, in order to study SHN the separator has to be equipped with a target wheel system to accommodate high beam intensities; an implantation-decay station at the focal plane based on a double-sided Si strip detector to detect SHN; arrays of Ge detectors at the target position for prompt in-beam γ -ray spectroscopy and at the focal plane for delayed γ -ray spectroscopy.

The cost of a gas-filled separator is about \$2M and the design, construction and commissioning will take at least 4 years. These estimates may vary depending on the specific design.

4.4 High-K states in heaviest nuclei

M. Kowal

National Centre for Nuclear Research, Świerk, Poland

Superheavy elements are extremely unstable systems with very low production cross sections. Existing experimental facilities limit the possibilities for discovery of new nuclides to those synthesized with cross sections above 100 fb, currently possible in selected laboratories - actually only in two of them, i.e. DUBNA and RIKEN. As the creation of new elements is a very difficult task, as a parallel or additional line of study one could try a search for new, long-lived metastable states of already known heavy nuclei. This type of research is an opportunity for smaller heavy ion laboratories such as HIL at Warsaw.

A fascinating possibility for longer life-times in very heavy nuclei is related to the K-isomerism phenomenon. Low-lying high-K configurations occur when high- Ω orbitals lie close to the Fermi energy. When such orbitals are intruders, the resulting unique

configuration may have an even longer half-life. Possible K values grow as larger-j subshells become occupied, which means for larger Z and N and is in two situations particularly very likely and can eventually be investigated.

High-K intruder states in ground states and isomeric states in odd and odd-odd nuclei

The macro-micro WS model, which has been shown to give reasonable predictions in the SH region, suggests such high-K configurations as the ground states in a number of odd and odd-odd nuclei. On the basis of systematic calculations for 1364 heavy and superheavy nuclei, including odd systems, we have found a few such candidates for high-K ground states in superheavy nuclei [1]. A particular situation occurs above the double closed subshells: N=162 and Z=108 where two intruder orbitals: neutron $\frac{13^-}{2}$ from $j_{\frac{15}{2}}$ and proton $\frac{11^+}{2}$ from $i_{\frac{13}{2}}$ spherical subshells are predicted. There are other orbitals which may produce long-lived configurations, in particular intruder neutron $\frac{11^-}{2}$ and proton $\frac{9^+}{2}$ above N=152, Z=102. There is a possibility that one such high-K ground- or low-excited state may be the longest lived superheavy nucleus. Also, one cannot exclude the possibility that such long-lived superheavy configurations have already been produced, but the setup and electronics dedicated to milliseconds measurements could not detect objects living much longer. This intriguing possibility could be checked first.

Multi-quasi particle excited states in even-even nuclei

Using the same macro-micro model, we have also found recently [2] in even-even nuclei ($106 < Z < 112$) a quite strong hindrance against alpha decay for four quasi-particle states: $K^\pi = 20^+$ and/or 19^+ . Contrary to what has been recognized so far, our analysis indicates that the alpha-decay hindrance results mainly from the proton 2 q.p. component. Due to the small structural overlap and strong centrifugal effect transitions between non-analogical states are excluded. Different excitation energies of the high-K configurations in parent and daughter nuclei thus seem particularly important for hindrance of alpha-decay. This, together with their relatively low excitation suggests the possibility that they could be isomers with an extra stability - five and more orders of magnitude longer-lived than the ground states.

This in turn would mean that chemical studies of such exotic high-K states would be more likely than for quite unstable ground states.

References:

- [1] P. Jachimowicz, M. Kowal, and J. Skalski, *Phys. Rev. C* **92**, 044306 (2015).
- [2] P. Jachimowicz, M. Kowal, and J. Skalski, *Phys. Rev. C* **98**, 014320 (2018).

4.5 Chemistry of superheavy elements

A. Bilewicz

Institute of Nuclear Chemistry and Technology, Warsaw, Poland

The chemical properties of superheavy elements (SHE) are often surprising and unexpected when simple extrapolations from lighter homologs are performed. Studies of the chemical properties of SHE provide unique opportunities to obtain insight into the influence of strong

relativistic effects on the atomic electrons and to probe “relativistically” influenced chemical properties and the architecture of the periodic table. Because of the increasing nuclear charge in SHEs, the velocity of the electrons in the inner shells approaches the speed of light. This causes a relativistic increase in the electron mass. Hence, the spherical s and $p_{1/2}$ electrons contract in space and become stabilized in energy. As a consequence, the nonspherical atomic orbitals $p_{3/2}$, d, f, and g are more efficiently screened from the nucleus, thus undergoing destabilization in energy and expansion in space. The relativistic effects scale approximately with Z^2 for valence electron shells and are thus most pronounced in SHEs. Thus, it is of great interest to study the chemical properties of SHE in detail and to compare these with properties deduced from extrapolations and from modern relativistic calculations.

Currently used research techniques allow for chemical studies of elements and their compounds at the level of individual atoms. Therefore, it is possible to study chemically even elements such as copernicium and flerovium, for which the production efficiency is about 1 atom per week.

As part of the research at the proposed new research infrastructure we propose to perform the chemical experiments listed below:

1. Continuation of our studies on the influence of relativistic effects on cation hydrolysis. We plan to investigate the hydrolysis of Cn^{2+} and Fl^{2+} cations.
2. Thermochromatographic studies of the formation of volatile chelates of Rf^{4+} , Db^{5+} and Fl^{2+} .
3. Liquid-liquid extraction studies of HsO_4 . Comparison of extraction distribution ratio with RuO_4 and OsO_4 .

The proposed studies should show how relativistic effects affect the hydrolysis of cations of the heaviest elements, the coordination number in their chelated complexes and the lipophilicity of group 8 tetraoxides.

Chapter 5

Mechanisms of nuclear reactions in simple and complex systems

Conveners:

St. Kistryn

Jagiellonian University, Kraków, Poland

and

E. Stephan

Institute of Physics, University of Silesia, Katowice, Poland

Nuclear reactions at low and medium energies provide rich information about nuclear interactions and the properties of atomic nuclei. Investigations performed with stable beams alone encompass a very wide range of beam-target systems giving insight into various aspects of nuclear dynamics. Starting from the basic interaction between nucleons, through its modification in nuclear matter and clustering phenomena in nuclei, this research also covers the mechanisms of fusion and fission reactions, including their particular phases. Certain beam-target systems are still very poorly studied while potentially very interesting, some of them should be revisited due to the availability of new experimental tools for more precise or exclusive measurements. Motivations for studies in this domain stem from advances in theories and from experimental findings and require verification in complementary systems. A thorough overview of all the important topics of such a wide field in this Report is virtually impossible. With the aim to provide a glimpse over the whole spectrum, a few specific examples of research in systems differing in complexity are selected and discussed.

The lightest systems consisting of a few nucleons are studied with the aim of thoroughly testing modern models of nuclear interactions. High precision measurements of observables in deuteron-proton systems, in particular in the elastic scattering and deuteron breakup reaction, are indispensable for exploring the role of the so-called three-nucleon force. They also constitute the ground for testing modern calculations including the Coulomb interaction or those pioneering a full relativistic treatment of the reaction, as well as forthcoming calculations based on Chiral Perturbation Theory. The studies of four nucleon systems are very interesting, among others due to a variety of possible isospin states; clearly the data base for these systems should be considerably enriched. They still suffer the lack of precise theoretical calculations at medium energies but developments in this domain are promising. It must be stressed that thorough studies of the dynamics in few nucleon systems require, in addition to the cross-section data, access to the array of polarization observables.

High-energy light projectiles colliding with atomic nuclei induce a complex sequence of processes leading eventually to the decay of nuclei, called nuclear spallation. Studies of this reaction address the basic properties of strong interactions and the properties of nuclear matter. In particular, they concern the problem of hadronic interactions within nuclear medium. Measurements with relatively low energy proton beams (70-230 MeV) would allow the investigation of the mechanism of energy dissipation within the target nucleus below the pion production threshold and in the presence of significant Pauli

blocking. They would also contribute to research into the cluster structure postulated for some atomic nuclei and permit the experimental determination of the low energy range of applicability of the spallation models. These investigations could be further extended to heavier projectiles permitting a systematic examination of the impact of compression of nuclear matter and of collective processes on the effective interaction in nuclear matter.

Another important and poorly known subject concerns the α -particle clustering in heavier nuclei. The clustering can be studied in α transfer (stripping and pick-up) reactions. The traditionally employed (${}^6\text{Li},d$) and (${}^7\text{Li},t$) reactions yield results which are notoriously inconsistent, indicating that the reaction mechanism is poorly understood. Studies should be carried out in a systematic way along isotopic chains, including reactions with heavier projectiles, like (${}^{12}\text{C},{}^8\text{Be}$), (${}^{16}\text{O},{}^{12}\text{C}$) and (${}^{20}\text{Ne},{}^{16}\text{O}$) and their inverses. The elastic scattering data should be collected in parallel.

Fusion of highly deformed nuclei of medium masses, for example ${}^{20}\text{Ne}$ and ${}^{58,60}\text{Ni}$, is considered as a basis for the investigation of barrier distributions. These studies are carried out directly by measurements of fusion or with the back-scattering method. Earlier studies with ${}^{20}\text{Ne}$ beams indicated the importance of energy dissipation via single particle excitations. The continuation of these studies with alternative methods and other nuclei is necessary to verify these observations and conclusions.

Heavy ion reactions are a wonderful playground to investigate various phenomena, such as fusion, fission, and evaporation of particles and emission of gamma rays. Fission dynamics depends on the entrance channel and conditions during the creation of the compound nucleus. During de-excitation of the hot rotating nucleus, light particles and gamma rays are emitted or, less probably, Giant Resonances are excited. Theoretical studies of pre-equilibrium states indicate several phenomena of interest, among others the pre-equilibrium emission of particles, energy dissipation or fission times. They can be experimentally approached by simultaneous detection of charged particles and γ rays. For that purpose, exclusive measurements should be carried out with the use of large acceptance detectors.

Modern stable beam facilities in Poland equipped with proton and heavy-ion accelerators would provide the opportunity for reaction research programs significantly contributing to the enrichment of the world database. It should be mentioned that some of the projects may not only need specific ions of certain energy but also impose specific requirements on the beam intensity, energy resolution, and quality of focusing. Additional features like beam polarization, though very challenging, would increase sensitivity to certain dynamical ingredients and immensely broaden the range of the research. Precise measurements of observables in nuclear reactions are also conditioned by an adequate instrumentation. General-purpose devices, like magnetic spectrometers or neutron facilities (n-TOF), when available in the accelerator center, allow for considerable enrichment of the scientific program proposed by the users. They should be complemented with modern detection systems, either dedicated or shared between several projects. In most of these cases large (or preferentially full) solid angle coverage is essential to meet the project requirements. Currently, a number of such systems is already available, for example modern γ ray detector arrays (HECTOR, PARIS) and charged particle detectors (KRATTA, BINA, FAZIA). In the table below, the needs of the specific projects are briefly summarized. More details can be found in the following sections. Here, the HIL facility denotes the new high intensity cyclotron considered for installation at HIL.

Subject	Beam	Facility	Required detection systems & other instrumentation existing / <i>desirable extension</i>
Fission (deformation, shape transition, pre-equilibrium emission)	150<A<250 e.g. ^{224}Th	HIL	KRATTA, FAZIA, HECTOR/PARIS
Barrier distribution	^{20}Ne $^{58,60}\text{Ni}$	HIL	Wien filter ICARE chamber CUDAC chamber
α clustering	high quality beams (intensity, spot size, energy resolution) $d, ^6\text{Li}, ^7\text{Li}, ^{12}\text{C}, ^{16}\text{O}, ^{20}\text{Ne}$, (8 MeV/nucleon)	HIL	<i>magnetic spectrometer</i> <i>special targets</i>
Spallation at low energies	p (70-230MeV) ions	CCB, HIL	KRATTA <i>new large acceptance detector</i>
Few-nucleon systems	p, ^3He beam polarization? neutron beam?	CCB, HIL	BINA KRATTA <i>detection system for ^3He exp. n-TOF</i> <i>magnetic spectrometer</i> <i>polarized targets</i>
Other physical cases: Isotopic ratios, Nuclear Deformation & Pre-Fission, ...	p, HI beams	CCB, HIL	FAZIA combined with γ detector arrays

5.1 Direct Reactions at Stable Beam Facilities

N. Keeley

National Centre for Nuclear Research, Świerk, Poland

A modern stable beam facility in Poland equipped with a new heavy-ion cyclotron would provide the opportunity for a significant reaction research program. Rather than attempt to cover the whole of this wide field we concentrate on a specific example of a current hot topic that would form a natural part of such a program, a systematic investigation of the evolution of α -particle clustering in fp shell and heavier nuclei [see e.g. Volya and Tchuvil'sky, Phys. Rev. C **91**, 044319 (2015)] along isotopic chains. The *absolute* magnitude of the α -particle clustering in heavier nuclei, as expressed by the spectroscopic factor S_α , remains poorly determined. Absolute values of S_α extracted from the traditionally employed ($^6\text{Li}, d$) and ($^7\text{Li}, t$) α -transfer reactions are notoriously variable, by up to an order of magnitude, indicating that the reaction mechanism is poorly understood. This may in large part be due to the fact that in these reactions most of the projectile mass is transferred,

suggesting that the underlying assumptions of standard transfer reaction theory may need to be revisited in these cases. Alternative reactions with heavier projectiles, e.g. ($^{12}\text{C}, ^8\text{Be}$), ($^{16}\text{O}, ^{12}\text{C}$) and ($^{20}\text{Ne}, ^{16}\text{O}$) have not been completely explored to date.

With a modern cyclotron these reactions could be fully investigated by collecting complete data sets – including both the entrance and exit (where feasible) channel elastic scattering angular distributions as well as the α transfer itself – along isotopic chains. Measuring full data sets would help eliminate problems associated with many previous analyses of α transfer where the non-existence of appropriate elastic scattering data leads to *ad hoc* adjustment of the distorting potentials and consequent uncertainty as to whether any trends observed in the extracted S_α are real physical effects or simply spurious.

The increased beam current, excellent energy resolution and smaller beam spot size of a modern cyclotron would enable the measurement of angular distributions for, e.g., the $^{40}\text{Ar}(^6\text{Li},d)$, $(^7\text{Li},t)$, ($^{16}\text{O}, ^{12}\text{C}$) and ($^{20}\text{Ne}, ^{16}\text{O}$) reactions and their inverses – with the exception of ($t, ^7\text{Li}$) – at beam energies of about 8 MeV/nucleon, a “typical” heavy-ion cyclotron energy, with high absolute accuracy (cross sections would be of the order of 0.1 mb/sr at forward angles). Such a data set would not only form the basis for an accurate probe of the extent of α -particle clustering in both ^{40}Ar and ^{44}Ca but also enable comparisons between the different reactions to determine the “best” α transfer.

Equipment required in addition to a modern heavy-ion cyclotron, to provide more intense beam current and good beam energy resolution and small beam spot size, would include the use of gas cell or implanted targets (for gaseous elements like Ar) and possibly a vacuum target lock to enable targets prepared under vacuum to be transferred to the scattering chamber (e.g. metallic Li targets if inverse kinematics is desirable or if metallic Ca targets are required) and a magnetic spectrometer. The latter is essential for accessing excited states with the necessary resolution and also if implanted targets are used with the heavier projectiles in order to eliminate elastic scattering from the foil. It would also enable a much closer approach to 0° than is possible with silicon detector arrays, greatly facilitating the analysis.

5.2 Dynamics of fission in phenomenological models

K. Mazurek, A. Maj, M. Kmiecik et al.

The H. Niewodniczański Institute of Nuclear Physics PAN, Kraków, Poland

Heavy ion reactions are a wonderful playground to investigate various phenomena, such as fusion, fission, evaporation of particles, emission of gamma rays and others. The fission dynamics depends on the entrance channel and conditions during the creation of the compound nucleus. During de-excitation of the hot rotating nucleus light particles and gamma rays are emitted. Less probable is excitation of Giant Resonances and their de-excitation.

Phenomenological models such as HIPSE (Heavy-Ion Phase-Space Exploration) (D. Lacroix et al. Phys. Rev. C69, 054604 (2004)) give a description of compound nucleus production, taking into account the pre-equilibrium emission of particles. Dynamical models based on solving a transport equation of Langevin type, in the multidimensional space of the collective coordinates (K. Mazurek, P. N. Nadtochy, E. G. Ryabov, G. D. Adeev, Eur. Phys. J. A, 53 (2017) 79) estimate correctly the evaporation and fission

channels. Study of the pre-equilibrium particle emission is crucial for a discussion of the de-excitation of hot nuclei. Fission, evaporation observables are estimated by coupling HIPSE pre-fragments with statistical (GEMINI++) and dynamical (4DLangevin) de-excitation codes. Preliminary calculations of the influence of the pre-equilibrium emission on the shape of the GDR strength function (see Fig.1) have been made with the Thermal Shape Fluctuation Model (N. Dubray, J. Dudek, A. Maj, Acta Phys. Polon. B 36, 1161 (2005)).

Combined measurements of the fission fragments and of emitted particles and gamma rays coming from the de-excitation of heavy/superheavy nuclei allow the study of:

- changes of deformation on the way to fission (GDR measurement with the use of such detector arrays as HECTOR or PARIS);
- shape transitions: evolution of symmetric-asymmetric fission with increasing angular momentum; Poincare transition (fission fragment mass/charge distribution, GDR)
- pre-equilibrium emission (high-energy gamma rays, charged particle multiplicities and energy spectra, fission fragments mass/charge distributions – measured using such detector arrays as PARIS, KRATTA, FAZIA)
- energy dissipation and viscosity parametrization (angular correlation between fission fragments and gammas)
- fission times (angular correlation between fission fragments and gammas).

We propose to study the phenomena listed above in nuclei from the mass region $150 < A < 250$, for example ^{224}Th , at the Heavy Ion Laboratory, University of Warsaw, after an upgrade of the facility by purchasing a new cyclotron which can accelerate heavy-ion beams up to Bi with a bombarding energy of at least 10 A MeV.

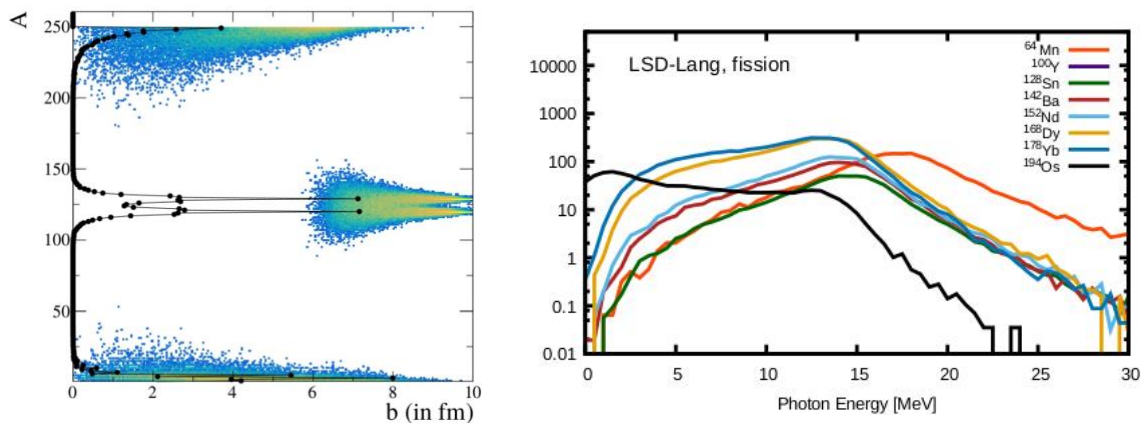

Fig.1 (Left) The distribution of nuclei after pre-equilibrium emission for the reaction $\text{Xe}+\text{Sn}\rightarrow\text{Rf}$ at 12 A MeV. (Right) The Giant Dipole Resonances obtained by de-excitation of various nuclei in the fission channel.

5.3 FAZIA - Status, Perspectives for Installation and Possible Physics Case in Poland

S. Upadhaya

Jagiellonian University, Kraków, Poland

The aim of the FAZIA project is the design and construction of a charged particle detector with high resolution and low thresholds which can be used with both stable and radioactive beams in the range 10 – 100 MeV/nucleon. A single detection element consists of 2 Silicon detectors (300 μm and 500 μm) and a CsI crystal (10 cm). These detection elements are placed in a 4x4 matrix to constitute a single block. Several European institutions are involved in the project and the R&D phase (concerning detectors, electronics and identification techniques) started in 2006. FAZIA is presently in demonstrator phase which consists of 12 FAZIA blocks (see Fig.2) and is being coupled with the INDRA detector at GANIL, France.

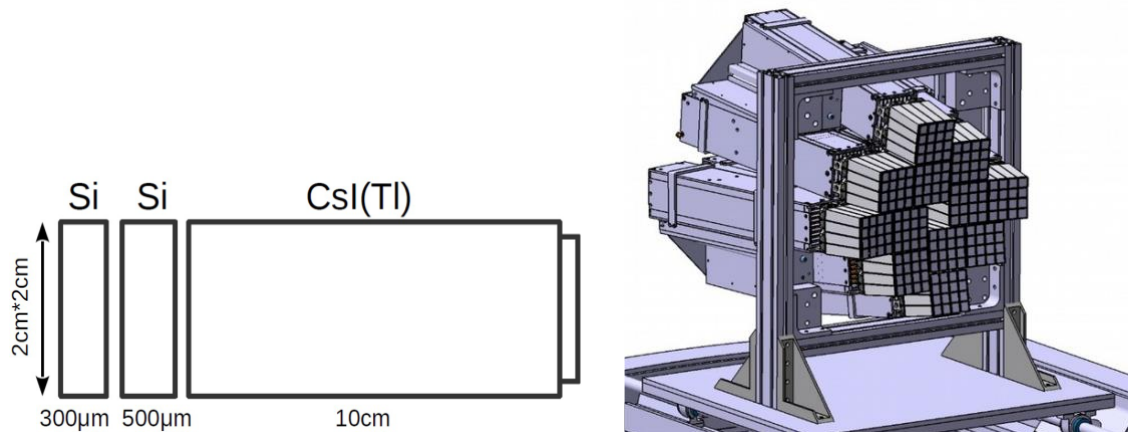

Fig.2 Techniques for charge and mass identification of reaction products were obtained by means of a systematic study of the basic detection module. Significant improvements in $\Delta E-E$ and pulse-shape techniques were obtained by various methods. The good identification quality obtained with the prototypes during the R&D phase allowed us to investigate also some aspects of isospin physics such as isospin transport phenomena.

All the previous work demonstrates the very good capabilities of FAZIA in terms of charge and mass identification with low thresholds. FAZIA is designed in such a way as to be easily movable and coupled to other apparatus in order to permit a very rich scientific program exploiting various stable and radioactive beam facilities. This portability gives rise to great future prospects for collaborative work. Also, a collaborative experiment with FAZIA and some pieces of the GARFIELD detector was performed with proton beams at the CCB at IFJ-PAN, Krakow in November 2018.

5.4 Barrier distributions

A. Trzcńska

Heavy Ion Laboratory, University of Warsaw, Warsaw, Poland

An investigation of barrier distributions (BD) is a long-lasting project of our group. Our studies performed at HIL were focused on ^{20}Ne as a projectile. We have used the back-scattering method in order to determine BDs.

According to the predictions of the Coupled Channel (CC) Method, the properties of such an extremely deformed projectile should determine the shape of the barrier distribution for systems consisting of ^{20}Ne and any target. Due to the deformation of the projectile, the BD of such systems should have a specific structure with two apparent maxima. Our studies have shown that only for a few systems are the predictions of the CC calculations confirmed by experimental results. In other cases studied the predicted structure of the BD was smoothed out.

The discrepancy can possibly be explained by the non-collective reaction channels (single particle excitations in the case of nuclei with high level density or transfers in systems with high transfer cross sections) neglected in the standard CC calculations. In certain systems studied by us, transfer reactions cannot be responsible for the BD smoothing. According to our hypothesis, the BD smoothing in such systems is caused by partial dissipation of kinetic energy into heat of the system (single particle excitations). The proper treatment of such “open systems” requires a consideration of the energy dissipation.

The results described above triggered development of new theoretical calculations including single particle excitations in the description of such cases (K. Hagino, S. Yusa and N. Rowley, Phys. Rev. C 82, 24606 (2010)). The influence of single particle excitations on the fusion process seems to be confirmed by calculations performed with the use of a code merging CC and Random Matrix Theory (RMT) approaches.

As a next step we are going to measure directly the fusion reaction and investigate the influence of dissipation on this process. To this end we will use the Wien Filter (velocity filter) recently built in collaboration with LNS Catania. The device is under test and should be ready for use in experiments at the end of 2019. Use of the Wien Filter will allow for measurements of the fusion excitation functions and direct studies of the influence of dissipation on the fusion process. Further in the future we plan to install the Wien filter in the appropriately adapted ICARE chamber at the HIL facility.

A new version of the CUDAC scattering chamber (a compact device, of ~ 50 cm diameter) designed for back-scattering measurements of barrier distributions is ready. In the improved chamber the detectors are placed not only at backward angles (in the laboratory frame) but also at ~ 60 degrees. Provided a Ni beam can be delivered at HIL, it would allow use of the back-scattering method to study the BD for semi-symmetrical systems like $^{58}\text{Ni}+^{60}\text{Ni}$. The barrier distribution for these systems was studied in 1995 by A.M. Stefanini *et al.* with the fusion method. It would be interesting to check whether the structure they observed in the fusion barrier distribution will also be observed in our measurements of back-scattering.

5.5 Few-body reactions

I. Skwira-Chalot

for the Collaboration of UW, UŚI, KVI-CART, IFJ, UJ

Faculty of Physics University of Warsaw, Warsaw, Poland

Existing nucleon-nucleon (NN) interaction models are able to describe the bulk of all NN data with the highest accuracy. The comparison of these high-quality calculations with precision experimental data for three nucleon systems strongly suggests that additional dynamics, the three-nucleon force, plays an important role modifying the experimentally measured observables. The Coulomb interaction between protons and relativistic effects also need to be included in the theoretical description. Even if the theoretical and experimental improvements are both impressive, there still remain unresolved puzzles which indicate that our understanding of the complexity of forces acting in the few-body system is not complete.

Three nucleon (3N) systems have been widely tested experimentally in many laboratories, though mainly in proton-deuteron elastic scattering and even in this case certain polarization observables are poorly known. Systematic investigations of the deuteron breakup reaction (in collision with protons) were started at KVI, Groningen with the use of the SALAD and BINA detectors and since 2012 they have been continued at the Cyclotron Center Bronowice (CCB), PAS, Kraków where the BINA detector (Fig.3, Left panel) was installed. The ongoing project aims to study the three nucleon systems over a wide range of energy with the use of a detector with almost 4π acceptance. Using a proton beam and deuteron targets (liquid or solid) the differential cross sections for elastic scattering and deuteron breakup are measured at energies of 108, 135 and 160 MeV (Fig.3, Right panel, shows preliminary results from the first data taking run at 108 MeV). Collected experimental data give the opportunity to study the magnitude of dynamic effects like three nucleon (3N) and Coulomb forces.

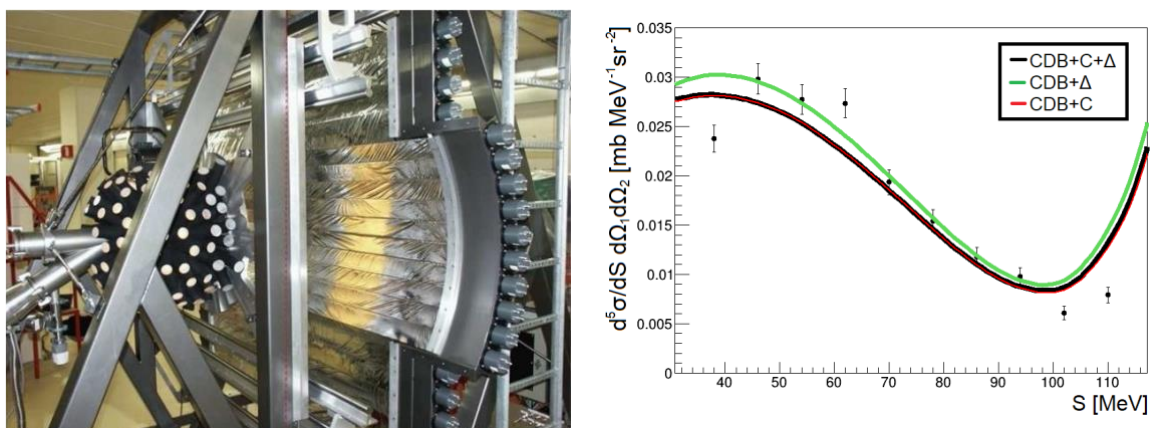

Fig.3 (Left) Photo of the BINA system. (Right) Preliminary differential cross section for one configuration ($\theta_1=16^\circ$, $\theta_2=28^\circ$, $\varphi_{12}=160^\circ$) of the dp breakup reaction at 108 MeV (theoretical calculations by A. Deltuva).

Relativistic effects modify the cross sections for specific configurations of the $^2\text{H}(p,pp)n$ breakup reaction even at energies as low as 65 MeV. At a beam energy of 200 MeV the predicted magnitude of the effect reaches 60%, in certain configurations reducing and in others increasing the cross-section value (H. Witała et al., Phys. Rev. C 83 (2011))

044001). This prediction motivated an experimental project dedicated to the measurement of the breakup reaction in the angular region particularly sensitive to the relativistic effects. The experiment will be carried out at CCB with the use of the 200 MeV proton beam, a solid deuterium target and the KRATTA detection system.

The natural next step of this research involves investigations of four-nucleon (4N) systems, potentially more sensitive (than 3N systems) to the 3N force and providing the opportunity for studies of isospin dependencies. The variety of input and output channels comprise a wide ground for thorough studies of the dynamics, but the same feature makes the theoretical calculations for 4N systems very challenging. In spite of the lack of ab-initio calculations at medium energies, recent developments in this domain motivate experimentalists to start building a systematic 4N database. The project proposed for realization at CCB relies on the reaction in which a proton beam of 60 MeV collides with an (un)polarized ^3He target. Both elastic scattering and breakup of ^3He will be measured to study dynamic effects (3NF, Coulomb force) in the differential cross section and analyzing powers.

5.6 Nuclear spallation

K. Pysz

The H. Niewodniczański Institute of Nuclear Physics PAN, Kraków, Poland

Studies of nuclear spallation i.e. the processes governing the decay of atomic nuclei after their collision with a high-energy light projectile, address the basic properties of strong interactions and nuclear matter. In particular, they concern the problem of hadronic interactions in nuclear matter – how the surrounding medium (its density, excitation) modifies these interactions. As a result of a spallation reaction complex charged particles with high energies (significantly exceeding the energies typical of evaporation processes) are produced with high abundance. Their formation mechanism is unknown. This issue is probably related to the hypothesis of nuclear clusterization, either dynamic or static, which seems to play an important role in processes typical for both low- and high energy interactions.

During the nuclear spallation reaction various phases take place, which differ in their dynamics. Thus, their theoretical descriptions should also be different. Up to now there is no satisfactory theory which can in general describe this type of interaction. The current understanding of intra-nuclear interactions does not allow for a detailed description of processes occurring at high energies (100 MeV - several GeV) in a multi-body and excited quantum system. In order to understand the existing experimental data, microscopic models are created. They contain a certain amount of well-established knowledge about atomic nuclei supplemented by a number of assumptions and simplifications. Currently existing models reproduce qualitatively only simple quantities such as the multiplicities of particles or their total production cross sections. In the case of more complicated observables, such as the energy and angular distributions of reaction products, the predictions of theoretical models are significantly different from the experimental data.

Spallation experiments at low energies (70-230 MeV) such as those available at the Cyclotron Centre Bronowice at the Institute of Nuclear Physics PAN (CCB IFJ PAN), would be complementary to research conducted with higher energy proton beams in other European Laboratories. They would allow an investigation of the mechanism of energy

dissipation within the target nucleus below the pion production threshold and in the presence of significant Pauli blocking. They would also contribute to research on the cluster structure postulated for some atomic nuclei and permit the experimental determination of the low energy range of applicability of spallation models.

Experimental research on low-energy nuclear spallation mechanisms is possible with the existing experimental infrastructure at the CCB IFJ PAN. Apparatus available there allows the identification of reaction products and registration of their energy spectra. However, from the point of view of the development of theoretical models it would be recommended to extend the research program by studies of correlations between the emitted products. Therefore, the registration of coincidences between them has to be assured. For this purpose, the detector system should be expanded with new detectors in order to increase its total acceptance. The optimal new detectors would be built of telescopes consisting of a thin- and thick silicon detector followed by a scintillator counter of a thickness enabling 230 MeV protons to be stopped.

In the longer term these studies could be continued with beams of heavier projectiles produced in the new cyclotron at the Heavy Ion Laboratory (HIL) in Warsaw. This should permit a systematic examination of the impact of the compression of nuclear matter and collective processes on the effective interaction in nuclear matter. This research could help to understand the differences between the processes acting in light and heavy ion collisions.

Chapter 6

Gamma spectroscopy

Conveners:

J. Srebrny

Heavy Ion Laboratory, University of Warsaw, Warsaw, Poland

and

P. Bednarczyk

The H. Niewodniczański Institute of Nuclear Physics PAN, Kraków, Poland

Discrete gamma ray spectroscopy is a unique and powerful tool to investigate the structure of the atomic nucleus. It provides precise information on excited nuclear states through measuring the properties of the gamma-transitions emitted in their decay. The measured quantities include: the transition energy, electromagnetic character, decay lifetime, and multiplicity and coincidence relations. Based on this information, a detailed level scheme of a nucleus of interest can be constructed that contains invaluable information on the single-nucleon and collective motion of the atomic nucleus. Nuclear structure studies along the nuclear chart are crucial for the development of a comprehensive nuclear theory framework.

Nuclei in excited states can be populated in various nuclear reactions. The most efficient ones are: inelastic Coulomb scattering, fusion-evaporation, and nucleon transfer reactions induced by accelerated ion beams. The reaction products mainly decay through prompt particle emission at high excitation energy, and through gamma rays below the particle emission thresholds. Intense EM radiation induced in the nuclear collisions constitutes a gamma-ray background that makes the rare sequences of photons caused by exotic decay branches, which are of particular interest for nuclear structure studies, difficult to see. Therefore, in order to extract the associated gamma spectra, sensitive spectrometers are necessary. Such instruments used nowadays are arrays of Compton suppressed HPGe detectors characterized by high values of the photopeak detection efficiency, energy resolution, and ratio of the photo-peak to the Compton background. The combination of these parameters allows the resolution of weak cascades of gamma transitions. The gamma tracking arrays currently being developed will be characterized by a significant increase in resolving power. In this respect the possibility of selecting a particular weak reaction channel by simultaneous detection of the reaction products (light particles or heavy recoiling nuclei) will be of great importance.

There are two complementary accelerator centers in Poland where nuclear structure studies by means of in-beam gamma-ray spectroscopy have been carried out: at IFJ PAN in Kraków and at HIL University of Warsaw. At IFJ PAN, light projectiles (protons and alpha particles) have been available for experiments since the late 1950s. Recently, the new PROTEUS 235 cyclotron can provide intense proton beams over a wide range of energies from 70 MeV to 235 MeV that can be used, among other things, to populate highly excited nuclear states in various targets emitting gamma rays. On the other hand, at HIL UW the U-200P cyclotron has accelerated ion beams of various isotopes of elements ranging from boron to argon to energies of up to 10 MeV per nucleon. Among the detector setups available at HIL for in-beam experiments is the medium sized gamma-ray spectrometer

EAGLE, consisting of up to 20 Compton suppressed Ge units. It is one of the few such devices currently operating in European accelerator laboratories. The EAGLE array has been used in many gamma spectroscopy experiments, primarily exploiting Coulomb excitation (COULEX), a specialty of the Warsaw group. Experimental groups around EAGLE also have expertise in precise measurements and comprehensive analysis of many quantities that give insight into the internal structure of atomic nuclei:

- magnetic dipole moments,
- electric quadrupole moments,
- lifetimes of nuclear states over a broad range from 10^{-13} s to 10^{-2} s, measured by various methods, in particular based on the Doppler-shifted gamma rays (DSAM and RDM),
- multipolarity of electromagnetic transitions determined by simultaneous measurements of internal conversion electrons and gamma rays and by γ - γ angular correlations
- reduced E2, M1 and E3 matrix elements which contain information on nuclear shapes and collectivity.

Our experience and longstanding tradition of in-beam gamma spectroscopy justify the plans to launch a national facility based on a new heavy ion cyclotron - DC 280 at HIL UW. Such an accelerator providing very intense heavy beams up to ^{209}Bi should be combined with a large acceptance mass separator for the reaction products. In addition, use of modern detection systems such as the AGATA gamma-ray spectrometer coupled to neutron (NEDA) and electron (ULESE) spectrometers, complemented by ancillary devices for lifetime determination, would allow the range of nuclear structure studies performed in Poland to be extended. The new high-current beams will broaden significantly the spectrum of experiments performed at HIL UW, especially those employing the Coulomb excitation method.

A new heavy ion accelerator at HIL UW, offering high-intensity stable beams, combined with modern nuclear radiation spectrometers and high transmission mass separators, would offer an opportunity to perform nuclear structure studies, including investigations of very heavy nuclei, at an internationally competitive level. The broad expertise of Polish nuclear physicists in building instrumentation and in nuclear structure investigations by means of gamma and particle spectroscopy, together with their unique competences, will guarantee successful operation and the best quality scientific output of this anticipated experimental facility in Warsaw.

In the following contributions a short overview is given of various devices being considered for future gamma-spectroscopy experiments and a summary of the relevant methods.

6.1 AGATA -Advanced Gamma Tracking Array

P. Bednarczyk

The H. Niewodniczański Institute of Nuclear Physics PAN, Kraków, Poland

AGATA (Advanced GAMMA Tracking Array) is the biggest project concerning R&D on nuclear radiation detectors pursued in recent years in Europe [1]. Its objective is to build and operate a 4π γ -ray spectrometer which will be a homogenous shell made of 180 HPGe 36-fold electrically segmented crystals capable of detecting photons with unprecedented efficiency and sensitive to the impact position with a precision of 1 mm. This is achieved thanks to fast fully digital readout electronics which enable detailed pulse shape analysis of the electrical signals generated by a photon passing through a Ge crystal. Complex evaluation of these signals simultaneously collected from many segments, referred to as gamma tracking, provides information on the trajectory and full energy of the detected gamma ray, thus minimizing the Compton background and maximizing the absolute detection efficiency, which in the final stage of AGATA will reach 70%. Due to the extensive cost and demanding HPGe crystal production technology the detector is being implemented in phases. In 2009 the AGATA Demonstrator (AD) consisting of 15 HPGe crystals was installed at the LNL laboratory in Italy to prove the gamma tracking concept in-beam. AD was also used at LNL to perform the first physics experiments. Since then, the array has been gradually augmented with new detectors and used in experimental campaigns in other European laboratories such as GSI in Germany (2012-2014) and now at GANIL in France (Fig.1). AGATA currently comprises 45 crystals and covers a solid angle of 1π .

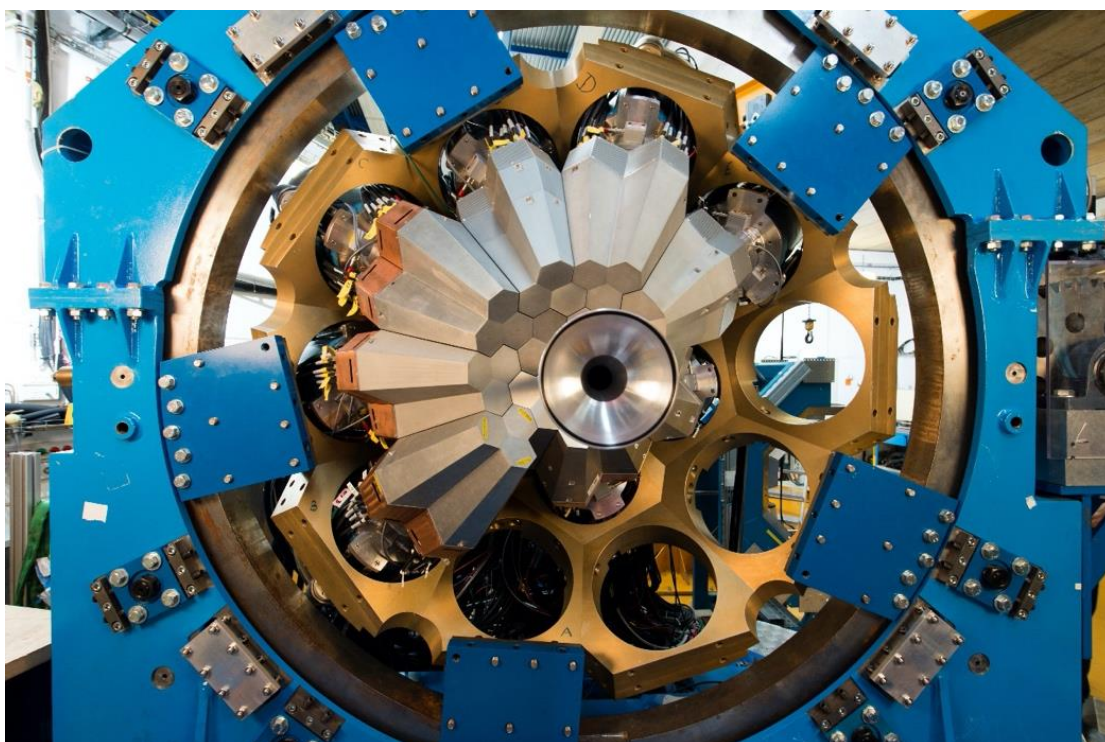

Fig.1 Part of the AGATA array (corresponding to approximately 1π of solid angle) installed at GANIL, France. Photo by P. Stroppa (CEA), <https://www.ganil-spiral2.eu/press/>

It is foreseen that in the forthcoming decade the project will be completed and will serve the European nuclear physics community to perform high precision γ -ray spectroscopy experiments at various European laboratories. The most challenging programs presume the use of radioactive ion beams in France at GANIL- SPIRAL, Italy at LNL- SPES and Germany at GSI/FAIR – NUSTAR [2]. Poland has participated in the AGATA project from the very beginning. We have developed some components of the array electronics and its ancillary particle detectors which are mandatory to increase the overall sensitivity of AGATA. Our groups have proposed and performed experiments in the AGATA host laboratories and have contributed to the operation of the array. In the future one may also consider hosting the AGATA array at HIL UW in order to exploit the unique opportunities for γ -ray spectroscopy studies provided by the planned new heavy-ion cyclotron. Of particular interest will be the possible use of the array in experiments aimed at high spin spectroscopy of very deformed nuclides from the $A=40$ -70 mass region, low spin structure investigated in Coulex experiments, for example in the Cd isotopic chain, or γ -ray spectroscopy of the very heavy transfermium nuclei. In order to prepare the Polish nuclear physics community to host in the future at HIL UW such a modern γ -ray spectrometer (AGATA or similar), it would be very desirable to establish here a dedicated laboratory for the maintenance and development of position sensitive HPGe detectors.

References:

- [1] S. Akkoyun *et al.*, Nucl. Instrum. Methods A, 668 (2012) 26.
- [2] W. Korten *et al.*, Eur. Phys. J. A, 56 (2020) 137.

6.2 NEDA - NEutron Detector Array

G. Jaworski

Heavy Ion Laboratory, University of Warsaw, Warsaw, Poland

NEDA (NEutron Detector Array) is a next generation neutron detection system designed to be a versatile device, with high-detection efficiency, excellent neutron-gamma discrimination and high rate capabilities [1]. The primary application of NEDA is to serve as a multiplicity filter of fast neutrons, operating in conjunction with state-of-the-art γ -ray spectrometers such as AGATA [2,3], with the purpose of identifying neutron-evaporating reaction channels at very low cross sections. Large arrays of liquid scintillator detectors like the Neutron Wall [4,5] and the Neutron Shell [6] were constructed in the past and successfully used in many experiments, aimed at the study of more and more neutron deficient nuclei, especially along and close to the $N = Z$ line, up to the region of the doubly magic ^{100}Sn . The existing devices are rather well suited for the detection of a single or at most two evaporated neutrons, achieving efficiencies of about 20% and 2%, respectively. However, the efficient identification of events with higher neutron multiplicity is difficult, since it requires both large granularity of the array and excellent neutron-gamma discrimination capabilities. The NEDA array has been designed to fulfill such requirements. From the very beginning group from the University of Warsaw has contributed to the construction of NEDA and to the detector installation at GANIL in 2018. We subsequently proposed and run experiments employing the combined NEDA and AGATA systems (see Fig.2). Possible use of the NEDA in combination with a highly efficient γ spectrometer at HIL UW, operating with high current beams of the new heavy-ion cyclotron, would enable studies of exotic neutron-deficient nuclei at and beyond present feasibility limits.



Fig.2 The NEDA array at GANIL, France, photo by J. Nyberg, <https://www.agata.org>

References:

- [1] J. Valiente et al., Nucl. Instrum. Methods Phys. Res. Section A, 927 (2019) 81.
- [2] S. Akkoyum et al., Nucl. Instrum. Methods Phys. Res. Section A, 668 (2012) 26.
- [3] E. Clément et al. ,Nucl. Instrum. Methods Phys. Res. Section A, 855 (2017) 1.
- [4] Ö. Skeppstedt et al. ,Nucl. Instrum. Methods Phys. Res. Section A, 421 (1999), 531.
- [5] J. Ljungvall et al. ,Nucl. Instrum. Methods Phys. Res. Section A, 528 (2004), 741.
- [6] D.G. Sarantites et al. ,Nucl. Instrum. Methods Phys. Res. Section A, 530 (2004), 473.

6.3 ULESE - University of Lodz Electron SpEctrometer

J. Perkowski

University of Łódź, Łódź, Poland

ULESE (University of Lodz Electron SpEctrometer) was designed and constructed for in-beam measurements and is characterized by high efficiency up to 12% for 300 keV electrons, good energy resolution $< 1\%$ at 1 MeV and good suppression of delta electrons, positrons and photons emitted by the target [1]. This achievement was obtained using a combination of a magnetic field in two different layouts: perpendicular and parallel to the axis of the spectrometer which is orthogonal to the beam line. The ULESE spectrometer (see Fig.3) coupled to the EAGLE array was successfully used in measurements performed at HIL UW. The main goal of these experiments was to study the violation of the K selection rule for electromagnetic transitions in nuclei. Coincidence gamma-electron measurements allowed the determination of the internal conversion coefficients and, in consequence, the absolute transition probabilities in, for example, ^{130}Ba , ^{132}Ce , ^{134}Nd and ^{184}Pt . Such a device combined with a new generation γ -ray spectrometer would be particularly useful for studies of the structure of super heavy nuclei, emitting gamma and beta radiation or internal conversion electrons. Of special interest are investigations of K isomers in super-heavy nuclei and the search for fully converted E0 transitions in heavy nuclei, revealing shape coexistence. In the future spectrometry of low energy electrons (5 - 100 keV) emitted from heavy reaction products selected in a magnetic separator is also

being considered. This could play an important role in studies of super-heavy nuclei, especially in Coulomb Excitation experiments.

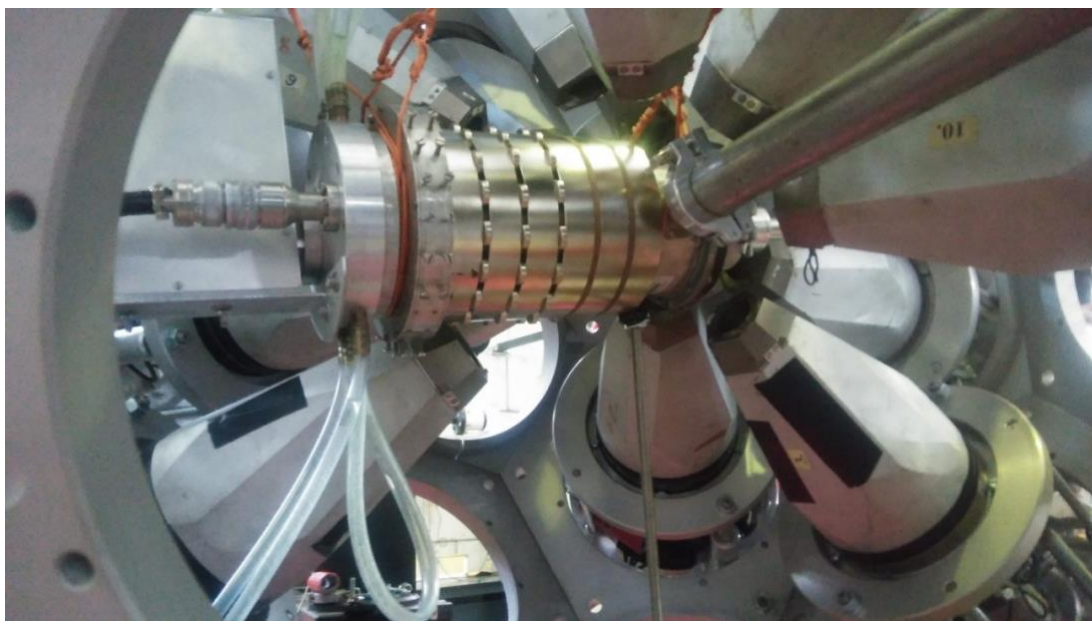

Fig.3 The electron spectrometer ULESE mounted inside the EAGLE Ge detector array at HIL UW

References:

[1] J. Perkowski et al., Rev. Sci. Inst. 85 (2014) 043303.

6.4 Plunger for lifetime measurements in inverse kinematics reactions

K. Starosta

Simon Fraser University, Burnaby, Canada

Electromagnetic transition rates are recognized as critical observables for the evaluation of nuclear structure effects and verification of nuclear models. They can be directly extracted from measurements of lifetimes of the emitting states in a way fully independent of the reaction and excitation mechanisms. Methods based on the Doppler-shift of a gamma line, such as the Doppler Shift Attenuation Method (DSAM) or the related Recoil Distance Method (RDM) are suitable to measure short lifetimes in the range of a few femtoseconds to hundreds of picoseconds. They can be particularly effective if combined with inverse kinematics reactions, as the high speed of the heavy projectile impinging on the lighter target results in a fast recoil and causes substantial Doppler shifts. An interesting application is the use of RDM in projectile Coulomb excitation reactions. The TIGRESS Integrated Plunger (TIP) has been constructed at the Simon Fraser University to be used with the TIGRESS segmented Ge detector array at the TRIUMF ISAC-facility [1]. TIP is designed to achieve control of sub-micrometer shifts between target and degrader and can be run in a self-standing mode or in tandem with a CsI array of charged particle detectors for reaction channel selection from fusion-evaporation reactions. A compact CsI array with digital readout has been developed as part of the TIP facility and may be run without the plunger using the TIP vacuum vessel in spectroscopy and DSAM experiments. TIP is also designed to be coupled with the forthcoming TIGRESS auxiliary deuterated neutron detector array DESCANT and the electromagnetic spectrometer EMMA. The lifetime

of the 2^+ Coulomb excited state in a ^{84}Kr beam at 250 MeV was successfully measured with TIP and the high performance of the proposed method was demonstrated. At HIL a similar setup could be implemented and Coulex experiments in inverse kinematics be carried out taking advantage of the large range of high current heavy beams delivered by the new accelerator.

References:

[1] P.Voss et al., Nucl. Instrum. Methods Phys. Res.A 746, (2014), 87.

6.5 Lifetime determinations with fast timing scintillators and g-factor measurements

E. Grodner

National Centre for Nuclear Research, Świerk, Poland

Advanced studies of the chiral symmetry breaking in low energy excitations of atomic nuclei have been carried out at HIL and become a specialty of the Warsaw group. To investigate the chiral bands with the EAGLE HPGe array, gamma spectroscopy techniques have been applied such as the DSAM for lifetime measurements [1], [2] and the time-differential perturbed angular distribution (TDPAD) to determine g-factors [3]. In the TDPAD method the nuclear magnetic moment interacts with external an magnetic field which results in its precession around the field axis and causes a specific angular distribution of the emitted gamma radiation, therefore a successful measurement of this type requires angular sensitivity of the gamma spectrometer. A good example of such an application at HIL is a very recent search for a phase transition from not-chiral to chiral structure in ^{128}Cs . However, the further development of this research line requires new technology to determine lifetimes. Lifetimes of the order of hundreds of picoseconds can be extracted using a technique based on the fast-timing properties of new scintillators, such as LaBr_3 . This method takes advantage of the simultaneous acquisition by the fast scintillators of two consequent gamma transitions, feeding and de-exciting the state of interest. Usually, in order to select this particular gamma decay branch, coincidences with another γ -rays characteristic of a given nucleus are required. This condition can be assured when a Ge array used. At HIL in collaboration with NCBJ, the EAGLE HPGe array was combined with EYE (sEquential gamma raYs dEtecton) (see Fig.4), that is a set of 24 LaBr_3 scintillators provided by the FATIMA collaboration. Successful lifetime measurements in middle mass $A\sim 130$ nuclei revealing chirality, performed recently with this setup could in future be extended to very heavy systems that will be available for studies at the new cyclotron. Heavy, intense beams from this accelerator, together with the application of high temperature superconductor targets that can induce strong magnetic fields, will also offer new opportunities concerning magnetic moment measurements in inverse kinematics experiments.



Fig.4 The EAGLE-EYE arrays for fast timing measurements at HIL UW

References:

- [1] E. Grodner et al, Phys. Rev. Let.97,172501(2006).
- [2] E. Grodner, I. Sankowska et al., Phys. Lett. B, 703(2011) 46.
- [3] E. Grodner et al., Phys. Rev. Let. 120, 022502 (2018).

6.6 Nuclear structure studied with Coulomb excitation

P. Napiorkowski, K. Wrzosek

Heavy Ion Laboratory, University of Warsaw, Warsaw, Poland

The Heavy Ion Laboratory of Warsaw University is a world class center for performing Coulomb excitation (COULEX) experiments [1]. The team established at HIL UW by Tomasz Czosnyka in collaboration with Doug Cline from the University of Rochester has developed a Semiclassical coupled-channel Coulomb excitation least-squares search code – GOSIA [2] – that is considered worldwide as the main tool in the complex analysis of COULEX experimental data.

Amongst many different and complementary techniques used to study nuclear structure, Coulomb excitation brings substantial and unique information detailing nuclear deformation. Scattering of ion beams at kinetic energies below the Coulomb barrier (a few MeV per nucleon) allows for selective excitation of low-lying states in both projectile and target nuclei with a pure electromagnetic interaction. This process is well accounted for by the theory enabling easy modeling of experiments and accurate data interpretation. In multistep Coulomb excitation experiments, when several states are populated, a number of matrix elements affect the Coulomb-excitation cross section in a complex way. The contributions from various excitation paths depends on the beam and target atomic numbers and vary with the projectile scattering angle. Differential measurements of the Coulomb-excitation cross section make it possible to disentangle them and gain

sensitivity to the subtle higher-order effects, such as the relative signs of the electromagnetic matrix elements and spectroscopic quadrupole moments.

Detailed spectroscopy of the gamma rays emitted in the subsequent decay together with detection of the scattered projectiles provides a direct measure of the non-diagonal and diagonal electromagnetic matrix elements including their signs.

Based on this experimental information various moments describing nuclear deformation can be extracted for each excited state, independently of nuclear models, using the quadrupole sum rules method [3]. The method is particularly useful for attributing shape parameters to low-lying 0^+ states. The study of the low-energy electromagnetic structure of atomic nuclei with Coulomb excitation has been a long-standing task of our group. One of the main topics of our recent studies performed at HIL was focused on the transitional region of the nuclear chart ($A \sim 100$, $Z \sim 40, 50$), where shape instabilities are relatively common and may lead to coexisting nuclear shapes. Most of the even-even nuclei in this region are also traditionally considered as the best examples of vibrational nuclei. However, recent results seriously contradict this simple interpretation. Moreover, in this mass region triaxiality is expected to play an important role as evidenced by our Coulomb excitation studies of shape-coexisting structures in $^{96,98,100}\text{Mo}$ [4]. Detailed Coulomb excitation studies are surprisingly scarce and critically needed in this region of the nuclear chart to move towards a resolution of the most fundamental question "What is the nature and origin of low-energy collectivity in these nuclei?". The aim of future projects is to perform extensive multi-step Coulomb excitation studies to extract a rich and complete set of reduced diagonal and non-diagonal matrix elements in stable nuclei. Combining such rich Coulomb excitation data sets will consequently yield shape parameters, including triaxiality, and even opens the possibility of describing their softness. Therefore, such detailed and comprehensive Coulomb excitation studies require: (i) various ion beam of differing atomic number, (ii) a new, dedicated experimental set-up equipped with a particle detector covering a broad angular range.

In the region of the heaviest nuclei various collective phenomena can be observed: nuclear deformation, ranging from spherical to prolate and oblate shapes with the possible occurrence of triaxial symmetries and superdeformation, collective octupole excitations and high-K isomers. The Coulomb excitation technique, which is widely used to study collectivity of stable and unstable nuclei, has been applied to a few heavy cases only (e.g. ^{248}Cm).

For the past two decades a significant development of the Coulomb excitation method has been achieved in order to meet the requirements of exotic beam facilities. At the same time highly-efficient detector systems have been built and accelerator techniques, i.e. transmission capabilities, upgraded. These developments applied to a new generation stable-beam facility open new possibilities to conduct gamma spectroscopy studies of super heavy elements using Coulomb excitation. Secondary beam production of unstable heavy elements requires the use of a new recoil mass separator. Two possible types of such separators could be considered: the gas filled one (e.g. as discussed by D. Seweryniak in chapter 4.3) or the vacuum type. However, in contrast to the existing devices, a new separator which could be used to produce super heavy nuclei studied further with Coulomb excitation would have to operate in the inverse kinematics mode.

References:

- [1] http://slcj.uw.edu.pl/wp-content/uploads/2020/07/Cline_talk_slides_Poznan2013_Smoluchowski-medal.pdf
- [2] http://slcj.uw.edu.pl/wp-content/uploads/2018/08/Gosia_Manual_20120510.pdf
- [3] D. Cline Ann. Rev. Nucl. Part. Sci 36 ,683 (1986).
- [4] K. Wrzosek et al. , Phys. Rev. C86, 064305(2012).

Chapter 7

From isomers to giant resonances

Conveners:

J. Dudek

UdS/IN2P3/CNRS, Strasbourg, France and UMCS, Lublin, Poland
and

B. Fornal

The H. Niewodniczański Institute of Nuclear Physics PAN, Kraków, Poland

The proposal to construct a new accelerator for the Heavy Ion Laboratory with new possibilities in terms of available beams and their qualities, encourages a discussion of the perspectives for new areas of research and new formats of international collaboration, together with the scientific position of Poland in the related domains of subatomic physics. In this chapter we focus on the research perspectives which provide powerful tools to study challenging nuclear structure phenomena such as new symmetries and new transition-hindrance mechanisms, nuclear Jacobi and Poincare transitions and new nuclear phases and phase transitions, unprecedented extreme shape deformation domains at high spins and varying temperatures and, last but not least, a broad range of nuclear structure studies from ‘traditional’ to exotic to very exotic nuclei.

Let us begin by noting certain common elements between the physics of isomers, which may appear at various, and in particular high excitation energies, and the physics of the Giant Resonances. In fact, for a nuclear structure physicist research in the above two domains involves broadly discussed links with the subject of nuclear symmetries, spontaneous symmetry breaking, nuclear phase transitions, critical points and critical phenomena, cf. the most recent dedicated conferences [1].

Indeed, the isomers addressed in the present discussion can be grouped into three families: (i) the well-known K-isomers, which appear in axially symmetric nuclei, both prolate and oblate; (ii) the shape isomers arising from the existence of secondary minima in the nuclear potential energy surface (PES); and, (iii) the isomers generated by the so-called high-rank symmetries, tetrahedral and octahedral, which represent a new class of phenomena of interest. The latter gain particularly in actuality in view of the recent experimental findings [2].

The K-isomers, whose existence depends on a large change in K accompanying their decay, the projection of the total angular momentum on the symmetry axis, provoke several challenges related to the presence of tri-axial degrees of freedom and the resulting K-mixing. Recently, the physics of K-isomers became of interest in the context of super-heavy nuclei (SHN). It is well known that SHN in their ground states are unstable systems with extremely low production cross sections. However, it has been conjectured that the K-isomerism phenomenon may provide enhanced stability for these species. The line of research which aims at a systematic search for new, long-lived K-isomers in heavy nuclei, guided by the newly developed models, would be of great importance for predicting the existence of these long-lived metastable states in SHN and subsequent identification measurements. Such studies necessarily involve lifetime measurements which use

the electromagnetic radiation from de-exciting isomers. This implies the necessity of preparing the corresponding equipment, i.e., a germanium γ -ray array coupled to a magnetic spectrometer or separator for the reaction products.

The phenomenon of nuclear shape isomerism arises from the existence of secondary minima in the nuclear PES, separated from the primary energy minimum (the ground state) by sufficiently high potential energy barriers, which hinder or slow down the transitions between the minima.

It is natural to expect K-isomerism in the axial-symmetry secondary PES minima, because the super-deformed axially symmetric shape imposes the conservation of the K quantum number. In fact, candidates for K-isomers in the secondary well of some of the actinides were tentatively identified in previous studies. Such K-isomers could serve as a highly promising testing ground for the nuclear models. Since this issue is largely unexplored, the availability of intense heavy-ion beams at a Polish laboratory, together with the possibilities of using radioactive actinide targets, would open an exciting opportunity for high-K fission isomer studies.

The physics of high-rank symmetry isomers imposes alternative detection methods given the fact that the isomers in question essentially do not involve electromagnetic radiation, either in terms of population or in terms of de-excitation. The corresponding instrumentation would involve high-resolution mass spectrometry tools. An existing example is provided by the FRS spectrometer at GSI, Darmstadt, Germany, where the first research of the tetrahedral and octahedral symmetry induced shape isomers has begun.

The highly excited states populated within the Giant Dipole Resonance (GDR) mechanism and the induced nuclear Jacobi and Poincare shape transitions involve a simultaneous variation of the nuclear temperature and angular momentum. Such hot rotating nuclei manifest forms of behavior analogous to those known in the physics of astronomical objects under the names of Jacobi and Poincare transitions. Both types of transition can be seen as shape transitions induced by increasing nuclear angular momentum. Such an increase leads first to an increase of the oblate deformation, whereas the angular momentum remains aligned with the nuclear symmetry axis. At a certain critical value of angular momentum, the system loses stability against axial geometrical forms, the nucleus becomes non-axial and quickly elongates with a further increase of spin. The Poincare transitions correspond to a further loss of stability, this time against the left-right asymmetry, which may take place in certain nuclear ranges. Both types of transitions lead to shape-phase transitions [1].

As it turns out, in the vicinity of the critical spin values, the nuclear shapes change dramatically being accompanied by rapid changes in the occupancy of the underlying single particle orbitals for negligible changes in the potential energy, typically of the order of a couple of hundreds of keV, the properties associated with critical phenomena. At the same time, one finds special singular states or sequences of states (e.g., super-deformed bands) at zero temperature coexisting with / embedded among the huge density of states just mentioned – another exotic mechanism worth investigating in our future plans.

The importance of studies of giant dipole resonances in the present context consists in the fact that the profile of the GDR radiation distribution function allows us to determine experimentally the most probable nuclear shapes, including non-axial shapes, cf. Ref. [3] for the first manifestation of the so-called Coriolis splitting of the giant-dipole resonance.

These measurements provide important by-product information: the population probability distributions indicating the most likely deformation fed. With this, and only with this information one will be able to address the physics of nuclear hyper-deformed configurations whose mechanism still remains elusive.

Thus, investing in studies of giant-dipole resonance population and decay properties, especially in connection with Jacobi shape transitions, involves the issue of the population and detection of super- and hyper-deformed bands. Instrumental needs for such studies would involve multi-detector systems (calorimeter type or Germanium arrays), and the possibility of inviting the PARIS and/or AGATA collaborations to place their detection systems in conjunction with a future accelerator of appropriate parameters would certainly offer unique opportunities.

In the table below, accelerated light- and heavy-ion beams, as well as detection systems required for the specific projects related to isomer and giant resonance studies are briefly summarized. The acronym “nHIL” represents the new high intensity cyclotron considered for installation at HIL.

Subject	Beams/Targets	Facility	Required Detection systems & other Instrumentation <i>existing / new</i>
Search for high-K isomers in heavy neutron-rich nuclei	28<Z<92	nHIL	EAGLE or AGATA Ge array, conversion-electron spectrometer, <i>heavy-ion magnetic spectrometer</i>
K isomers in secondary minima	High intensity beams 6<Z<82; radioactive actinide targets ^{226}Ra , $^{230,232}\text{Th}$, $^{232-238}\text{U}$, $^{238-242}\text{Pu}$	nHIL	EAGLE or AGATA Ge array, conversion-electron spectrometer, <i>gas-filled magnetic separator</i>
Search for high-rank symmetry isomers	High-intensity beams 6<Z<82	nHIL	<i>high-resolution magnetic spectrometer</i>
K-isomers in fission products	p (70-230 MeV) actinide targets ^{232}Th , ^{238}U	CCB	<i>compact Ge array, gas-filled separator, beta-decay station</i>
GDR in super-heavy nuclei	6<Z<40	nHIL	large acceptance reaction products detector (FAZIA), PARIS
GQR, GDR built on low-lying excited states	p (70-230 MeV)	CCB	KRATTA HECTOR, LaBr ₃ array, PARIS <i>High-resolution magnetic spectrometer</i>
Search for hyper-deformation	heavy-ion beams	nHIL	AGATA+PARIS+RFD

A collection of short reports from the presentations given in the session “From isomers to giant resonances” is presented below. They cover the issues related to studies of high-rank symmetry isomers, K-isomers, shape isomers and high-K shape isomers, as well as “stretched state” resonances, pigmy dipole resonances and giant dipole resonances which probe nuclear phenomena at high spin and high temperature.

References:

- [1] 9th International Conference on Quantum Phase Transitions in Nuclei and Many-Body Systems, Padua, 2018
- 8th International Conference on Quantum Phase Transitions in Nuclei and Many-Body Systems, Prague, 2016
- 7th Conference on Shape-Phase Transitions and Critical-Point Phenomena in Nuclei, Seville, 2014
- [2] J. Dudek *et al.*, Phys. Rev. C **97**, 021302(R) (2018)
- [3] A. Maj *et al.*, Nucl. Phys. A **731**, 319 (2004), especially Fig. 4.

7.1 High-spin state nuclear phenomena

J. Dudek

UdS/IN2P3/CNRS, Strasbourg, France and UMCS, Lublin, Poland

The nuclear phenomena accompanying the variation of the angular momentum of the system are strongly related to the very intuitive notion of shape changes and evolution. The notion of the nuclear shape in turn is justified via very powerful nuclear mean field theory thanks to the very short range of the nuclear interactions. These concepts gave rise to the mechanism of nuclear shape vibrations and rotations together with the description of the large amplitude motion and corresponding theories, which gave rise to the Nobel Prize for A. Bohr, B. Mottelson and L. Rainwater. The related effects combine with the effects of the pairing correlations, which lead to the mechanism of nuclear superfluidity present in the majority of atomic nuclei and manifested via the effective moment of inertia values roughly at the level of 50% of the corresponding rigid-body value.

The ensemble of phenomena referred to as the physics of nuclear high spin is rich in terms of mechanisms and structures such as various rotational bands with their crossings and interactions, the pairing phase transition, angular momentum alignment and associated blocking phenomena and back-bending, the rotation-induced extreme nuclear elongations referred to as super-deformed and hyper-deformed configurations, and many other effects related to the feeding and decay of the nuclear configurations involved.

The description and discussion of so-called high-spin behavior usually includes the low-, and moderate spin regimes, which define the reference zones for the follow-up at the highest limits involving nuclear fission induced by the high-spin rotation. In particular, it is by examining this intermediate spin zone that we may learn in the most direct way about the single-nucleon spectra and their evolution in terms of collective rotation and nuclear deformation. The corresponding information is usually obtained by combining modelling in terms of realistic nuclear mean-field calculations and analysis of the back bending and the blocking of the back bending by an odd particle placed on the appropriate nucleonic level. It is worth emphasizing that this technique is among the most powerful for providing information about the deformed mean-field nucleonic orbitals for the ensemble of the nuclear structure.

High spin physics is very strongly related to exotic shape coexistence involving the highly elongated nuclear configurations referred to as super- and hyper-deformed. These structures arise as manifestations of the nuclear symmetry referred to as pseudo-SU(3) symmetry. Whereas the former have been established in many nuclei, the latter remained elusive, mainly due to the fact that population mechanisms were recognized only recently in the context of the Jacobi transitions. Studying the properties of these exotic configurations will bring at the same time information about the mean-field nuclear properties related to the single-nucleonic orbitals as well as the collective properties, pairing phase transitions and their differences in various fast-spinning nuclear configurations as well as the stability of the most elongated configurations bringing microscopic information about nuclear fission from the excited configurations.

7.2 Isomers in Exotic Nuclei

I. Dedes

Institute of Physics, Maria Curie-Skłodowska University, Lublin, Poland

Studying exotic nuclei is of primary interest in nuclear physics today. It is attracting more and more attention with increasing improvements of the population and detection capabilities of existing experimental facilities. Present-day problems arise when the instrumental detection capacities of short-lived nuclear species are insufficient to produce an identifying signal. Under such circumstances an extremely attractive idea consists in focusing research on nuclei with very exotic Z and N combinations on the excited isomeric states, which may live longer or much longer than the corresponding short-lived ground states.

From the physics point of view, it is of great importance to examine the possible presence of certain specific symmetries predicted to occur in certain (and in particular) exotic nuclei. Such symmetries are expected to generate hindrance factors in the context of various electromagnetic transitions, thus bringing the possibility of very long-lived nuclear states. The symmetries at the top of the list today are the tetrahedral and octahedral, the so-called high-rank symmetries, whose experimental identification was recently announced in Ref. [1]. These symmetries are extremely attractive from various points of view, in particular because of the four-fold degeneracies - in contrast to the 'usual' Kramers (double) degeneracies - of certain nucleonic levels, thus leading to 16-, and 32-fold degeneracies in terms of particle-hole and two particle - two-hole excitations. But in the present context the most attractive feature related to the high-rank symmetries consists in the fact that they produce neither collective E1 nor E2 transitions in their rotational bands. Thus, the new search criterion would be to detect the isomeric states related to rotational bands - therefore with energies satisfying the usual parabolic energy-spin relation, $E(I) \sim I(I+1)$ - but with no E2 transitions. One of the measurement approaches adapted to this case would be to use modern mass spectrometry methods. This offers a very attractive possibility of focusing studies of exotic nuclei on new areas of the Periodic Table where the ground states live too shortly to be detectable with present-day instrumentation while the high-rank symmetry minima provide long-lived traps to catch the nuclei in question.

In a recent article [1] the first experimental evidence of the nuclear tetrahedral and octahedral symmetries was presented and the spectroscopic criteria of identification of these new symmetries were developed. This, we believe, opens totally new perspectives

for both exotic-nuclei and exotic-symmetry studies, wherefrom the term “new era in nuclear spectroscopy”.

Another class of isomers imposed by symmetry whose presence in excited spectra can be used to identify the underlying nuclear configurations, is composed of the so-called K-isomeric configurations. There the hindrance is provided by the fact that the corresponding nuclei have an axial symmetry – yet with the nuclear spin aligned with the symmetry axis which implies that collective rotation is impossible. The energy vs. spin relation turns out to be in general very irregular leading to “energy pockets” traditionally referred to as yrast traps. Such configurations provide another chance to identify otherwise too short-lived nuclei.

References:

[1] J. Dudek *et al.*, Phys. Rev. C **97**, 021302(R) (2018).

7.3 K shape isomers in the secondary potential well of heavy nuclei – experimental perspectives

B. Fornal

The H. Niewodniczański Institute of Nuclear Physics PAN, Kraków, Poland

In collaboration with:

S. Leoni et al., University of Milan and INFN Sezione di Milano, Milan, Italy

N. Marginean et al., IFIN-HH Bucharest, Romania

The existence of secondary minima in the nuclear potential energy surface (PES), separated from the primary energy minimum (the ground state) by a high potential energy barrier, may give rise to shape isomerism: the barrier may hinder transitions between states located in different minima. Shape isomers at spin zero, i.e., states with $J^\pi=0^+$ located in the secondary minima, whose decay is highly hindered, have so far been clearly observed exclusively in actinide nuclei [1,2]. In other species, where the transitions hindered due to shape change have been identified (for example, in the Ni and Cd isotopes [3-5]), this hindrance is not large.

In turn, K-isomers, where K is the projection of the total angular momentum on the symmetry axis, result from a large change in K during the decay.

Considering that the super-deformed axially symmetric shape, which the nucleus takes in the secondary PES minimum, provides an excellent condition for the conservation of the K quantum number, it is natural to expect the presence of K-isomers in this minimum – let us call them K shape isomers. Such isomers could serve as a testing ground for models which foresee the occurrence of long-lived metastable states in super-heavy nuclei.

Candidates for K shape isomers were tentatively identified in earlier studies in the secondary well of some of the actinides [6]. However, as those states were seen through their fission, the experimental evidence is limited and includes only half-lives and approximate excitation energies - the spins and parities have not been determined due to the lack of observation of γ -ray transitions to known states.

To extend our knowledge of K shape isomers we have to find cases where the decay of these states proceeds via γ -ray emission. It is very likely that in nuclei with γ -decaying

shape isomers, K shape isomers will also decay via γ emission [6,7] - this is schematically illustrated in the right-hand side of Figure 1. In Fig.1 (left-hand side), the actinide nuclei in which γ -decaying shape isomers have been identified (solid red squares) or predicted (solid red circles) are shown. They are candidates for the existence of γ -decaying super-deformed K shape isomers. It is proposed here to search for such structures by using one- or two-nucleon sub-barrier transfer reactions induced by very heavy beams on rare actinide targets (possible targets are displayed in the figure as half circles). The excited heavy target-like products, after exiting from the target, would be separated with a gas-filled magnetic separator, deposited in the focal plane and studied with a small germanium array.

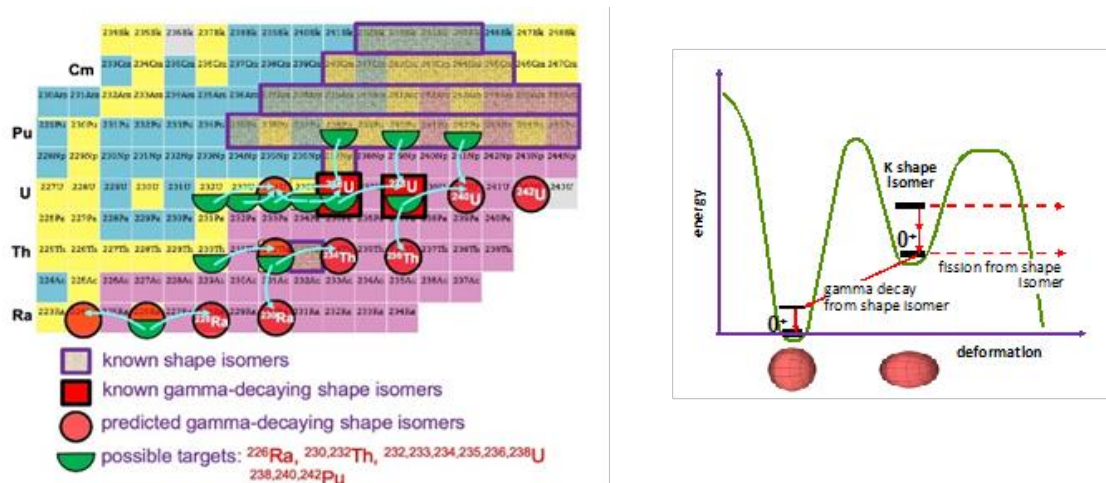

Fig.1 Map (left) of actinide nuclei in which γ -decaying shape isomers were identified (solid red squares) or predicted (solid red circles) are shown. Possible targets for studies using one- or two-nucleon sub-barrier transfer reactions induced by very heavy beams are displayed as half circles. The right-hand side shows a schematic illustration of a K-shape-isomer decay

Because the issue is largely unexplored, the availability of intense heavy-ion beams at a Polish laboratory, together with the possibility of using radioactive actinide targets, would open an unprecedented opportunity for K shape isomer studies.

References:

- [1] S. M. Polikanov, Sov. Phys. Uspekhi **15**, 486 (1973).
- [2] B. Singh, R. Zywna, and R. Firestone, Nucl. Data Sheet **97**, 241 (2002).
- [3] S. Leoni, B. Fornal *et al.*, Phys. Rev. Lett. **118**, 162502 (2017).
- [4] N. Marginean *et al.*, Phys. Rev. Lett. **125**, 102502 (2020).
- [5] P. E. Garrett *et al.*, Phys. Rev. Lett. **123**, 142502 (2019).
- [6] H. L. Liu *et al.*, Eur. Phys. J. A **47**, 135 (2011).
- [7] S. Bjørnholm, J.E. Lynn, Rev. Mod. Phys. **52**, 725 (1980).

7.4 PARIS – status, perspectives for installation in Poland and studies of hot rotating nuclei

M. Ciemala¹, A. Maj¹, P. Bednarczyk¹, M. Kmiecik¹, B. Fornal¹, B. Wasilewska¹,
M. Krzysiek¹, P. Napiorkowski², M. Kicińska-Habior² *et al.*

¹ *Institute of Nuclear Physics Polish Academy of Sciences, Kraków, Poland*

² *Heavy Ion Laboratory, University of Warsaw, Poland*

PARIS is a large array of phoswich detectors expected to measure γ rays over a wide range of energy from a few hundred keV to 40 MeV. It is envisaged to serve the dual purpose of a high-energy γ -ray spectrometer and a spin-spectrometer, capable of determining the multiplicity of low energy (100 keV to a few MeV) discrete γ rays associated with a specific reaction. Upon completion PARIS is envisaged to be an array of 216 phoswich detectors. The front section of each phoswich detector is a cubic (2x2x2) LaBr₃ or CeBr₃ crystal optically coupled to a 6" long square bar of NaI(Tl) of matching cross section. Each of these detectors is to be read by a single photomultiplier tube (PMT) of 2" diameter that would allow close packing of such detectors. It is planned to combine 9 phoswich detectors in a square (3x3) close packed geometry forming a single cluster [1-4] (Fig.2). Thanks to the use of LaBr₃-NaI and CeBr₃-NaI phoswiches, the cluster is characterized by good energy and timing resolution and appreciably high efficiency, especially for high energy γ rays. Due to these properties it can be used to measure both γ rays emitted in the decay of Giant Resonances and discrete γ transitions. Moreover, the granularity of PARIS makes possible its use as a multiplicity filter.

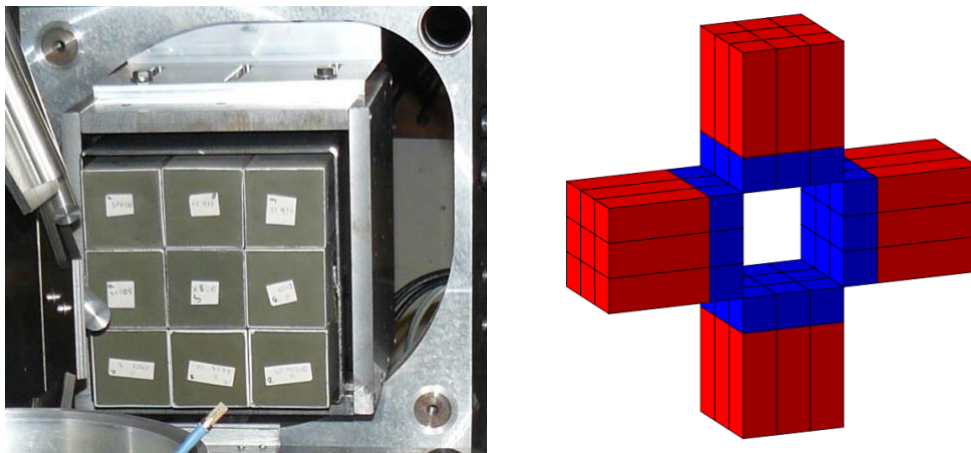

Fig.2 Left: PARIS, 9 phoswiches in cluster configuration - photo taken during preparation of an experiment at GANIL, Caen, France. Right: Schematic view of the possible arrangement of 4 PARIS clusters.

PARIS is well suited to perform experiments on hot and rotating nuclei. In particular, it could be employed in this kind of measurement at the Heavy Ion Laboratory (HIL), with beams provided by the new cyclotron. Selected PARIS related physics cases which could be possible at HIL are:

- **Measurements of Pre-fission Giant Dipole Resonances (GDR) in super-heavy isotopes.**

Production of super-heavy nuclei, which relies on the formation of an equilibrated compound system, is strongly suppressed because a short-lived non-equilibrated composite system, formed after a heavy-ion collision, in most cases fissions before reaching

equilibrium. In previous experimental studies [5, 6] it was shown that it is possible to observe the IVGDR in such excited non-equilibrated systems. The main difficulty in this kind of experiment is to disentangle γ rays coming from the decay of the IVGDR in the hot composite system from those emitted in the decay of excited fragments created by fission. This problem can be overcome by performing measurements at different excitation energies as shown in Fig.3. Here, E_1 and E_2 are excitation energies of the composite product formed in two reactions at different beam energies, while E_f is the energy at which fission occurs. If $E_1 > E_2 > E_f$ (slow fission compared to γ emission), the difference between the post-fission γ -ray spectra associated with the two reactions should be small, while the pre-fission difference should be visible. If fission occurs very fast ($E_f > E_2 > E_1$), the differential γ -ray spectrum is dominated by emissions from fission fragments. Therefore, the measured spectra of γ rays emitted from a complex system formed at the excitation energy E_1 and E_2 ($E_1 > E_2$) allow the extraction of the time scale of the fission process for super-heavy nuclei, and make it possible to determine their deformations at high temperature.

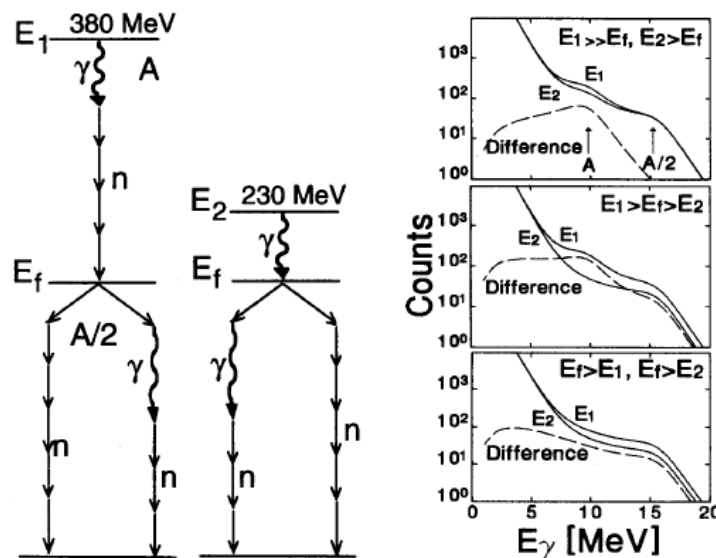

Fig.3 Left: schematic illustration of the differential method to measure GDR γ decay. Right: the three scenarios for the difference γ -ray yield. [Figure taken from Ref. 5].

For the study discussed above, the new Warsaw cyclotron will be very well suited, as it will deliver intense $A \approx 50$ beams which can be used to form super-heavy complex systems. High energy gamma rays from GDR decay will be measured with the PARIS detectors, and fission fragments will be detected by a suitable heavy charged particle detector such as FAZIA [7].

- **Nuclear deformation evolution as a function of temperature and angular momentum**

The properties of the GDR have been studied for years as a function of temperature and angular momentum, providing information on many nuclear characteristics. Among these are single particle state evolution, effective shapes of hot nuclei with temperature and spin, the damping mechanism, and isospin mixing. In particular, the GDR is a good tool for studies of nuclei under extreme conditions, at high temperature or angular momentum. A very interesting feature of nuclei is the Jacobi shape transition, which is predicted to occur in the high angular momentum region [8, 9]. This phenomenon is an abrupt change of the nucleus shape from oblate, through triaxial, and then to more and more elongated

shapes up to nuclear fission. The Jacobi shape region corresponds to the highest possible deformation of the nucleus before it fissions. So far, this phenomenon was observed only in the $A \sim 40$ mass region [10, 11, 12]. Another region, where very extreme spins can be reached, is $90 < A < 140$, as here the limiting angular momentum for the fission process is very high.

With the Warsaw cyclotron facility, it is possible to investigate the shape evolution of hot nuclei in the $A \sim 100$ and $A \sim 130$ mass regions, at extreme angular momenta, by the measurement of high-energy gamma rays from the GDR decay (PARIS array) in coincidence with light charged particles and residual nuclei (for example FAZIA).

- **Studies of the properties of the GDR built on high-spin isomeric states.**

The GDR has been proven to constitute a very good tool for nuclear shape studies [13]. It is known that the properties, such as deformation, of a nuclear state on which the GDR is built, are reflected by the GDR strength function. This was observed by studying the decay of the GDR excited in hot compound nuclei to the ground states [14, 15, 16] and high-spin isomeric states in the final products [17, 18].

With the help of the PARIS array coupled to a highly efficient HPGe array, such as AGATA [19] or EAGLE [20], the link between the deformation of the hot nucleus and various deformations of the final state of the residue can be investigated. The GDR built on states of certain deformation will be studied measuring high-energy γ rays in coincidence with low spin discrete transitions. The high energy γ rays from the GDR decay will be measured using PARIS clusters. They will provide information on the compound nucleus properties, particularly on the GDR effective shape. Discrete transitions in the evaporation residues, simultaneously measured with the AGATA/EAGLE array, will enable the selection of final products of specific deformations. As a result, the GDR strength functions measured at particular decay paths will be obtained, giving information on the behavior of the nuclear deformation. The experimental data will also deliver information on feeding of low energy structures by the high energy γ rays from the GDR decay. This result will be obtained from the intensity of low energy transitions gated on GDR energy intervals.

- **Study of isospin mixing with GDR**

Isospin symmetry is largely preserved by the nuclear interaction; however, it is broken by the Coulomb interaction. The degree of mixing, quantified by the observable α^2 (mixing probability), can be measured by using selection rules for nuclear decays, which forbid transitions between nuclear states of different isospin. For the E1 transitions, the best mechanism to consider is the GDR [21, 22, 23], where the E1 strength is concentrated, and thus ideal to search for small effects in the breaking of this selection rule. This approach can be exploited to measure the α^2 value at finite temperature and to extract its zero-temperature value, considering that a model [24] was developed in the framework of which the value of the isospin mixing at zero temperature can be connected to that at finite temperature.

To extract the zero-temperature value of the isospin mixing, at least two measurements for the same system at different temperatures are required - up to now this has been done only for the ^{80}Zr nucleus [25]. By employing the technique mentioned above at the Warsaw cyclotron it will be possible to measure isospin mixing in lighter $N=Z$ nuclei also. In this case, the use of the PARIS array (GDR γ decay) coupled to the charged particle and evaporation residue detector (FAZIA) will be crucial.

References:

- [1] A. Maj *et al.*, *Acta Phys. Pol. B* **40**, 565 (2009).
- [2] M. Ziębliński *et al.*, *Acta Phys. Pol. B* **44**, 651 (2013).
- [3] B. Wasilewska *et al.* in: O. Roberts, L. Hanlon, S. McBreen (Eds.), *Applications of Novel Scintillators for Research and Industry*, IoP Publishing Ltd, Bristol (2015).
- [4] C. Gosh *et al.*, *JINST* **11**, P05023 (2016).
- [5] A. Maj *et al.*, *Acta Phys. Pol. B*, **26** (1995).
- [6] T. S. Tveter, J. J. Gaardhoje, A. Maj *et al.*, *Phys. Rev. Lett.* **76** (1996).
- [7] R. Bougault *et al.*, *Eur. Phys. J. A* **50**, 47 (2014).
- [8] K. Pomorski and J. Dudek, *Phys. Rev. C* **67**, 044316 (2003).
- [9] K. Mazurek, J. Dudek, A. Maj, and D. Rouvel, *Phys. Rev. C* **91**, 034301 (2015).
- [10] A. Maj *et al.*, *Nucl. Phys. A* **731**, 319 (2004).
- [11] M. Kmiecik *et al.*, *Acta Phys. Pol. B* **36**, 1169 (2005).
- [12] D. Pandit *et al.*, *Phys. Rev. C* **81**, 061302(R) (2010).
- [13] P. Bortignon, A. Bracco, and R. A. Broglia, *Giant Resonances: Nuclear Structure at Finite Temperature* (Gordon & Breach, New York, 1998)
- [14] F. Camera *et al.*, *Phys. Rev. C* **60**, 014306 (1999).
- [15] M. Kmiecik *et al.*, *Nucl. Phys. A* **674**, 29 (2000).
- [16] M. Kmiecik *et al.*, *Eur. Phys. J. A* **12**, 5 (2001).
- [17] M. Kmiecik *et al.*, *Phys. Rev. C* **70**, 064317 (2004).
- [18] J.P.S. van Schagen *et al.*, *Nucl. Phys. A* **581**, 145 (1995).
- [19] S. Akkoyun *et al.*, *Nucl. Phys. A* **668**, 26 (2012).
- [20] J. Mierzejewski *et al.*, *Nucl. Instrum. Methods* **659** (2011) 84.
- [21] M. Harakeh *et al.*, *Phys. Lett. B* **176** (1986).
- [22] J.A. Behr *et al.*, *Phys. Rev. Lett.* **70** (1993).
- [23] M. Kicińska-Habior *et al.*, *Nucl. Phys. A* **731c**, 138 (2004).
- [24] H. Sagawa *et al.*, *Phys. Lett. B* **444**, 1 (1998).
- [25] S. Cerutti *et al.*, *Phys. Rev. Lett.* **115**, 222502 (2015).

7.5 Giant Resonances built on cold nuclei

B. Wasilewska, M. Kmiecik, M. Ciemała, A. Maj, J. Grębosz, J. Łukasik, P. Pawłowski,
B. Sowicki, M. Ziębliński *et al.*

The H. Niewodniczański Institute of Nuclear Physics PAN, Kraków, Poland

*M. Kicińska-Habior, P. Napiorkowski *et al.**

Heavy Ion Laboratory, University of Warsaw, Warsaw, Poland

Giant Resonances are high-energy collective states of the nucleus, characterized by a large excitation cross section. Numerous studies are focused on the Giant Dipole Resonance (GDR) and excited states known as the Pygmy Dipole Resonance (PDR). These two modes are responsible, over a wide range of γ -ray energies, for the shape of the γ -ray strength function (γ SF), whose proper parameterization is crucial for a successful description of the r-process in nucleosynthesis. In recent years, more and more interest has been devoted to the Giant Quadrupole Resonance as well, the observation of whose γ -ray decay has been reported only once so far.

The advent of highly efficient arrays for γ -ray energy measurement, used in coincidence with detectors for scattered beam ions, has given rise to the hope of conducting systematic studies of the γ decay of this excitation. Such coincidence measurements can also be used to test the generalized Brink-Axel hypothesis stating that γ SF is independent of the energy and spin of the state on which it is built.

In recent years an experimental set-up to study Giant Resonances has been built in Krakow, Poland at the Cyclotron Centre Bronowice (CCB) [1] and a pilot experiment using the $^{208}\text{Pb}(p,p'\gamma)$ reaction has been performed [2]. In this experiment various excitation modes including PDR and GDR have been observed, as well as their γ decay. The results obtained show the experimental sensitivity to different modes of de-excitation (see Fig.4), confirming the possibility to run a world-class experiment at this facility. The continuation of this experiment is already accepted by the International Advisory Committee.

It is well known that various probes populate excited states with various probabilities [3]. The alpha inelastic scattering reaction is particularly recognized as the best possible probe for the excitation of isoscalar modes. Unfortunately, an alpha beam is not available at CCB. A common research program based at CCB Krakow and the Heavy Ion Laboratory (HIL), where an alpha beam can be provided, would allow complementary data to be obtained, giving better insight into the Giant Resonance phenomenon.

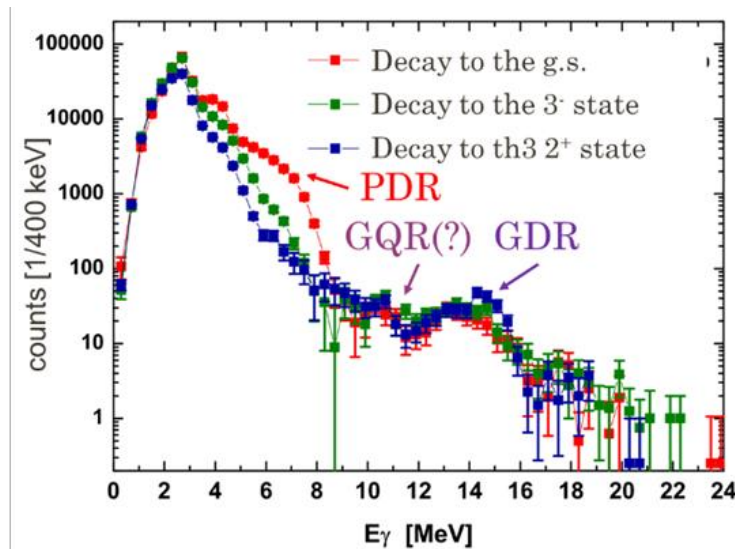

Fig.4 γ energy spectra corresponding to the decay of the excitation of various states in ^{208}Pb

The program could consist of: first, establishing a dedicated set-up for $(\alpha, \alpha'\gamma)$ reaction measurements at HIL, confirmation of the observation of ISGQR γ decay in ^{208}Pb , systematic studies of ISGQR γ decay in other nuclei (e.g. ^{90}Zr , ^{124}Sn). As the theoretical predictions show, the ISGQR shape should be sensitive to the nuclear deformation. By studying an isotopic chain, for example Sn or Nd isotopes, this prediction could be tested.

To make the studies successful, a few upgrades of the facilities would be needed. The energy and time resolution of the alpha beam should be improved, and the beam energy should be boosted to around 20 MeV/u, at least. This would also benefit from the installation of a high-resolution spectrometer, which would allow the measurement of the energy of the inelastically scattered particles with high precision. This way a cutting-edge, world-class experimental program could be conducted at two Polish laboratories.

References:

- [1] B. Wasilewska *et al.*, Acta Phys. Pol B **48**, 415 (2017).
- [2] B. Wasilewska *et al.*, Acta Phys. Pol B **50**, 469 (2019).
- [3] A. Bracco, E.G. Lanza and A. Tamii, Prog. Part. Nucl. Phys. **106**, 360 (2019).
- [4] M. N. Harakeh and A. van der Woude. *Giant Resonances*. Oxford University Press (2001).

7.6 Experimental studies of the strength function below the binding energy

M. Krzysiek¹, A. Maj¹, P. Bednarczyk¹, M. Ciemala¹, B. Fornal¹, M. Kmiecik¹,
P. Napiorkowski², B. Wasilewska¹ *et al.*

¹ *The H. Niewodniczański Institute of Nuclear Physics PAN, Kraków, Poland*

² *Heavy Ion Laboratory, University of Warsaw, Warsaw, Poland*

Most of the electric dipole (E1) response of the atomic nucleus is exhausted by the Isovector Giant Dipole Resonance (IVGDR). However, below the IVGDR and around the neutron separation energy, a small fraction of fragmented dipole states is also observed. These excitations, called Pygmy Dipole Resonances (PDR), were interpreted as a collective oscillation of a number of neutrons at the nuclear surface against the inert proton-neutron core. However, this rather intuitive model is still under theoretical evaluation and further experimental data are of the utmost importance. One of the key questions is whether the PDR has a collective or single-particle nature. Moreover, it was shown in (γ , γ') and (α , $\alpha'\gamma$) experiments [1] that low-lying E1 states have mixed isospin properties. While the photon probe excites all states, alpha particles are only sensitive to the isoscalar part.

For future experiments using the proton cyclotron at CCB IFJ PAN in Krakow and a new heavy-ion cyclotron at the Heavy Ion Laboratory in Warsaw, we consider using γ -particle coincidence measurements to study the γ decay of the PDR. We propose systematic studies of selected isotopic chains of stable isotopes, e.g., calcium. We propose employing two different types of reactions:

Inelastic scattering

This has been shown to be a perfect tool to excite low-spin states around the neutron threshold [2,3]. Depending on the applied probe, one can study the isospin properties of the PDR: (i) protons - excitation mechanism similar to photons close to 0° scattering angle; (ii) alpha particles or ^{17}O - isoscalar nature, more surface interactions.

One-neutron transfer (e.g., deuterons, ^7Li or ^{13}C)

This type of reaction favors excitation of single-particle transitions. This would provide the experimental information on collectivity of PDR states, information on which is very limited.

In order to perform γ -particle coincidence measurements one requires high-energy resolution and high detection efficiency for both γ and particle detection. Furthermore, in order to perform a precise Doppler correction and be sensitive only to dipole excitations, position sensitivity of detection system should be as good as possible.

γ -ray detection

A natural choice for discrete γ spectroscopy is provided by HPGe detectors which have the best energy resolution. The perfect solution would be to use the AGATA array [4] to profit from its excellent position sensitivity and efficiency. In order to increase the efficiency of γ - γ coincidence measurements, one may consider the use of the scintillation detectors of the PARIS array [5]. This would allow the determination of the branching of the PDR decay to ground and low-lying states.

Particle detection

A satisfactory approach would be to use segmented ΔE - E silicon telescopes. They have good energy resolution and reasonable position sensitivity of $\sim 3^\circ$. They are modular and provide quite large angular coverage. However, they have several limitations, e.g., sensitivity to radiation damage, which does not permit measurements at small forward angles. This could be overcome with a magnetic spectrometer, which furthermore provides excellent energy resolution, important to estimate precisely the excitation energy.

References:

- [1] D. Savran *et al.*, Phys. Rev. Lett. **97**, 172502, (2006).
- [2] A. Bracco, F. C. L. Crespi, and E. G. Lanza, Eur. Phys. J. A **51**, 99 (2015).
- [3] M. Krzysiek *et al.*, Phys. Rev. C **93** 044330, (2016).
- [4] S. Akkoyun *et al.*, Nucl. Instr. And Meth. A **668**, 26 (2012).
- [5] A. Maj *et al.*, Acta Phys. Pol. B **40**, 565 (2009).

7.7 Decay of “stretched” states in the continuum

N. Cieplicka-Oryńczak, B. Fornal, M. Kmiecik, A. Maj, M. Ciemala, B. Wasilewska, M. Krzysiek, Ł. W. Iskra, M. Ziębliński, J. Łukasik, P. Pawłowski *et al.*

The H. Niewodniczański Institute of Nuclear Physics PAN, Kraków, Poland

S. Leoni, A. Bracco, G. Benzoni, S. Brambilla, C. Boiano, F. Camera, F. Crespi *et al.*

University of Milan and INFN Sezione di Milano, Milan, Italy

The “stretched” states are nuclear excitations arising from the promotion of one particle across the shell gap which possess the highest possible spin such a configuration offers – they are one of the simplest excitations in the continuum. The properties of stretched states are poorly known, even though they are of key importance for the physics of unbound systems. In light nuclei, stretched excitations appear as high-lying (in energy) resonances and direct measurement of their decay should provide data which can be used as a very demanding test of state-of-the-art theoretical approaches, from the Shell Model in the Continuum to the *ab-initio* type, shedding light on details of the nuclear interactions as well.

Here, we focus on an investigation of the decay of the so-called M4 stretched state located at 21.47 MeV in ^{13}C . Information on the decay of M4 resonances in light nuclei will be obtained by measuring inelastically scattered protons (which excite the resonance) in coincidence with charged particles from the decay of the resonance, and γ rays from the daughter nuclei. In particular, the emitted γ rays will give precise knowledge on the decay to specific states, even in the case of neutron emission from the resonance. Measurements will be made by employing inelastic scattering of a proton beam from the PROTEUS-235 cyclotron at the Cyclotron Centre Bronowice (CCB) in Kraków from a ^{13}C target, and detecting the emitted γ rays and light charged particles. The detection setup presently available at CCB consists of: i) a thick position-sensitive Si detector, ii) an array of LaBr₃ detectors (3”x3”), iii) two clusters of the PARIS scintillator array, and iv) the KRATTA telescope array. The experimental results will be compared with theoretical calculations based on the Gamow Shell Model approach, provided by the theory group at IFJ PAN in Krakow.

Future possible developments of the experimental equipment at the CCB facility in Kraków can be considered – they could be realized by: (i) construction of a new experimental hall

and installation of a magnetic spectrometer, and (ii) completing the presently available setup by installing a HPGe for scattered proton energy measurements. As the precise determination of the excitation energy of the resonance induced by inelastic proton scattering could be obtained with such devices, investigations of states in the continuum would be accessible in a very broad range of nuclei and their excitation energies. This would allow the proposed research to be extended to other nuclear systems, such as for example:

- a) ^{12}C : M4 resonances above 16 MeV which are closely spaced;
- b) ^{14}N : M4 resonances at 15.0, 16.9, 18.5, and 20.1 MeV;
- c) ^{16}O : M4 resonances at 17.8, 19.0 and 19.8 MeV;
- d) M6 resonances in 2s1d-shell nuclei, for example, the 14.4- and 11.6-MeV states in ^{28}Si .

7.8 Fast timing beta-delayed γ -ray spectroscopy

A. Korgul

Faculty of Physics, University of Warsaw, Warsaw, Poland

Ultra-Fast Timing measurements on neutron-rich nuclei have provided key information allowing a clear interpretation of the observed low-energy structure for a number of exotic nuclei. These measurements are complementary to direct in-beam lifetime measurements, Coulomb excitation, hyperfine interactions and beta-, gamma- or beta-delayed neutron spectroscopy.

The experimental setup includes a few detectors positioned in close geometry around the implantation point, where the mass-separated beam is continuously deposited creating a saturated source. Time-delayed information is provided by the β^- (START) and fast γ -detectors (LaBr₃(Ce) scintillator - STOP). In addition, a few Ge detectors are present. Triple coincidence $\beta\gamma\gamma(t)$ events are collected using the signals from the β -Ge-Ge and β -Ge-LaBr₃ detectors. The first data set allows the verification or construction of the decay scheme; the second is analyzed separately and allows for level lifetime measurements in the picosecond to nanosecond range.

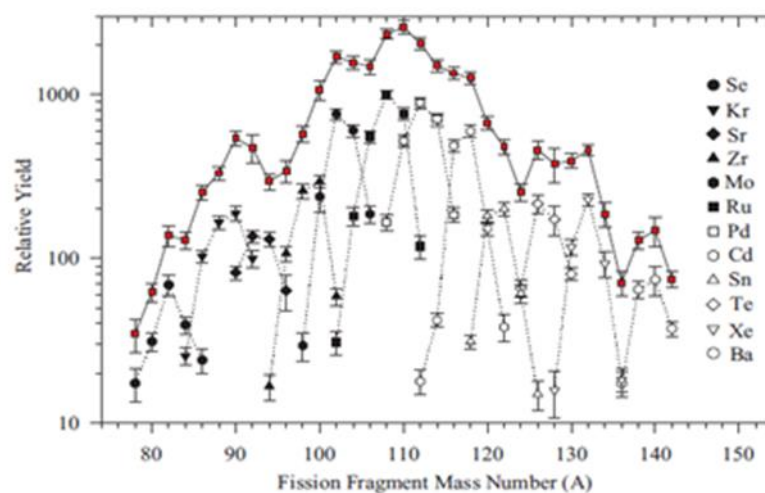

Fig.5 Relative fission fragment isotopic distribution from the reaction $^{208}\text{Pb}(^{18}\text{O},f)$ at $E=90$ MeV. Each complementary pair is represented by the same symbol with the light fragment shown by a filled symbol and the heavy fragment an open symbol [1].

The prospects for analogous experiments that might be possible at HIL using heavy-ion induced fission reactions, for example $^{208}\text{Pb}(^{18}\text{O},\text{f})$ (see Fig.5) or/and $^{232}\text{Th}(^{12}\text{C},\text{f})$ [1,2], are very interesting.

References:

[1] P. Banerjee *et al.*, Phys. Rev. C **92**, 024318 (2015).

[2] A. Ramaswami *et al.*, Journal of Radioanalytical and Nuclear Chemistry, **246**, 225 (2000).

7.9 γ -ray spectroscopy of fission products with a Gas-Filled Magnet

Ł. W. Iskra

*Istituto Nazionale di Fisica Nucleare, Sezione di Milano, Italy and
The H. Niewodniczański Institute of Nuclear Physics PAN, Kraków, Poland*

The measurements of fission observables in a variety of fissile systems is crucial for both experimental investigations as well as theoretical modeling. Moreover, the study of neutron-rich nuclei produced in such reactions is important for applications in astrophysics such as the r-process. For decades studies of the structure of neutron-rich nuclei have been conducted via γ -ray spectroscopy of products following spontaneous fission. They allow an investigation of the nuclear properties of hundreds of nuclei in the specific mass range. Efficient arrays of HPGe detectors, such as GAMMASPHERE [1], allow for high fold γ -ray coincidence analyses. However, only the ^{252}Cf and ^{248}Cm fission sources are available for such measurements. In order to extend the number of accessible nuclei, one can employ induced fission processes. About ten different fissile targets are available to perform such experiments with cold and/or thermal neutron beams leading to product distributions significantly different from those observed in spontaneous fission. This kind of measurement has recently been performed at the Institut Laue-Langevin (ILL) during the EXILL campaign [2], where an intense continuous neutron beam is produced by the reactor. Complementary experiments have taken place at IPN Orsay. In this case, fast neutrons from the LICORNE [3] set-up were employed in the $^{238}\text{U}(\text{n},\text{f})$ and $^{232}\text{Th}(\text{n},\text{f})$ reactions producing “exotic” fragments during the campaign named v-ball.

Detailed studies of the fission products with γ -ray spectroscopy techniques require at least triple γ -ray coincidence data which implies that only nuclei with yields of the order of 10^{-2} per fission or higher will be accessible. Additional information on the mass of one of the fragments would significantly improve the possibilities to identify new γ rays. Therefore, a concept was proposed to couple a high efficiency Ge array with a Gas-Filled Magnet (GFM) [4]. A design of the combined setup is being developed at ILL. During the fission process, the first fragment will be stopped in the target backing, providing a possibility for a Doppler-free prompt γ -ray spectroscopic measurement using a Ge detector array. The second fission product will be detected in the focal plane of the magnetic spectrometer allowing for its mass identification and isomer- or beta-delayed γ -ray spectroscopy.

We propose to employ the setup described above in proton-induced fission experiments at the Cyclotron Center Bronowice (CCB). The intense proton beam over a wide energy range available at CCB and the use of various targets will give the possibility of spectroscopic studies of some nuclei which are hard to reach otherwise.

For example, in the $^{232}\text{Th}(p,f)$ reaction poorly known nuclei in the “north-east” region of the doubly magic ^{78}Ni can be reached. Moreover, the Gas-Filled Magnet will be a movable device, which makes possible its use at HIL, where the mechanism of heavy-ion-induced fission reactions can be studied. The GFM might also be used in other types of experiments, especially in the context of the possible installation of a new cyclotron at HIL, which will provide high intensity heavy-ion beams.

References:

- [1] I. Y. Lee, Nucl. Phys. A **520**, 641c (1990).
- [2] M. Jentschel *et al.*, J. Instrum. **12**, P11003 (2017).
- [3] M. Lebois, J.N. Wilson *et al.*, Nucl. Instr. Meth. A **735**, 46 (2014).
- [4] P. Armbruster *et al.*, Nucl. Instr. Meth. **137**, 103 (1976).

Chapter 8

Nuclear Physics Applications

Conveners:

T. Matulewicz

Faculty of Physics, University of Warsaw, Warsaw, Poland

and

W.H. Trzaska

University of Jyväskylä, Jyväskylä, Finland

The beauty of science transcends its utility, but it is also a great joy and even our duty to develop applications directly benefiting society.

Jacek Jemielity (University of Warsaw), Pauza Akademicka 455 (2019)

Nuclear physics has made a substantial impact on the history, economy, and on nearly all other aspects of life throughout the 20th century. The substantial funding funnelled into nuclear research, resulted in many scientific breakthroughs that benefited and continue to benefit society.

The invention of the World Wide Web at CERN is but one of the many examples how money invested in basic nuclear and particle research yields impressive and totally unexpected inventions in seemingly unrelated areas. When in 1942 Enrico Fermi constructed the first reactor nobody envisioned that in two generations nuclear power would be the main source of electrical energy in many countries. Who would have imagined that the cyclotron, a 1930 invention by Ernest O. Lawrence⁷, would become a popular tool to treat cancer and produce radiopharmaceuticals? Were there any archaeologists expecting that a study of nuclear isotopes, their properties and origins would later allow them precisely to radiocarbon-date historical artefacts with the AMS (accelerator mass spectrometry) method?

Applied nuclear physics is well represented in Poland. This was exemplified by the large number of high-level talks on this topic at the Conference on the Future of Nuclear Physics in Poland held in HIL in 2019. The presentations on nuclear applications may be divided into two sub-categories: biomedical research, and materials research.

Biomedical research in Poland will be strongly supported through the construction of the CERAD⁸ facility at NCBJ Świerk. This facility will be centered around a new building housing a new cyclotron accelerating proton- and alpha-particle beams up to 30 MeV and deuterons up to 15 MeV. The beams will be used for the production of radioisotopes not accessible with the standard low-energy accelerators delivering 15 MeV protons. The CERAD project, with a price tag of 100 M PLN and expected completion in 2021, will benefit from the existing facilities at NCBJ Świerk including the high-flux research reactor MARIA and the dedicated laboratories of POLATOM.

⁷ https://en.wikipedia.org/wiki/John_H._Lawrence

⁸ <https://www.ncbj.gov.pl/cerad-news>

NCBJ Świerk will also house the NOMATEN⁹ project aimed at the production of new radioisotopes. NOMATEN is an EU-funded center-of-excellence established to design novel radiopharmaceutical materials for medical applications. The funding for NOMATEN is of the same scale as CERAD. While the NCBJ reactor MARIA is capable of producing a significant part of world demand for ⁹⁹Tc, cyclotrons could also be used for the production of this and several other radioisotopes needed for medical diagnosis and therapy procedures. One of the uses of particle beams are studies of radiation damage on individual cells. The Cyclotron Centre Bronowice¹⁰ (CCB) in Kraków is equipped with a modern therapeutic accelerator providing proton beams up to 235 MeV. Although this therapy method is well established, further developments are needed to improve the selectivity of irradiations and to reduce the exposure of healthy tissues. Novel PET technology, benefiting from many years of experience in the design and construction of particle detectors, is the basis of J-PET¹¹ - an advanced design developed at the Jagiellonian University in Kraków. This new diagnosis tool is still being developed and also has potential applications in basic research for testing CP, T and CPT symmetries in the decays of positronium atoms.

Materials research is the second important aspect of the NOMATEN project and of nuclear applications in general. Industry is interested in new materials, which might be high-temperature, corrosion and radiation-resistant. The development of these types of materials needs intensive particle beams, including neutrons from a reactor. Future research facilities, like FAIR, will operate at very high interaction rates. This is demanding both for the construction materials and for the next generation of particle detectors. The new detectors require tests with energetic particles. Currently, the most suitable facility in Poland would be the CCB operated beyond the fixed schedule of therapeutic irradiations. There is a large commercial market for radiation hardness tests of electronic components. At the same time, there is a shortage of accelerator facilities capable of meeting the demand. For instance, neither HIL nor CCB have the capacity to tap into this market. However, a new cyclotron, capable of delivering so-called cocktail beams of sufficient energy could, in addition to providing beams for basic and applied research, run a Radiation Effects facility with an annual income of the order of 1 M€.

The societal applications of nuclear physics are vast and growing. Development, maintenance, and operation of nuclear facilities is demanding but, in the long run, they offer multiple benefits to industry, to research, and society. For instance, numerous new applications involving the MARIA reactor clearly indicate that its operational life should be extended for the next three decades. In particular, neutron-based research and BNCT therapy should be fully exploited.

Biomedical physics has received a strong boost through the CERAD project. Here, the new cyclotron, built for the study and production of new radiopharmaceuticals, is the tool of choice. More energetic proton beams, although with a restricted time schedule, are available from CCB. The time accessible for research at CCB may drop in the future if the number of treated patients increases to match the full capacity of the facility. In that case a dedicated proton accelerator providing a 150 MeV beam might be considered

9 <http://nomaten.ncbj.gov.pl/>

10 <https://ccb.ifj.edu.pl/pl>

11 <http://koza.if.uj.edu.pl/pet>

to serve the needs of basic (e.g. few-body physics) and applied research (e.g. detector development and materials properties) currently using CCB beams.

Nevertheless, from the point of view of applied nuclear physics, replacement of the ageing heavy-ion accelerator at HIL with a modern machine coupled to an efficient ECR ion source of the latest generation, would be the best and the most cost-efficient investment. Synergy with top-level nuclear research is essential to progress in applications. The new cyclotron would be partially supported by the proceeds from radiation effect studies, would become an attractive tool for detailed investigations of high-LET doses on individual cells, and would supplement and provide low-energy support to the high-energy heavy-ion beams from SIS-100 at FAIR, etc.

8.1 CERAD@NCBJ

R. Mikołajczak

National Centre for Nuclear Research, Radioisotope Centre POLATOM, Świerk, Poland

The Center for Design and Synthesis of Radiopharmaceuticals for Molecular Targeting, CERAD¹² is a strategic research infrastructure entered on the Polish Road Map of Research Infrastructure. The aim of the project is to establish a modern research infrastructure within the field of new radiopharmaceuticals for diagnostics and therapy, based on ligands which are biologically active at the cellular and molecular level. Molecularly targeted pharmaceuticals constitute a special group of drugs using special biological mechanisms to deliver radioactive isotopes to the pathologically changed region for diagnostic or therapeutic purposes. The combination of isotopic techniques with molecular disease markers will enable earlier detection of diseases and implementation of relevant therapeutic procedures. Thus, CERAD addresses global social and demographic trends and challenges connected with the development of effective methods for the diagnosis and therapy of cancer and other civilization diseases. The CERAD infrastructure will be used for both research and commercial activities. The project combines the research potential of NCBJ as consortium leader and the partner institutions: University of Warsaw, Warsaw Medical University, Institute of Nuclear Chemistry and Technology, Jagiellonian University Medical College and Medical University of Białystok.

The elements of the CERAD infrastructure are: the MARIA nuclear reactor, the Świerk Computing Centre with specialist software for molecular modelling and dosimetric calculations, and the Pre-clinical Tests Laboratory and radiopharmaceutical facilities of POLATOM. Installation of a new high-current cyclotron at NCBJ, accelerating protons and alpha particles to 30 MeV and deuterons to 15 MeV, with the associated equipment and infrastructure, when combined with the existing scientific base creates unique and pro-development research capabilities in Poland. The 30 MeV cyclotron will extend the existing basis with an additional spectrum of medically attractive radionuclides which cannot currently be obtained in Poland, and the costs for the provision of which from abroad are very high (e.g. ¹²³I, ⁴⁴Sc). CERAD will be a platform for conducting comprehensive studies directed at searching for and designing new medicinal products, in particular

¹² The CERAD project is financed under the Smart Growth Operational Programme 2014-2020, Priority IV, Measure 4.2.

radiopharmaceuticals, and implementing diagnostic and therapeutic procedures for diseases which are currently treated ineffectively.

8.2 Materials studies

Ł. Kurpaska

National Centre for Nuclear Research, Świerk, Poland

The overall objective of the NOMATEN [1] project is to establish a Centre of Excellence (CoE) in Multifunctional Materials for Industrial and Medical Applications that will exploit unique nuclear research infrastructure and expertise from Poland and Europe. The long-term vision for the NOMATEN CoE will be to provide world-class research and development of innovative multifunctional materials – materials combining advanced structural and functional properties – for industrial and medical applications.

To achieve this vision, the CoE will be created by three consortium partners with complementary facilities and expertise: Narodowe Centrum Badań Jądrowych (NCBJ), Poland; Commissariat à l'Énergie Atomique et aux Énergies Alternatives (CEA), France; Teknologian Tutkimuskeskus VTT Oy (VTT), Finland.

They will be supported by Narodowe Centrum Badań i Rozwoju (NCBiR) – an implementing agency of the Ministry of Science and Higher Education of Poland – which is the fourth consortium partner. The consortium partners will develop and execute a long-term science and innovation strategy for the CoE that focuses on two strategic research and innovation topics:

- Novel high-temperature, corrosion and radiation resistant materials for industrial applications
- Novel radiopharmaceutical materials for medical applications.

This strategy will enable the CoE to address specific research and innovation needs of Poland and Europe in the fields of materials sciences, harsh-environment industrial processes, and nuclear medicine.

References:

[1] <http://nomaten.ncbj.gov.pl/>

8.3 Neutrons in interdisciplinary and nuclear studies

R. Prokopowicz, M. Gryziński

National Centre for Nuclear Research, Świerk, Poland

The MARIA nuclear reactor is a high neutron flux research facility. It is operated by the National Centre for Nuclear Research in Świerk near Warsaw. It is an open pool, pressurized fuel channel, beryllium moderated reactor. Its nominal thermal power of 30 MW and high thermal neutron flux make it one of the highest performance research reactors in the world. For the last 14 years the reactor has operated continuously, working over 4500 h per year. Unlike most of research reactors in the world currently being shut down, the MARIA reactor is expected to operate until 2050.

The MARIA reactor is equipped with a number of various vertical channels located inside the reactor core. The vertical channels are used to expose targets to neutrons. The neutron energy spectrum of the reactor is stretched from fast fission neutrons (ca. 1-2 MeV) down to thermal neutrons (i.e. in thermal equilibrium with the surroundings – ca. 25 meV). The neutron flux and energy spectrum vary from channel to channel. Some channels are devoted to fast neutrons only, whereas others have a well thermalized or broad spectrum. The thermal neutron flux achieves $2 \cdot 10^8 \text{ cm}^{-2} \text{ s}^{-1}$, whereas the fast neutron flux achieves $3 \cdot 10^8 \text{ cm}^{-2} \text{ s}^{-1}$ inside the reactor core.

In addition to the standard channels, a thermal neutron driven ^{252}Cf 14 MeV neutron source is located inside the core. Thermal neutrons are used for activation whereas fast neutrons mostly for material modification. The in-core channels can be used to investigate or verify neutron reaction cross sections, e.g. by restoring the conditions occurring during the s-process considered in nuclear astrophysics.

The reactor is also equipped with seven horizontal channels guiding thermal (six channels) or fast neutrons (one channel) outside the reactor. The horizontal channels are used to investigate solid state properties, neutron diffraction, and interference. They are also used for neutronography and autoradiography, investigation of works of art or devices, biomedical research and for industrial applications.

The installation of a cold neutron source inside the MARIA reactor core is also being considered. Cold neutrons are to be guided long-distance from the reactor building. They can be used to investigate neutron quantum properties, including their impact on such research fields as the Standard Model, baryogenesis, gravity interaction on the quantum scale, dark matter and dark energy quests.

It should also be noted that the nuclear reactor can be used in nuclear physics research as a strong positron source (guided outside the facility). The reactor is also a very strong antineutrino source. With a yield of $5 \cdot 10^{18} \text{ s}^{-1}$ it exceeds the solar neutrino impact at 25 m distance from the reactor core. Such a source could be used for neutrino investigations, e.g. neutrino oscillations.

8.4 Prompt gamma imaging for online monitoring in proton therapy - the SiFi-CC project

A Wrońska for the SiFi-CC collaboration
Jagiellonian University, Kraków, Poland

Over the past five years the number of proton therapy centers in the world has doubled. In Poland a new proton therapy facility at the Cyclotron Centre Bronowice (CCB) was launched in Kraków in 2013. The accuracy of proton therapy could be improved if on-line monitoring of the deposited dose became standard in clinical practice. Different approaches for beam range verification (one-dimensional) or monitoring of the deposited dose distribution (two- or three-dimensional) are being developed, exploiting different types of secondary radiation. One of these is prompt gamma imaging, for which detectors of the Compton-camera type featuring 3D reconstruction allow the richest information to be obtained.

Physicists from the Jagiellonian University and the RWTH Aachen University have established a collaboration to develop a method for on-line monitoring of the dose distribution deposited in proton therapy exploiting prompt gamma radiation. In the first project called γ CCB the relevant differential yields for gamma emission were measured at HIT Heidelberg and CCB Kraków. The new project focuses on development of a dedicated setup for prompt gamma imaging, which will take advantage of the latest advances in scintillation detectors - fibers made from modern, heavy scintillators read out by SiPMs, hence the project name SiFi-CC (SiPMs and scintillating Fiber-based Compton Camera). The setup will have two modes of operation: as a Compton camera (CC), and as a coded-mask detector (CM). The CM system will consist of a multilayer array of scintillation fibers and a massive collimator with a specially designed pattern, and the CC system will be constructed of two arrays of fibers. The use of heavy scintillating fibers ensures high detection efficiency, excellent time resolution and good light output. The results of the initial simulations indicate that the energy and position resolutions are also sufficient. The high degree of detector granularity and the short duration of the signals ensures high rate capability. Data from the detectors will be collected and processed by a modern data acquisition system, based on FPGA technology. This solution provides the high throughput as well as the system flexibility needed to handle the two modes of operation.

The essential part of the detector development are tests in close-to-clinical conditions. The experimental room available at the CCB would make a perfect environment for such tests if it were equipped with a laser guiding system and a beam nozzle of the same type as those used in the therapy rooms. Installation of such a nozzle would allow the determination of the beam intensity and phase-space at the exit of the ion pipe. The first is important for absolute normalization of experimental results, the second is crucial for simulations of expected detector response. This additional equipment would be beneficial not only for the present project, but also for other physics experiments at CCB.

Proton therapy owes its rapidly growing popularity to the unique character of the interaction of protons with the medium traversed. Unlike X rays used in conventional radiotherapy, for which the maximum of the deposited dose is very close to the surface and the location of which cannot be modified, for protons the maximum – called the Bragg peak – is close to the proton range in the medium. This range is proton energy-dependent, which - together with the use of pencil beams and systems of scanning magnets called gantries – gives access to unprecedented conformality of deposited dose [1]. However, even this very precise and selective treatment method can be improved, e.g. by reducing clinically applied safety margins ranging currently from a few millimeters up to over a centimeter, depending on the tumor location [2]. One way to implement such an improvement is in the monitoring of the deposited dose distribution in vivo and in situ, allowing whether the irradiation is proceeding in accordance with the treatment plan to be controlled. Development of such tools would bring proton therapy to a new level of accuracy, opening it up as an option for new patient categories and reducing side effects [3]. Among the by-products of the interaction of protons with the patient's tissue are gamma quanta emitted from the excited nuclei of the tissue atoms, with typical energies of 1-7 MeV. The spectral and spatial characteristics of this so-called prompt gamma (PG) radiation (prompt, because the typical emission times are of the order 10^{-15} - 10^{-12} s) were shown to be strongly correlated with the proton range [4–6]. This is the physics basis of a group of projects aimed at the development of setups for online monitoring of proton therapy by means of prompt gamma detection, a comprehensive review of which can be found e.g. in [7].

A group of physicists from the Jagiellonian University in Kraków and RWTH Aachen University is also active in this field. In our first project called γ CCB, performed together with colleagues from IFJ PAN Kraków and the University of Silesia, we studied the details of the prompt gamma emission, contributing absolutely normalized data to the very scarce world data base [6,8,9]. The experiments were carried out using the infrastructure of the Heidelberg Ion Beam Therapy Centre (HIT) and Cyclotron Centre Bronowice, an example of the results obtained is presented in Fig.1.

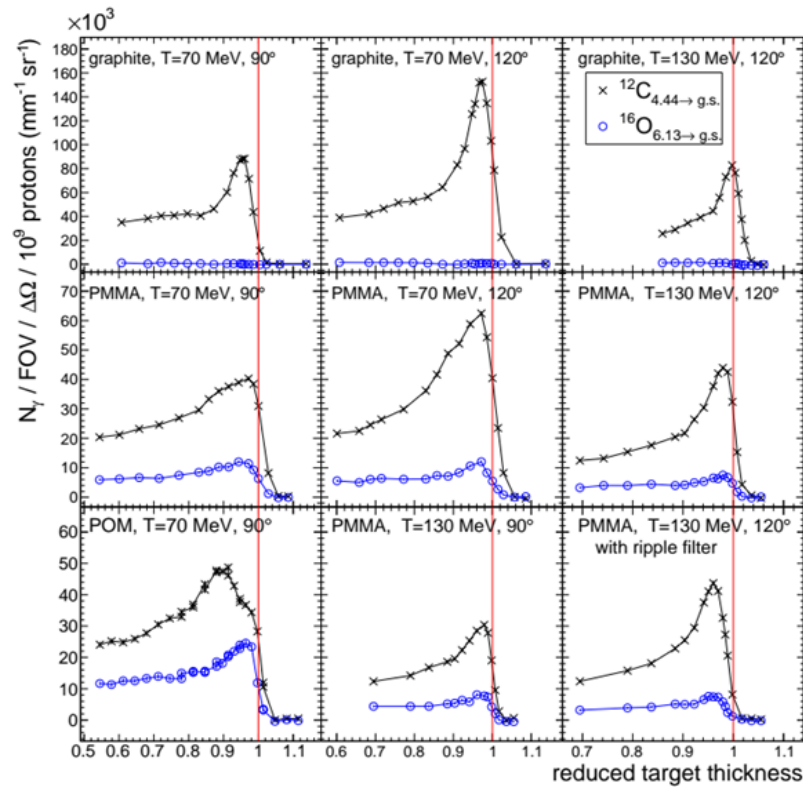

Fig.1 Normalized intensity of prompt gamma radiation emitted from a phantom irradiated with a proton beam. Phantom material, emission angle and beam energies are given in each panel. The horizontal axis represents depth in the phantom in units of beam range in the material concerned. Reprinted from [6].

The second project of the Kraków-Aachen collaboration is called SiFi-CC, which stands for a SiPM- and heavy scintillation Fiber-based Compton Camera, and is aimed at the development of a setup for on-line monitoring of deposited dose distribution in proton therapy. The project takes advantage of recent developments in the fields of inorganic scintillating fibers and silicon photomultipliers. Equipped with an FPGA-based, fast and flexible data acquisition system (DAQ), the setup has the chance to overcome the difficulties faced by other groups, such as insufficient detection efficiency and rate capability or large background from random coincidences. The project is an example of the implementation of high-energy physics technologies in medical physics, which has turned out successfully many times before.

A Compton camera in its classical form is a detector consisting of two modules, a so-called scatterer and an absorber, and relies on the detection of events in which a gamma quantum is Compton-scattered in the scatterer and subsequently undergoes a photoeffect in the absorber. By recording energy depositions and their spatial coordinates in both

modules, it is possible to reconstruct a cone of possible directions of the impinging gamma. A superposition of many of such cones forms a three-dimensional image. In SiFi-CC both modules will consist of fibers made of heavy scintillator, arranged into stacked layers. Fibers will be read out by SiPMs from both sides, as depicted in Fig.2. Moreover, after building the first module, we will test it in coded-mask mode by adding a passive tungsten collimator of a specially designed pattern. Coded mask telescopes are used in astronomy in searches for gamma sources, but have not been tested before for proton therapy monitoring.

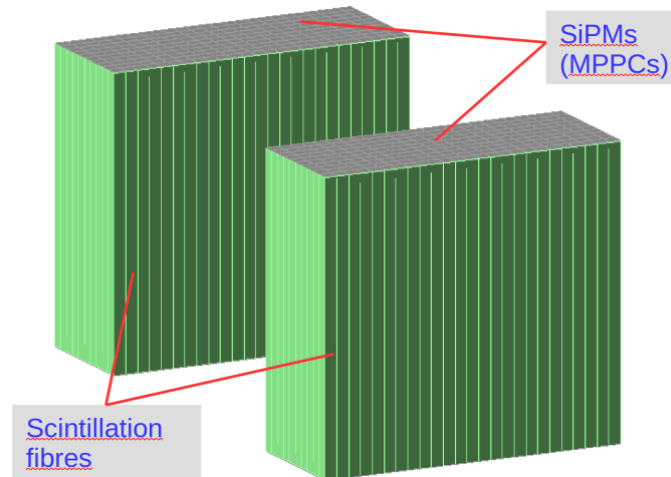

Fig.2 A sketch of the SiFi-CC setup: layers of scintillating fibers read out from both ends by silicon photomultipliers, stacked into two modules forming a Compton camera.

Currently, several fronts are open in the R&D of SiFi-CC. In the first step, the feasibility of the design and its usefulness for proton therapy monitoring has been verified in a series of Monte-Carlo simulations. For this purpose, a detailed detector model, including the scintillator properties, influence of fiber wrapping, optical coupling and SiPM properties was built. The simulation of the detector performance needed to be benchmarked with experimental results. Therefore, in parallel we performed a laboratory survey of several heavy scintillating materials: GAGG, LuAG and LYSO, all for the same fiber dimensions $1 \times 1 \times 100 \text{ m}^3$ which were determined by preliminary simulations as the optimal building blocks for the setup. The materials for the tests were selected based on their chemical composition (gamma detection efficiency increases with effective atomic number) and signal decay time (fast scintillators are favored). The survey, performed on a dedicated test bench, allowed us to compare such features as energy and time resolution, light output and attenuation length. Based on the results obtained [10], [11] we selected LYSO which, besides very good performance, has a moderate price and is widely available. Good timing properties of this material in combination with high granularity of the detector will allow the problem of pile-up to be reduced. A preliminary version of a LYSO-fibers based Compton camera with optimized dimensions and distances was described in Ref. [12]. Expected detector response to a flux of gammas realistically mimicking one stemming from proton therapy was analyzed in that paper with respect to the distribution of energy depositions, fiber hit multiplicities and event rates. The bottom line is that the proposed setup has sufficient efficiency and rate capability to serve for range verification in proton therapy even on the basis of the statistics from a single irradiated target voxel, and effects like pile-up and random coincidences are within acceptable limits. The spatial resolution of the reconstructed image strongly depends on the event selection algorithm applied before reconstruction, and this is still under development and

optimization. Other tasks, such as construction of front-end and DAQ electronics are also in progress. For the latter, the development is in synergy with another project from Kraków – J-PET [13].

In the near future a small-scale prototype module consisting of four layers will be brought into operation. A photo of its fiber stack is shown in Fig.3. The prototype tests will give us a chance to validate our simulations not only on a single-fiber basis, but also for a collection of fibers, and check for collective effects such as optical and electronic cross-talk. The measurements will be performed first in the laboratory, using radioactive sources. However, the energy of the gammas emitted from the most common radioactive sources are small compared to those of PG.

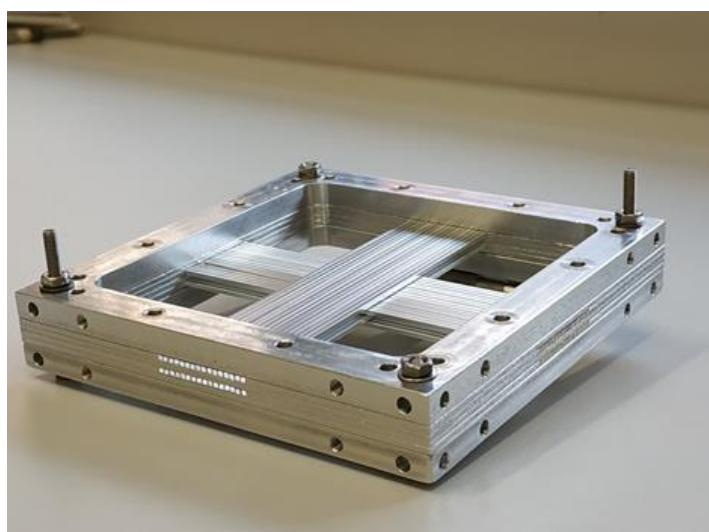

Fig.3 Photograph of a small-scale prototype of a SiFi-CC module.

Therefore, further tests with the proton beam, in close-to-clinical conditions are desired. They are planned at the Cyclotron Centre Bronowice. Its experimental hall offers enough space and the neighboring laboratories are well equipped with auxiliary tools. The main difficulty, however, is in the control of the beam distribution and intensity. From the point of view of the SiFi-CC tests, a perfect solution would be to have the beam pipe exit window equipped with a nozzle of the same type as those mounted in the treatment rooms. The nozzle could be used to build a beam model, which would be useful in simulations of beam-target overlaps etc., crucial in particular for small-target experiments. A laser guiding system would help in fast positioning of the irradiated objects, reducing access and beam time needed for experiments and thus leading to a more efficient use of the infrastructure.

We acknowledge the support of the Foundation for Polish Science within the POMOST program as well as of the Polish National Science Centre through the grant SONATA BIS No. 2017/26/E/ST2/00618.

References:

- [1] U. Linz, Ed., Ion Beam Therapy. Heidelberg, Dordrecht, London, New York: Springer, 2012.
- [2] H. Paganetti, “Range uncertainties in proton therapy and the role of Monte Carlo simulations,” *Phys. Med. Biol.*, vol. 57, no. 11, pp. R99–R117, Jun. 2012.
- [3] NuPECC, report “Nuclear Physics for Medicine,” 2014.

- [4] C.-H. Min, C. H. Kim, M.-Y. Youn, and J.-W. Kim, “Prompt gamma measurements for locating the dose falloff region in the proton therapy,” *Appl. Phys. Lett.*, vol. 89, no. 18, p. 183517, Oct. 2006.
- [5] M. Pinto et al., “Absolute prompt-gamma yield measurements for ion beam therapy monitoring,” *Phys. Med. Biol.*, vol. 60, no. 2, pp. 565–594, Jan. 2015.
- [6] L. Kelleter et al., “Spectroscopic study of prompt-gamma emission for range verification in proton therapy,” *Physica Medica*, vol. 34, pp. 7–17, 2017.
- [7] A. Wrońska, “Prompt gamma imaging in proton therapy - status, challenges and developments,” *J. Phys. Conf. Ser.*, vol. 1561, p. 012021, 2020.
- [8] A. Wrońska et al., “Gamma emission in hadron therapy - Experimental approach,” *Acta Phys. Pol. B*, vol. 46, no. 3, pp. 753–756, 2015.
- [9] A. Wrońska et al., “Experimental verification of key cross sections for prompt-gamma imaging in proton therapy,” *Acta Phys. Pol. B*, vol. 48, no. 10, 2017.
- [10] K. Rusiecka, J. Kasper, A. Magiera, A. Stahl, and A. Wrońska, “Investigation of the Properties of the Heavy Scintillating Fibers for Their Potential Use in Hadron Therapy Monitoring,” in *Engineering of Scintillation Materials and Radiation Technologies, Selected Articles of ISMART2018*, M. Korzhik and A. Gektin, Eds. Springer, 2019, pp. 195–210.
- [11] A. Wrońska et al., “Characterization of components of a scintillation-fiber-based Compton Camera,” *Acta Phys. Pol. B*, vol. 51, no. 1, pp. 17–25, 2020.
- [12] J. Kasper et al., “The SiFi-CC project – Feasibility study of a scintillation-fiber-based Compton camera for proton therapy monitoring,” *Physica Medica*, vol. 76, pp. 317–325, Aug. 2020.
- [13] P. Moskal et al., “J-PET: A Novel TOF-PET Detector based on Plastic Scintillators,” in *2016 IEEE Nuclear Science Symposium, Medical Imaging Conference and Room-Temperature Semiconductor Detector Workshop (NSS/MIC/RTSD)*, 2016, pp. 1–3.

8.5 Application of nuclear physics in studies of discrete symmetries, quantum entanglement and positronium imaging with the J-PET tomograph

P. Moskal on behalf of the J-PET Collaboration

Marian Smoluchowski Institute of Physics, Jagiellonian University, Kraków, Poland

The newly constructed Jagiellonian Positron Emission Tomograph (J-PET) is the first PET tomograph built from plastic scintillators [1-8]. J-PET is a unique facility for interdisciplinary research in the fields of physics, biology and medicine. As a detector optimized for the registration of photons from electron-positron annihilations, it enables tests of discrete symmetries in decays of positronium atoms via the determination of the expectation values of the discrete-symmetries-odd operators, which may be constructed from the spin of the ortho-positronium atom and the momenta and polarization vectors of photons originating from its annihilation [9-12]. It also enables a study of the entanglement of photons originating from positronium annihilations [13,14] and research and development in positron emission tomography and newly developed positronium imaging [15-19].

With respect to the previous experiments performed with crystal-based detectors, J-PET being built of plastic scintillators provides superior time resolution, higher granularity, lower pile-up, and the opportunity of determining the photon polarization through the registration of primary and secondary Compton scatterings in the detector. These features make J-PET capable of improving present experimental limits in tests of discrete symmetries in decays of the positronium atom (a purely leptonic system).

The prospects and clinical perspectives of J-PET imaging using plastic scintillators were described in a recent article [19]. In contrast to current crystal-based PET scanners, the J-PET tomography system is based on axially arranged low-cost plastic scintillator strips. It constitutes a realistic cost-effective solution for total-body PET for broad clinical applications [19]. The high sensitivity of total-body J-PET and trigger-less data acquisition enable multi-photon imaging, opening possibilities for multi-tracer and positronium imaging, thus promising quantitative enhancement of specificity in cancer and inflammatory disease assessment [19]. At present one of the main focuses of the J-PET collaboration is the development of a novel method of positronium imaging of the human body [15-19]. Positrons injected into the human body create in more than 40% of cases a bound state of an electron and a positron, the positronium atom. Currently, in the PET technique, the phenomenon of positronium production is neither recorded nor used for imaging. Using the J-PET detector we have shown that properties of positronium atoms such as the (environment modified) life time and production probability, as well as the 3γ to 2γ rate ratio can be obtained during a routine PET imaging and may deliver information useful for in-vivo cancer diagnosis and grading [15-19].

References:

- [1] P. Moskal et al., Nucl. Instr. and Meth. A 764, 31 (2014).
- [2] P. Moskal et al., Nucl. Instr. and Meth. A 775, 54 (2015).
- [3] P. Moskal et al., Phys. Med. Biol. 61, 2025 (2016).
- [4] L. Raczynski et al., Phys. Med. Biol. 62, 5076 (2017).
- [5] M. Palka et al., Journal of Instrumentation 12, P08001 (2017).
- [6] Sz. Niedzwiecki et al., Acta Phys. Polon. B 48, 1567 (2017).
- [7] P. Kowalski et al., Phys. Med. Biol. 63, 165008 (2018).
- [8] G. Korcyl et al., IEEE Transactions On Medical Imaging 37, 2526 (2018).
- [9] P. Moskal et al., Acta Phys. Polon. B 47, 509 (2016).
- [10] A. Gajos et al., Nucl. Instr. and Meth. A 819, 54 (2016).
- [11] D. Kaminska et al., Eur. Phys. J. C 76, 445 (2016).
- [12] A. Gajos et al., Advances in High Energy Physics 2018, 8271280 (2018)
- [13] P. Moskal et al., Eur. Phys. J. C 78, 970 (2018).
- [14] B. Hiesmayr, P. Moskal, Scientific Reports 7, 15349 (2017).
- [15] P. Moskal, 2019 IEEE NSS/MIC 2019, DOI: 10.1109/NSS/MIC42101.2019.9059856.
- [16] P. Moskal et al., Phys. Med. Biol. 64 (2019) 055017
- [17] P. Moskal et al., EJNMMI Physics 7 (2020) 44
- [18] P. Moskal, B. Jasińska, E. Ł. Stępień, S. Bass, Nature Reviews Physics 1 (2019) 527
- [19] P. Moskal, E. Ł. Stępień, PET Clinics 2020, <https://doi.org/10.1016/j.cpet.2020.06.009>

8.6 How to test electronics used in Space?

M. Paluch-Ferszt, Z. Szepliński, U. Kaźmierczak

Heavy Ion Laboratory, University of Warsaw, Warszawa, Poland

Our sun emits a large number of charged and uncharged particles including protons, heavy ions and neutrons. The radiation environment close to Earth is divided into two categories: particles trapped in the Van Allen belts and transient radiation. The energy levels of these particles can range from keV up to GeV [1].

Spaceborne instruments carry many electronic devices including micro-processors, registers in digital circuits, Analog-Digital Converters (ADCs) etc. If a charged particle from space strikes a sensitive node of an electronic circuit it may cause disruption or permanent damage [2].

There are two primary ways that radiation can affect electronics: the total ionizing dose (TID) and single event effects (SEEs). TID is a long-term failure mechanism vs. SEE, which is an instantaneous failure mechanism. SEE is expressed in terms of a random failure rate, whereas TID is a failure rate that can be described by a mean time to failure [3]. SEEs are caused by a single, energetic particle, and can take on many forms. Single Event Upsets (SEUs) are soft errors, and non-destructive. They normally appear as transient pulses in logic or support circuitry, or as bitflips in memory cells or registers. Several types of hard errors, potentially destructive, can appear: Single Event Latch-up (SEL) results in a high operating current, above device specifications, and must be cleared by a power reset. Other hard errors include Burnout of power MOSFETS, Gate Rupture, frozen bits, and noise in CCDs. In the space environment, electronics designers have to be concerned with two main causes of SEEs: cosmic rays and high energy protons. For cosmic rays, SEEs are typically caused by their heavy ion component. These heavy ions cause a direct ionization SEE, i.e., if an ion traversing a device deposits sufficient charge an event such as a memory bit flip or transient may occur. Cosmic rays may be galactic or solar in origin. Protons, usually trapped in the earth's radiation belts or from solar flares, may cause direct ionization SEEs in very sensitive devices. However, a proton may more typically cause a nuclear reaction near a sensitive device area, and thus create an indirect ionization effect potentially causing a SEE [4].

Circuit quality control testing is required prior to the launching of space instruments in order to find out where the sensitive nodes are and also to protect against a charged particle strike [2]. In order to be able to test electronics used in space, one should have access to accelerators with protons up to 40 MeV and heavy ions at energies as high as 55 MeV/nucleon. The protons are available, after energy degradation, at CCB Krakow, but there is no heavy ion accelerator with such high energies in Poland at the present time.

A superconductor is a material which, when cooled below a certain temperature, called the critical temperature, T_c , has exactly zero electrical resistance. This amazing property of a superconductor can be maintained if the current density flowing through the superconducting material is smaller than the critical current density and also any external magnetic field is lower than the critical one. The critical temperature T_c , critical current density J_c and critical magnetic field H_c are the most basic characteristics of a superconducting material. Superconductors can be manufactured as bulk or thin film materials [5]. Second generation (2G) high temperature superconductor tapes (HTS) enable the generation of strong magnetic fields that do not require the use of a high-power direct current power supply, just like typical electromagnets. The tape is 12 mm wide and has the thickness of a sheet of paper. It can conduct up to 600 A at a temperature of 77 K before the superconducting state is destroyed [6]. The REBa₂Cu₃O_{7-x} superconductor tape, also called "(RE)BCO", is produced by ion beam-assisted deposition (IBAD) and metal-organic chemical vapor deposition (MOCVD) [7]. The tape structure is shown in Fig.4.

The small dimensions and weight of the tape are very promising features for the construction of magnetic shields protecting crews of spacecraft against cosmic radiation [9]. The exposure of astronauts to cosmic rays is one of the most dangerous factors threatening life and health in long manned missions [10, 11]. Cosmic radiation can also cause damage to the equipment of a spaceship. Therefore, it is necessary to examine how cosmic radiation changes or destroys the superconducting properties of HTS 2G tapes.

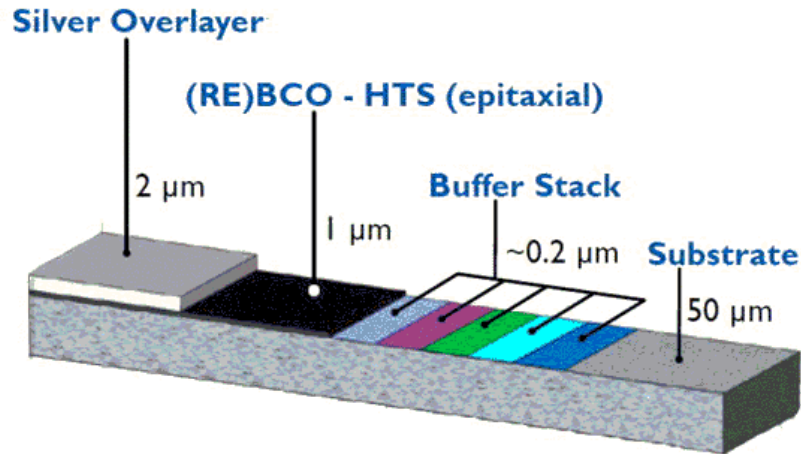

Fig.4 Illustrative drawing of the (RE)BCO tape structure [8].

As preliminary research into cosmic applications of these materials we irradiated samples of 2G HTS tapes with $^{12}\text{C}^{+3}$ heavy ions with a minimum depth of $40\ \mu\text{m}$ in the tape material. In the ideal case the tape should be irradiated with types and energies of ions which correspond to real cosmic radiation like the solar wind and high-energy radiation originating from outside the Solar System [12]. The rectangular shaped samples of 2G HTS tapes were 10 mm long and had a width of 6 mm. Two samples were inserted into the irradiation chamber in one experimental run. The samples were mounted on a Carousel and inserted into the vacuum chamber. The Carousel with tapes is shown in Fig.5. Irradiation used the maximum kinetic energy of the ions and the maximum fluence (number of particles per square cm per second). The tape was oriented in such a way that the superconducting layer was towards the ion source.



Fig.5 Two samples of 2G HTS mounted on the Carousel [13].

In cooperation with the AGH University of Science and Technology in Krakow the superconducting properties of the irradiated samples will be studied by AC and DC magnetic susceptibility and magneto-transport measurements. The superconducting

parameters like critical temperatures T_c , T_{c0} and critical current density J_c will be evaluated [13]. The microstructure of the tapes and structural damage resulting from irradiation will be examined by scanning electron microscopy.

References:

- [1] Ch. Leonard, Challenges for Electronic Circuits in Space Applications, <https://www.analog.com/en/technical-articles/challenges-for-electronic-circuits-in-space-applications.html>
- [2] R. Mani, Understanding the Single Event Effect (SEE), <https://alliedscientificpro.com/blog/welcome-to-our-blog-1/post/understanding-the-single-event-effect-see-65>
- [3] J. Wyss, Neutrons for radiation hardness studies: neutron induced single event effects, <http://www.lnl.infn.it/~lnldir/Seminario%20sorgenti/PDF/Wyss.pdf>
- [4] M. Niknahad, Using Fine Grain Approaches for Highly Reliable Design of FPGA-based, KIT Scientific Publishing, (2013) 21-22.
- [5] M. Tinkham, G. McKay, Introduction to superconductivity 2nd edn., New York (1996).
- [6] D.W. Hazelton, <http://www.superpower-inc.com/system/files/WAMHTS1.pdf>
- [7] http://www.superpower-inc.com/system/files/2010+DOE+Peer+Rev_2G+FINAL.pdf
- [8] A. Patel et al., Trapped fields greater than 7 T in a 12 mm square stack of commercial high-temperature superconducting tape, Appl. Phys. Lett. 102 (2013) 102601.
- [9] R. Battiston et al., <https://arxiv.org/abs/1209.1907>
- [10] R. Kerr, Science 340 (2013) 1031.
- [11] C. Zeitlin et al., Science 340 (2013) 1080.
- [12] S. Nerlich, <https://www.universetoday.com/86490/astronomy-without-a-telescope-oh-my-god-particles/>
- [13] W.M. Woch et al., J. Supercond. Nov. Magn. 30 (2017) 569-574.

8.7 Testing the response of detectors with high-energy protons at CCB

M. Ziębliński, B. Sowicki, M. Ciemała et al.

The H. Niewodniczański Institute of Nuclear Physics PAN, Kraków, Poland

and the CALIFA, FAZIA, PARIS Collaboration

The Proteus C-235 isochronous cyclotron at the Cyclotron Center Bronowice of the IFJ PAN in Krakow delivers a monoenergetic proton beam of 230 MeV which can be very quickly attenuated (in times of tens of seconds) to any energy down to 70 MeV with the energy selector systems. The energy dispersion $\Delta E/E < 0.7\%$ and beam intensity from 600 nA to 0.1 nA makes this infrastructure ideal for testing the response of different detector arrays to protons. So far, tests have been performed by different international collaborations on elements of such detector systems as CALIFA (see Fig.6), FAZIA and PARIS (see Fig.7).

These arrays of detectors dedicated to the detection of gamma ray or charged particle energies consist of phoswiches of newly developed scintillators like LaBr₃, LaCl (PARIS, CALIFA) or the better known CsI (FAZIA). The responses of detectors to stopped and punched-through protons were measured and pulse shape analyses of signals carried out in a series of experiments in the experimental hall of CCB. A new energy reconstruction method (iPhos) was used. The behavior of the FAZIA FEE located in the vacuum chamber in order to minimize the detector-preamplifier-digitizer distance was tested. Likewise, the long-term behavior of detector elements was investigated by proton irradiation.

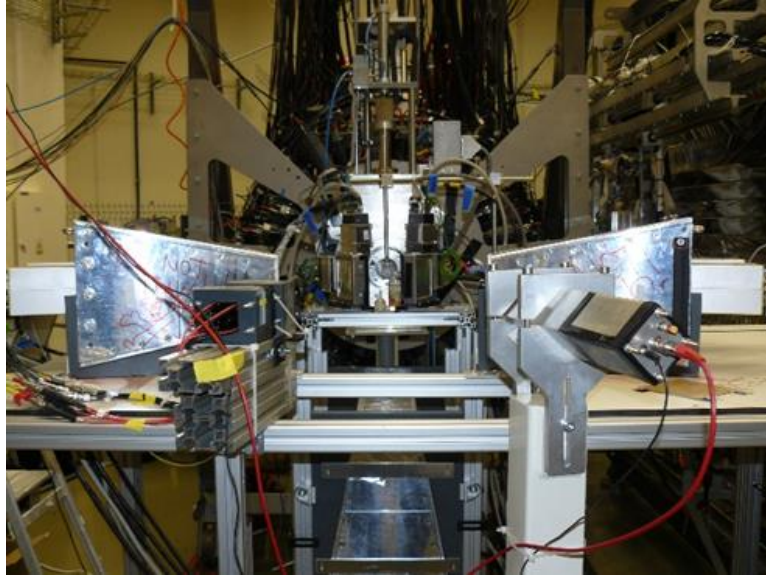

Fig.6 CALIFA petals in the experimental hall at CCB

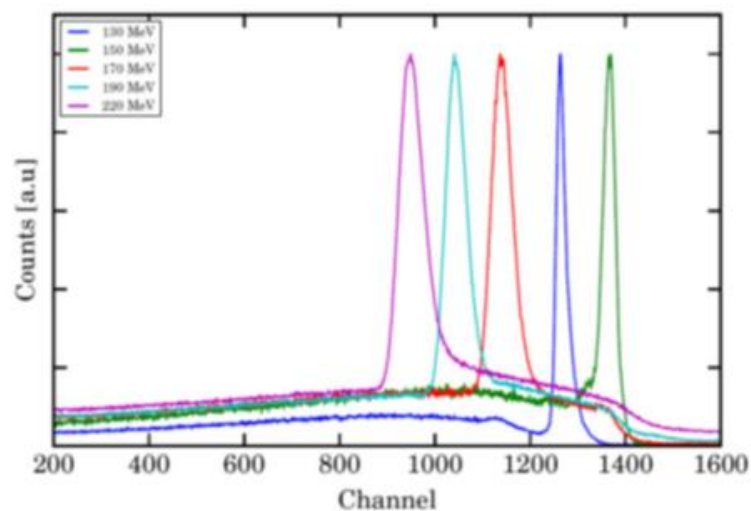

Fig.7 Spectra of protons for a 2"x2"x2" LaBr₃ from the PARIS detector for different energies (130-220 MeV). The spectra are normalized to have the same height of the proton peak.

8.8 Challenges in radiobiology research with heavy ion beams in Poland

U. Kaźmierczak¹, Z. Szepliński¹, M. Paluch-Ferszt¹, M. Filipek^{1,2}

¹ Heavy Ion Laboratory, University of Warsaw, Warszawa, Poland

² Faculty of Physics, University of Warsaw, Warszawa, Poland

Radiobiology is an interdisciplinary field of science, on the border of nuclear physics, biology and medicine. It deals with the study of the influence of ionizing radiation on living organisms. One of the areas of radiobiological research is the analysis of the biological response of cells irradiated with heavy ions. The effects of the interaction of heavy charged particles with biological material analyzed at the cellular or molecular level are of fundamental importance in the field of biomedical applications, especially in hadronotherapy (therapy in which irradiation of the tumor is carried out with heavy ions).

Research in radiation biology develops knowledge about the effects of radiation in cells, tissues, organs and organisms. Discoveries and fundamental biological insights realized through these studies have led, for example, to innovations and progress in radiation oncology [1].

In radiobiological cellular experiments with a broad ion beam, regardless of its horizontal [2] or vertical orientation [3], the number of ion tracks registered in an individual cell varies over the population of cells due to the Poisson distribution. It is a serious problem for high-LET ions, where at low doses the fraction of cells in which no ion track was registered can be very high. To overcome the problem and target single cells with a predefined number of particles microbeams were developed in the last decade of the past century [4].

Today ion microbeams are important tools in radiobiological research. These facilities provide unique features to study targeted and non-targeted radiation response as well as radiation-induced DNA damage and repair. There is growing interest in using charged particles to generate highly localized DNA damage since they offer the advantage of a well characterized dosimetry and a better understanding of the physical and biochemical processes of damage induction in comparison to laser microirradiation, commonly used in the DNA repair community [5]. Unfortunately, the worldwide number of ion microbeam facilities where biological experiments can be performed is limited. Even fewer facilities combine ion microirradiation with fluorescent labelling and advanced fluorescence microscopy, allowing for online observation of cellular response reaction starting very soon after irradiation [6].

In Poland there are currently only two radiobiological facilities with ion beams: the ion microbeam at the van de Graaf accelerator (IFJ PAN, Kraków) [7] and the Warsaw cyclotron facility with a horizontal broad ion beam (Heavy Ion Laboratory at the University of Warsaw, Warsaw) [8].

Radiological experiments at HIL focus on the analysis of two issues: the local dose of the carbon ion beam obtained in radiobiological studies at the Biology Laboratory (at HIL) and its role in the biological response of mammalian cells in vitro [9].

During the past 20 years numerous scientific reports have appeared claiming that factors and signals emitted by cells directly irradiated with heavy ions may reduce the survival rate or lead to mutations in non-irradiated cells. This phenomenon was called the bystander effect. It may be important in the development of adverse effects of radiotherapy, e.g. by increasing the risk of secondary neoplasm initiation.

The bystander effect is mainly observed in in vitro experiments during the irradiation of cells with very low doses (in the mGy or cGy range) of α radiation, as well as X and γ radiation. Contrary to these reports, there are publications pointing to non-occurrence of the bystander effect in various cell lines, demonstrated during clonogenic tests or chromosomal aberrations. In order to test these contradictory results, the present study examined the biological response of the CHO-K1 cell line, whose cells were co-incubated with X irradiated and C-12 ion bombarded samples [10].

Before the radiobiological studies started, the local dose was characterized and dosimetric tests were conducted. The beam dosimetry at HIL is based on single-particle counting, registered by an independent Si-detector system. For the verification of the dosimetry and

homogeneity of the irradiation, studies with the use of physical methods were conducted, including self-developing dosimetry Gafchromic EBT2 films and PM-355 Solid-State Nuclear Track Detectors, as well as biological gamma-H2AX assay.

Quantitative analysis of the results confirmed the proper functioning of the dosimetric system used in the setup. In the dissertation the radiation-induced bystander effect was also analyzed. For this purpose, the biological response of the nonirradiated cells that were cultured with cells irradiated with a C-12 ion beam or X rays was examined (see Figure 8 and Figure 9). In the analysis, two complementary radiobiology tests were used: micronucleus assay and clonogenic assay. The results showed no bystander effect in the experimental system examined.

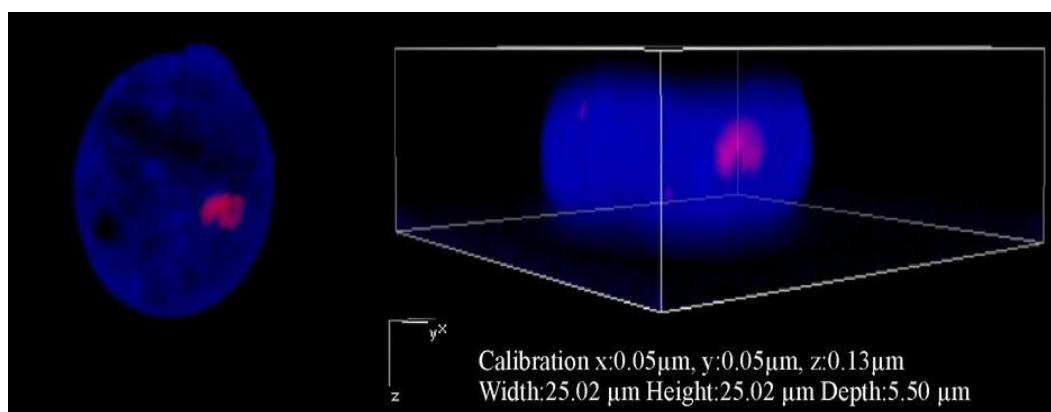

Fig.8 Control cell. [9]

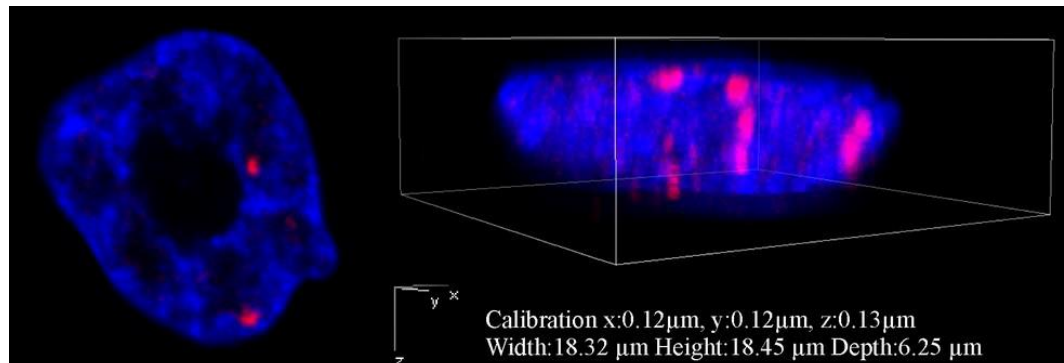

Fig.9 Irradiated cell. [9]

Summarizing the data presented, no evidence of a bystander effect was found in the described experimental setup. These results are different from those obtained in many publications, yet they are not the only ones negating the bystander effect. The reasons for not observing the bystander effect in the described studies are unclear. One hypothetical explanation may be that the CHO-K1 cells did not produce bystander signals, or could not respond to signals sent in our experimental system. It will be necessary to conduct further tests in order clearly to answer this question.

References:

- [1] D.G. Kirsch et al., J. Natl. Cancer Inst. 110(4) (2018) 329.
- [2] T. Konsihi et al., Rev. Sci. Instrum. 76 (2005) 114302.
- [3] J. Bresserer et al., Nucl. Instrum. Methods Phys. B 430 (1999) 154.
- [4] M. Durante, A.A. Friedl, Radiat. Environ. 50 (2011) 335.

- [5] S. Bourret et al., Nucl. Instrum. Methods Phys. B 325 (2014) 27.
- [6] G.A. Drexler et al., Radiat. Oncol. 10 (2015) 42.
- [7] O. Veselov et al., Radiat. Prot. Dosimetry, 122(1-4) (2006) 316.
- [8] J. Czub et al., Radiat. Prot. Dosimetry, 122(1-4) (2006) 207.
- [9] U. Kaźmierczak, Doctoral dissertation, Faculty of Physics, Warsaw (2016).
- [10] U. Kaźmierczak et al. Rep. Pract Oncol Radiother. 19, (2014) S37 – S41.

8.9 Outlook for the production of radioisotopes and radiopharmaceuticals at HIL

J. Choiński

Heavy Ion Laboratory, University of Warsaw, Warszawa, Poland

The Heavy Ion Laboratory (HIL) of the University of Warsaw is currently equipped with the only heavy ion cyclotron in Poland. Of U-200P type, it was constructed in collaboration with Dubna and Polish scientific institutions in the seventies and eighties of the 20th century. This $K_{\max}=160$ isochronous cyclotron allows the acceleration of beams (gaseous and metallic) from $Q/A=1/5$ to $Q/A=1/2$ with energies up to 10 MeV/amu. The experimental infrastructure allows the implementation of a research program at HIL focused not only on nuclear physics, solid state physics, biology and detector testing but also on medical radioisotope production using an alpha particle beam [1]. To extend the possibilities of radioisotope production, the old target station for internal beam irradiation was replaced in 2020 by a new experimental set-up, see Fig.10. This enables us to irradiate solid state targets of metallic Bi with the maximum ${}^4\text{He}^{+1}$ beam current available from the U-200P cyclotron and the future cyclotron. The range of available irradiation radii of the target can vary from 70 cm up to the maximum extraction radius, 85 cm. The system currently consists of a vacuum chamber, a target holder with tilted target, a drive system for the target holder, a drive system for the target station, valves, vacuum meters, a water-cooling system and the main control system. A target can be clamped in the target holder with the help of a remotely controlled drive system. The target holder can be positioned inside the cyclotron valley with the help of the remotely controlled drive system of the target station. The construction of the current version of the target holder with a metallic target should be strong enough to withstand about 500 W. Typically, we use a beam of alpha particles with an energy of about 33 MeV. During a target irradiation among others the beam current is monitored (on-line). Our remotely controlled system is an autonomous system based on a PLC controller.

Realization of the above project is necessary as part of a wider program of production of radiopharmaceuticals containing ${}^{211}\text{At}$, ${}^{44}\text{Sc}$ and ${}^{117\text{m}}\text{Sn}$ isotopes in which HIL is involved. The system allows us to produce not only a single patient dose but multi patient doses of medical radioisotopes.

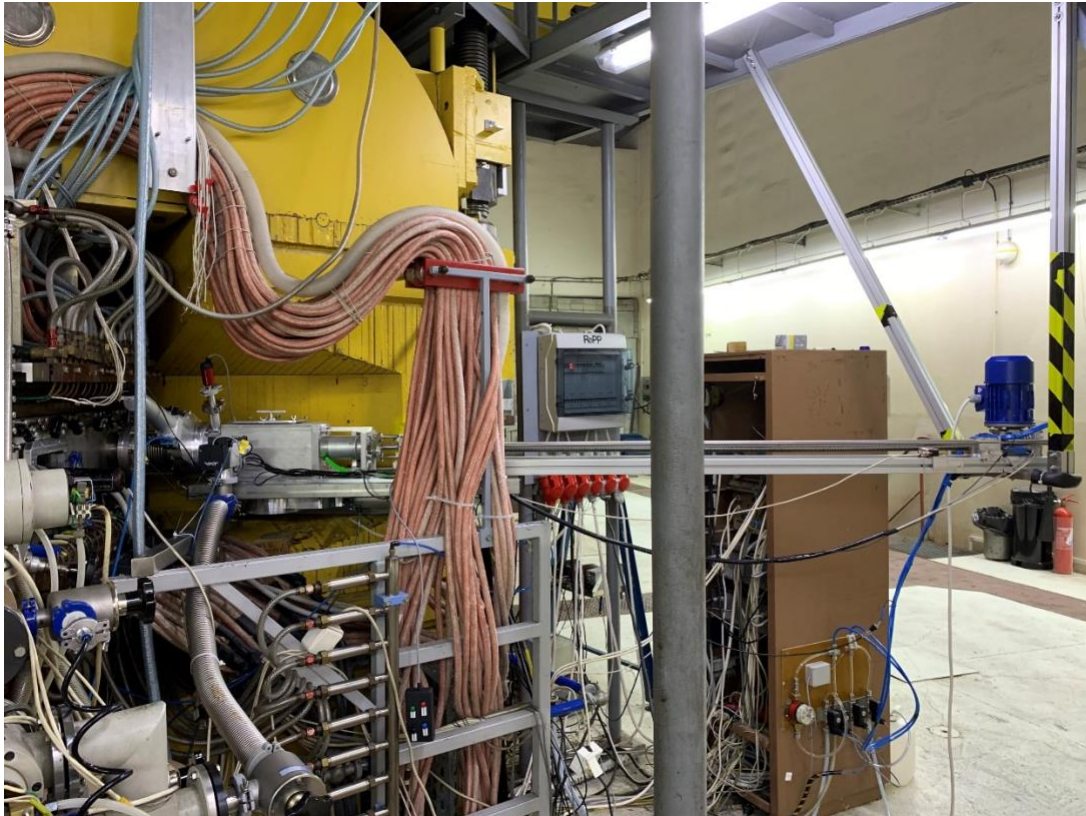

Fig.10 A view of the target station for the U-200P cyclotron.

In 2012 HIL completed the project for a new facility - the Radiopharmaceuticals Production and Research Center (RPRC). This is a fully GMP compliant production facility for radiopharmaceuticals for PET medical technology. It operates a General Electric PETtrace 840 cyclotron and a complete production line of ^{18}F -FDG medicine. The RPRC also has the capability to produce two other isotopes, i.e. ^{11}C , ^{15}O and their associated radiopharmaceuticals [2]. The daily production of FDG has been transferred to a dedicated commercial company. Research activity stays within the HIL domain. The Heavy Ion Laboratory team performs production of other radioisotopes in the intervals between regular production of ^{18}F . To overcome the limitation of available isotopes from the existing PETtrace targets, i.e. ^{11}C , ^{15}O and ^{18}F an external beam line with a target system for solid state targets has been constructed and attached to the cyclotron. This standalone external target system allows irradiation of both metal and powder targets. The target system is connected to the cyclotron via a beam line consisting of: a drift tube of total length 3.4 m, two sets of steering magnets made of permanent magnets, one quadrupole doublet and a four-sector collimator, with shielding provided by a concrete wall of thickness 0.25 m (its specific weight is 3300 kg/m^3). This protective wall improves substantially the safety conditions for the center staff, see Fig. 11. The beam line with the target station has its own autonomous vacuum system which allows a static vacuum of 4×10^{-7} mbar to be reached. The beam transport efficiency to the 12 mm target is greater than 96%. After irradiation the target drops into a lead container and is evacuated from the cyclotron vault on a remotely controlled trolley. This target system is protected by RP patent No 227402.



Fig.11 A view of the standalone external target system.

This has allowed us successfully to execute 2 research projects in the framework of a consortium with financial support from the National Centre for Research and Development, “*Alternative Methods for ^{99m}Tc Production*”, [ALTECH], Agreement No PBS1/A9/2/2012 [3] and “*The development of methods for production of new radiopharmaceuticals based on Sc radionuclides used in positron tomography (PET)*” [PET-SKAND], agreement no PBS3/A9/28/2015 [4] - [8]. We performed more than 100 irradiations of targets for research groups cooperating with us, producing ^{99m}Tc , ^{135}La , ^{43}Sc and ^{44}Sc isotopes.

This system extension of the PETtrace cyclotron will still be used for medical radioisotope production in the future.

Having two cyclotrons accelerating light and heavy ions will enable us to develop new research programs, in particular the use of existing beams for the production of radioisotopes, which may possibly be used as components of new radiopharmaceuticals, mainly for oncological diseases.

References:

- [1] K. Szkliniarz et al., Acta Phys. Pol. A 127, 1471 (2015)
- [2] J. Choiński, Acta Phys. Pol. A 127, 1520 (2015)
- [3] K. Szkliniarz et al., Mod. Phys. Lett. A 32, 1740012 (2017)
- [4] K. Szkliniarz et al., Appl. Radiat. Isot. 118, 182 (2016)
- [5] K. Kilian et al., Molecules 23, 1787 (2018)
- [6] M. Sitarz et al., Appl. Radiat. Isot. 142, 104 (2018)
- [7] R. Walczak et al., J. Radioanal. Nucl. Chem. 322, 249 (2019)
- [8] W. Wojdowska et al., Nucl. Med. Rev. 22, PMID 31482557(2019)

8.10 ENSAR2-Nuclear Physics Innovation and Enterprise Europe Network activity for transfer technology and knowledge between nuclear laboratories and industry

T. Krawczyk

Heavy Ion Laboratory, University of Warsaw, Warszawa, Poland

The purpose of the presentation was to present the activities and experiences of the Nuclear Physics Innovation network and the Enterprise Europe Network for the development of nuclear physics. ENSAR2-Nuclear Physics Innovation and Enterprise Europe Network are organizations working for the transfer of knowledge and innovation between science and industry. These organizations direct their services to a wide range of participants - laboratories, universities, enterprises in such fields as physics, biology, chemistry, electronics, energy, medicine, materials, aeronautics, IT, research equipment and tools. ENSAR2-Nuclear Physics Innovation and Enterprise Europe Network intensify the processes of technology transfer, research and development cooperation, services in areas such as medicine, radiopharmaceuticals, detectors and instrumentation, new instruments, information technologies, radiation, research carried out as part of international cooperation, innovation networks and technology transfer. The most important achievements of the ENSAR2-Nuclear Physics Innovation and Enterprise Europe Network include the organization of the "NUCLEAR PHYSICS RESEARCH - TECHNOLOGY COACTION" workshop and "Nuclear Physics Innovation" brokerage meetings. Both events took place in Warsaw at the Heavy Ion Laboratory of the University of Warsaw on October 11-12, 2018 (see Fig. 12). The companies and scientists participating in the brokerage meeting had the opportunity to present products, services and research achievements during the workshop "NUCLEAR PHYSICS RESEARCH - TECHNOLOGY COACTION". Every scientist or company had 20 minutes for a presentation. The nuclear physics laboratories had the chance to establish links with international industry and SMEs. The goal of the brokerage event was to create a strong network of laboratories and industrial partners in close relation with all the nuclear facilities and partners (better knowledge of existing facilities for industrial beam users, wider markets for technology transfer possibilities). [1]

The main goal of the workshop was to intensify the process of technology transfer, research and development cooperation as well as scientific and innovation activities:

- present the latest scientific achievements in the field of nuclear technologies that can be implemented in industry;
- demonstrate industrial achievements in the field of new devices and tools that can be used in nuclear research;
- identify needs for key nuclear technologies for innovative products, processes and services;
- organize broker meetings to facilitate networking, cooperation and exchange of ideas between research laboratories and companies in the field of nuclear physics;
- discuss the existing sustainability gap and priorities to optimize research and technology efforts;
- discussions were held about challenges and opportunities in new areas of science and industry, and activities to intensify cooperation between laboratories and industry in the area of developing European innovative products, processes and services based on nuclear technologies. [2]



Fig.12 Nuclear Physics Research-Technology Coaction workshop, 11-12 October 2018, Warsaw

The brokerage event explored recent achievements and challenges in the following areas: medicine, radiopharmaceuticals production, detectors and nuclear instrumentation, new space instruments, computation and information technology (Big Data applications, data analysis), energy and environmental technologies, radiation, lasers, numeric machine tools and 3D printing – services, metallurgy, collaborative research, innovation networks and technology transfer [1].

During the workshop 29 presentations were made. They focused on aspects of cooperation between science and industry. Presentations of research institutions were concentrated on the capabilities of available infrastructure and services offered to industry, and scientific presentations on new discoveries that may lead to or require new industrial products. Companies presented new products that may be useful in current research and demonstrated examples of successful cooperation between research institutions and industry.

During the brokerage, 36 bilateral meetings (brokerage meetings) were organized between researchers and companies in which 40 participants took part. The purpose of bilateral meetings was to establish initial contacts that may or may not lead to further research cooperation and to intensify the transfer of innovative technologies.

During the events, 4 enterprises organized an exhibition on applications in the nuclear industry [3].

References:

[1] <https://nupinno.b2match.io/>

[2] <http://slcj.uw.edu.pl/en/blog/2019/11/12/nuclear-physics-research-technology-coaction-2-2/>

[3] M-H. Moscatello, NuPIA workpackage. ENSAR2 Town Meeting. Athens, 11.2020

Author index

P. Bednarczyk	6 , 6.1 , 7.4 , 7.6	P. Magierski	2
G. Benzoni	7.7	A. Maj	1 , 3.3 , 5.2 , 7.4 , 7.5 , 7.6 , 7.7
A. Bilewicz	4.5	N. Marginean	7.3
C. Boiano	7.7	T. Matulewicz	8
A. Bracco	7.7	K. Mazurek	5.2
S. Brambilla	7.7	R. Mikołajczak	8.1
F. Camera	7.7	P. Moskal	8.5
J. Choiński	8.9	P. Napiorkowski	6.6 , 7.4 , 7.5 , 7.6
M. Ciemała	7.4 , 7.5 , 7.6 , 7.7 , 8.7	P. Olko	3.3
N. Cieplicka-Oryńczak	7.7	M. Paluch-Ferszt	8.6 , 8.8
F. Crespi	7.7	P. Pawłowski	7.5 , 7.7
K. Czernski	3.4	J. Perkowski	6.3
I. Dedes	7.2	M. Ploszajczak	2
J. Dudek	7 , 7.1	R. Prokopowicz	3.5 , 8.3
M. Filipek	8.8	K. Pysz	5.6
B. Fornal	7 , 7.3 , 7.4 , 7.6 , 7.7	K. Rusek	1 , 3.2
J. Grębosz	7.5	K.P. Rykaczewski	4.1
E. Grodner	6.5	W. Satuła	2
M. Gryziński	3.5 , 8.3	D. Seweryniak	4.3
Ł.W. Iskra	7.7 , 7.9	J. Skalski	4
Y. Jaganathen	2	R. Skibiński	2
G. Jaworski	6.2	I. Skwira-Chalot	5.5
U. Kaźmierczak	8.6 , 8.8	B. Sowicki	7.5 , 8.7
N. Keeley	5.1	J. Srebrny	6
M. Kicińska-Habior	3 , 7.4 , 7.5	K. Starosta	6.4
St. Kistryn	5	E. Stephan	5
M. Kmiecik	5.2 , 7.4 , 7.5 , 7.6 , 7.7	Z. Szepliński	8.6 , 8.8
A. Korgul	7.8	W.H. Trzaska	8
M. Kowal	4.4	A. Trzcńska	5.4
T. Krawczyk	8.10	S. Upadhaya	5.3
M. Krzysiek	7.4 , 7.6 , 7.7	M. Warda	4.2
Ł. Kurpaska	8.2	B. Wasilewska	7.4 , 7.5 , 7.6 , 7.7
S. Leoni	7.7 , 7.3	G. Wlazłowski	2
M. Lewitowicz	3 , 3.1	A. Wrońska	8.4
J. Łukasik	7.5 , 7.7	K. Wrzosek	6.6
M. Maciak	3.5	M. Ziębliński	7.5 , 7.7 , 8.7

Annex 1. Program of the conference

Monday, January 14, 2019, 8:45-11:00

1. 8:15 – *Registration*
2. **Welcome:** Krzysztof Rusek (Director of HIL), Adam Maj (IFJ PAN) (Chair of Nuclear Physics Section of the PTF) (5')
3. Krzysztof Rusek (HIL) „[History of nuclear physics in Poland](#)”, (15')
4. „**Theory of nuclear structure and dynamics**” (conveners: Wojciech Satuła, Witold Nazarewicz) (120')
 - a. Wojciech Satuła „[Physics of isospin](#)” (15')
 - b. Marek Płoszajczak (GANIL) „[Challenges for theory of atomic nucleus](#)” (25')(abstrakt)
 - c. Yannen Jaganathen (IFJ PAN) „[Gamow Shell Model interaction for p- \(and maybe sd-\) nuclei](#)” (20')(abstrakt)
 - d. Roman Skibiński (UJ) „[Few-body systems and nuclear forces](#)” (20')(abstrakt)
 - e. Piotr Magierski (PW) “[Towards exascale simulations of nuclear dynamics at low energies](#)” (20')(abstrakt)
 - f. Gabriel Wlazłowski (PW) “[Time dependent density functional theory and supercomputing – new prospects for modelling superfluidity in neutron stars](#)” (20')

Coffee break

Monday, January 14, 2019, 11:30-13:30

4. „**Research infrastructures**” (conveners: Marta Kicinska-Habior, Marek Lewitowicz) (120')
 - a. Marek Lewitowicz (GANIL, NuPECC) „[NUPECC Long Range Plan 2017](#)” (20')(abstrakt)
 - b. Krzysztof Rusek (HIL) „[HIL – status and plans for the future](#)” (30')(abstrakt)
 - c. Paweł Olko (IFJ PAN), „[CCB – facility for proton therapy and applications](#)” (15')(abstrakt)
 - d. Adam Maj (IFJ PAN) „[Nuclear Physics at CCB](#)” (15')(abstrakt)
 - e. Michał Gryziński (NCBJ) „[Research reactor MARIA](#)” (15')
 - f. Konrad Czernski (USz) „[Nuclear Physics at Extremely Low Energies: A Small Accelerator System under Ultra High Vacuum Conditions](#)” (20')
5. **Conference photo**

Lunch

Monday, January 14, 2019, 14:30-16:30

6. „**Superheavy elements**” (conveners: Janusz Skalski, Krzysztof Rykaczewski) (120')
 - a. Janusz Skalski „[Superheavy Nuclei at HIL – what could be possible?](#)” (15')(abstrakt)
 - b. Krzysztof Rykaczewski (Oak-Ridge) „[SHE – experimental opportunities for HIL](#)” (25') (skype)(abstrakt)

- c. Michał Warda (UMCS) „[SHE – theoretical perspective](#)” (20’)
- d. Dariusz Seweryniak (ANL) „[Recoil Separators for Studies of Super-Heavy Nuclei](#)” (20’)([abstrakt](#))
- e. Michał Kowal (NCBJ) “[Structure and decays of high-K states in SHN](#)” (20’)
- f. Aleksander Bilewicz (IChTJ) “[Chemistry of superheavy elements](#)” (20’)([abstrakt](#))

Coffee break

Monday, January 14, 2019, 17:00-19:00

- 7. **Mechanisms of nuclear reactions in simple and complex systems (conveners: Stanisław Kistryn, Elżbieta Stephan) (120’)**
 - a. Nicholas Keeley (NCBJ) “[Direct Reactions at Stable Beam Facilities](#)” (20’)([abstrakt](#))
 - b. Katarzyna Mazurek (IFJ PAN) „[Dynamics of fission in phenomenological models](#)” (20’)
 - c. Sahil Upadhyaya (UJ) „[FAZIA – status, perspectives for installation and possible physics case in Poland](#)” (20’)
 - d. Agnieszka Trzcińska (HIL) „[Barriers distribution](#)” (20’)([abstrakt](#))
 - e. Izabela Skwira-Chalot (UW) „[Few-body reactions](#)” (20’)([abstrakt](#))
 - f. Krzysztof Pysz (IFJ PAN) „[Nuclear spallation](#)” (20’)([abstrakt](#))
- 8. *Poster session with refreshments (conveners: Teresa Rząca-Urban, Maria Kmiecik, Józef Andrzejewski) 19:00-21:00*
 - 1. Jan Kisiel, “[Perspektywy wykorzystania laboratoriów podziemnych: projekt BSUIN](#)”
 - 2. Amelia Kosior, “[Shape phase transitions in atomic nuclei along Z = 114 and Z = 120 isotopic chains](#)”
 - 3. Wiktor Parol, “[3-Nucleon Force in Proton Polarized Helium-3 Scattering. Feasibility Studies](#)”
 - 4. Wiktoria Pereira, “[ION TRACKS AND CELLULAR REPAIR MECHANISMS OBSERVED IN RADIATION DOSE RESPONSE CURVES](#)”
 - 5. Katarzyna Rusiecka, “[Investigation of heavy inorganic scintillators for a fiber-based Compton camera](#)”
 - 6. Paweł Sibczyński, “[Application of the pulse-shape discrimination of the PiN type Si detectors in the neutron-rich nuclei investigation](#)”
 - 7. Dominika Wójcik, “[Search for in-medium modifications of properties of strange hadrons](#)”

Tuesday, January 15, 2019, 8:30-11:00

- 9. **„Gamma spectroscopy” (conveners: Julian Srebrny, Piotr Bednarczyk) (140’)**
 - a. Piotr Bednarczyk (IFJ PAN) „[AGATA – status, perspectives for installation in and possible physics case in Poland](#)” (20’)
 - b. Grzegorz Jaworski (HIL) „[NEDA – status, perspectives for installation in Poland and possible physics case](#)” (20’)

- c. Jarosław Perkowski (UŁ) „[Electron spectrometer – status and perspectives](#)” (20’)
- d. Krzysztof Starosta (SFU, Canada) „[Lifetime measurements in inverse geometry](#)” (20’)([abstrakt](#))
- e. Ernest Grodner (NCBJ) „[General outline of research topics feasible in the nearest future at HIL](#)” (20’) (tbc)
- f. Katarzyna Wrzosek-Lipska (HIL) “[Deformations of atomic nuclei studied with Coulomb excitation – perspectives and experimental needs](#)” (15’)([abstrakt](#))
- g. Paweł Napiorkowski (HIL) ” [Coulomb excitations of superheavy nuclei – dreams or research project?](#)” (15’)([abstrakt](#))

Coffee break

Tuesday, January 15, 2019, 11:30-14:10

10. „From isomers to giant resonances” (conveners: Jerzy Dudek, Bogdan Fornal) (160’)

- a. Jerzy Dudek (IPHC Strasburg) „[Complementary Mechanisms in Nuclear Structure: Isomers, Highly excited states and Giant Resonances](#)” (15’)([abstrakt](#))
- b. Bogdan Fornal (IFJ PAN) „[Isomeric states in heavy nuclei – experimental perspectives](#)” (20’)
- c. Michał Ciemala (IFJ PAN) „[PARIS – status, perspectives for installation in Poland and studies of hot rotating nuclei](#)” (20’)([abstrakt](#))
- d. Barbara Wasilewska (IFJ PAN) „[Giant resonances build on cold nuclei](#)” (15’)([abstrakt](#))
- e. Mateusz Krzysiek (IFJ PAN) „[Experimental studies of the strength function below binding energy](#)” (15’)([abstrakt](#))
- f. Natalia Cieplicka-Oryńczak (IFJ PAN) “[Decay of ‘stretched’ states in the continuum](#)” (15’)([abstrakt](#))
- g. Agnieszka Korgul (UW) „[Fast timing beta-delayed gamma spectroscopy](#)” (15’)([abstrakt](#))
- h. Łukasz Iskra (Milano) ““[Decay spectroscopy of the fission products with Gas-Filled Magnet](#)” (15’)([abstrakt](#))
- i. Irene Dedes (UMCS) “[Isomers in exotic nuclei](#)” (15’)([abstrakt](#))
- j. Andrzej Staszczak (UMCS) “[Do nuclei can assume toroidal shapes?](#)” (15’)([abstrakt](#))

Lunch

Tuesday, January 15, 2019, 15:00-18:00

11. Nuclear physics applications (conveners: Tomasz Matulewicz, Władysław Trzaska) (180’)

- a. Renata Mikołajczak (NCBJ) „[CERAD@NCBJ](#)” (20’)
- b. Łukasz Kurpaska (NCBJ) „[Material studies](#)” (20’)([abstrakt](#))
- c. Rafał Prokopowicz (NCBJ) – “[Neutrons in interdisciplinary and nuclear studies](#)” (20’)([abstrakt](#))
- d. Aleksandra Wrońska (UJ) „[Prompt gamma imaging for online monitoring in proton therapy – the SiFi-CC project](#)” (20’)([abstrakt](#))

- e. Monika Paluch-Ferszt (UW) „[How to test electronics used in the Cosmos?](#)” (15’)([abstrakt](#))
- f. Mirosław Ziębliński (IFJ PAN) „[Testing response of detectors with high-energy protons at CCB](#)” (15’)([abstrakt](#))
- g. Paweł Moskal (UJ) “[Application of nuclear physics in studies of discrete symmetries, quantum entanglement and positronium imaging with the J-PET tomograph](#)” (20’)
- h. Urszula Kaźmierczak (HIL) „[Challenges in radiobiology research with heavy ion beam in Poland](#)” (20’)([abstrakt](#))
- i. Jarosław Choiński (HIL) “[Outlook of production of radioisotopes and radiopharmaceuticals at HIL](#)” (15’)([abstrakt](#))
- j. Tomasz Krawczyk (HIL) “[ENSAR2-Nuclear Physics Innovation i Enterprise Europe Network](#)” (10’)

Coffee break

Tuesday, January 15, 2019, 18:15-20:15

- 12. **Summary of the poster session** (T. Rząca-Urban, M. Kmiecik, J. Andrzejewski) (10’)
- 13. **Discussion Panel** (with conveners) (lead by Krzysztof Rusek and Adam Maj) (90’)
- 14. **Summary talk** – Marek Lewitowicz (GANIL, NuPECC) (15’)
- 15. **Closing** – Adam Maj, Krzysztof Rusek, (10’)



ISBN 978-83-959188-0-3