

F. Camera and A. Maj

# **PARIS** White Book



March 2021



# PARIS White Book



PHOTON ARRAY FOR STUDIES WITH RADIOACTIVE ION AND STABLE BEAMS

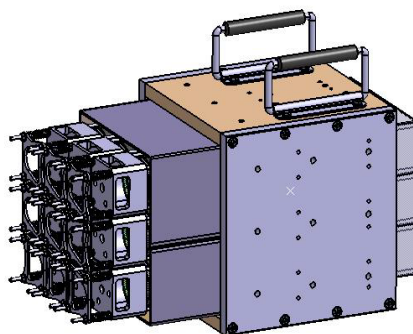

by

F. Camera and A. Maj

March 2021

Published by the Henryk Niewodniczański Institute of Nuclear Physics  
Polish Academy of Sciences  
Kraków 2021

ISBN 978-83-63542-22-1

## Editorial Board

F. Camera (chair), A. Maj (co-chair), S. Leoni, Ch. Schmitt, I. Mazumdar

and

M. Lewitowicz (GANIL), I. Matea, J. Wilson (IPN Orsay),

M. Kmiecik, M. Ciemała (IFJ PAN Kraków),

M. Cinausero (INFN LNL Legnaro), F. Crespi (University and INFN Milano),

V. Nanal, R. Palit (TIFR Mumbai),

J. Gerl (GSI), Yu.E. Penionzhkevich, Yu.G. Sobolev (JINR, Dubna)

## Acknowledgements for the scientific input

P. Bednarczyk, A. Bracco, S. Brambilla, W. Catford, S. Courtin, O. Dorvaux, J. Dudek, S. Erturk, B. Fornal, S. Grevy, J. Grębosz, S. Harissopulos, D. Jenkins, M. Kicińska-Habior, R. Lica, K. Mazurek, P. Napiorkowski, D. Pierroutsakou, M. Stanoiu, O. Stezowski, B. Wasilewska, M. Vandebrouck, J.P. Wieleczko, M. Ziębliński.

Technical Editors:

Franco Camera, Maria Kmiecik  
e-mails: [franco.camera@mi.infn.it](mailto:franco.camera@mi.infn.it),  
[maria.kmiecik@ifj.edu.pl](mailto:maria.kmiecik@ifj.edu.pl)

Cover design:

Jerzy Grębosz

**ISBN 978-83-63542-22-1**

## Contents

PREFACE .....	1
INTRODUCTION.....	2
PARIS CONCEPT .....	2
ELECTRONICS (ANALOGUE VS. DIGITAL) .....	4
TEST EXPERIMENTS .....	7
PARIS MECHANICAL DESIGN.....	10
PARIS PERFORMANCES.....	10
PARIS AT THE GANIL FACILITY.....	13
PARIS AT THE ALTO FACILITY OF THE IJC LABORATORY .....	20
PARIS AT THE CCB FACILITY OF IFJ PAN KRAKÓW .....	26
PARIS AT THE LABORATORI NAZIONALI DI LEGNARO.....	32
PARIS AT THE PELLETRON LINAC FACILITY, MUMBAI.....	41
PARIS AT THE FAIR/GSI FACILITY.....	44
PARIS AT JINR .....	49
THE PATH TOWARDS A PARIS MINICUBE .....	54
SUMMARY.....	62
REFERENCES.....	63





## Preface

PARIS is a collaborative international project to construct and operate a novel gamma-ray calorimeter, which profits wholly or in part from employment of novel, advanced scintillator materials, such as Lanthanum Bromide, and which should have performances superior to any other existing scintillator calorimeter.

The intention of the PARIS project is to enhance the Physics program of the hosting laboratory. In fact, PARIS is eminently portable and could be used at different international facilities using both stable or radioactive beams. More details can be found on the PARIS web page <http://paris.ifj.edu.pl>.

The present report, the PARIS White Book, is intended to provide a general description of the performances of the PARIS array, of the different laboratories which could, in the next years, host it and of the physics cases that can be addressed by the PARIS array.

The presented physics cases are obviously not exhaustive. They simply give some examples where the physical information, provided by the PARIS array, is understood to be the key point for the success of the measurement. As the physics cases will also depend on the detector arrays which will be coupled to PARIS in the future years, and on the beams (stable or radioactive) provided by the hosting laboratory, this list of possible experiments is expected to increase with the years.

The White Book is structured in sections. The very first section, labelled 'Introduction' provides the basic performances of the PARIS phoswiches and PARIS clusters, along with some selected results of the tests which have been performed so far. The following seven sections are dedicated to the different laboratories where the PARIS array could be located in the future years and briefly discuss the mechanical setup and electronics required. For some of the laboratories, the first experimental results obtained with PARIS are also discussed. As the physics cases depend on the hosting laboratory, in these laboratory sections the different physics cases which could be addressed by the PARIS array are also presented.

At the moment, the considered physics cases assume that the PARIS array covers a solid angle between  $1\pi$  and  $2\pi$  only, depending on the used geometry and on the distance from the target. New physics cases, requiring the highest efficiency, larger solid angle or larger granularity could be considered in the future, if PARIS is successfully augmented to cover larger solid angle or reach a compact  $4\pi$  geometry. This is discussed in the chapter after those associated to the different laboratories. In the very last chapter there is a short summary of this White Book.

It is the intention of this White Book to support the collaboration and help to decide on the future PARIS campaigns, as well as on its promising enhancement to  $4\pi$ .

## Introduction

In the measurement of gamma radiation, the best detector should have excellent energy and time resolution, good full energy peak efficiency and no internal radiation. Obviously, such a detector does not exist. The best energy resolution is provided, at the moment, by HPGe detectors but the cost, the maintenance and the performances in terms of time resolution are far from being ideal. In addition, the intrinsic full energy peak efficiency for high-energy gamma rays ( $5 \text{ MeV} < E_\gamma < 30 \text{ MeV}$ ) is quite low and, at the moment, large volume single HPGe crystals (e.g. vol.  $> 1$  liter) are not commercially available.

In the past decades, the measurements of high-energy gamma rays were done using arrays of scintillator detectors as for example (in the 80') the Oak Ridge Spin Spectrometer [[Jaa83](#)], the Darmstadt Crystal Ball [[Met83](#)] or the French Chateau de Crystal [[Bec84](#)]. In the 90' the Milano-Copenhagen-Krakow collaboration built the Hector array (based on large volume BaF<sub>2</sub> detectors [[Maj94](#)]) and, more recently, the Milano group built the Hector+ array (based on large volume LaBr<sub>3</sub>:Ce detectors [[Gia13](#)]). Also, large volume NaI detectors (several liters volume) have been used for the measurement of high-energy gamma rays [[New81](#)] in the last decades. In this case, a high intrinsic full energy peak efficiency and good time resolution was preferred at the expense of energy resolution.

Even though in the last years there has been quite a large development in new materials for the measurement of radiation, the 'ideal' gamma detector does not exist yet. A feasible solution consists in the design of a detector making use of a combination of different scintillator materials in a phoswich geometry. In this way, one can benefit from the different 'features' of the different scintillator materials constituting the phoswich.

## PARIS concept

PARIS (Photon Array for studies with Radioactive Ion and Stable beams) is an international research project with the aim of developing and building a novel  $4\pi$  gamma-ray calorimeter, benefiting from recent advances in scintillator technology. It is intended to play the role of an energy-spin spectrometer, a calorimeter for high-energy photons and a medium-resolution gamma-detector. The device is composed of two shells: the scintillators of the most advanced technology (LaBr<sub>3</sub>:Ce or CeBr<sub>3</sub>) for the inner volume offering simultaneously high efficiency, excellent time resolution and relatively good energy resolution in a large energy range, and a more conventional scintillator (NaI) for the outer shell. The array can be used in a stand-alone mode, in conjunction with other detection systems, like germanium arrays (e.g., AGATA, EXOGAM, ...), particle detectors (e.g., MUGAST, NEDA, FAZIA, ACTAR) or heavy-ion spectrometers (e.g., VAMOS, PRISMA). It will be used in experiments with both intense stable and radioactive ion beams to study the structure of atomic nuclei and new nuclear excitation modes as a function of angular momentum, isospin, and temperature, as well as reaction dynamics.

The international partners of the PARIS project are IN2P3 and GANIL (France), COPIN Consortium (Poland), INFN (Italy), TIFR/BARC/VECC (India), IFIN HH (Romania), University of Surrey, University of York (U.K.), Nigde University, Sebahattin Zaim University, Istanbul Technical University, Akdeniz University (Turkey), JINR Dubna (Russia) and GSI/FAIR (Germany).

The PARIS project draws on a wide section of the nuclear physics community with a broad range of physics interests. The primary goals of PARIS are the following studies:

- the properties of hot rotating exotic nuclei produced in fusion-evaporation reactions by means of the gamma-decay of the GDR;
- new modes of excitation, e.g. Pygmy Dipole Resonances or near barrier resonances;
- the nuclear reaction dynamics;
- the shell-structure of light-mass nuclei.

PARIS is composed of “phoswich” detectors: a frontal part 2”×2”×2” composed by LaBr<sub>3</sub>:Ce/CeBr<sub>3</sub> scintillators coupled to a 2”×2”×6” NaI scintillator. Both scintillators being read with a common photomultiplier. The detectors can be arranged in clusters of 9 phoswiches each, which allows different geometries of the whole array (see Fig. 1). The energy deposited in one phoswich is obtained by off-line add-back procedure of the energies deposited in both parts of the phoswich, while the energy deposited in the whole cluster is obtained by summing the energy depositions in each phoswich.

The construction of the PARIS array is carried out in four phases: Phase 1) a cluster of 9 phoswich detectors (finalized in 2012); Phase 2) PARIS demonstrator: 8 clusters (end of 2021); Phase 3) 2 $\pi$  array (12 clusters); Phase 4) an ultimate 4 $\pi$  PARIS calorimeter with 24 clusters. Presently, phase 2 is realized, the decision when to realize the next phases will be taken in the short future by the PARIS Collaboration and relies on the continuous scientific and financial involvement of the interested parties.

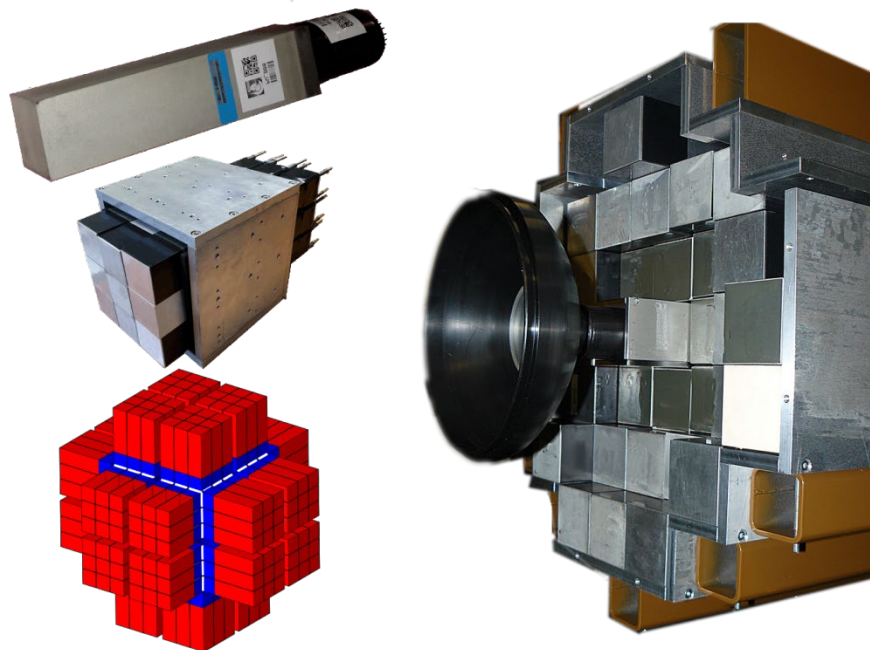

**Figure 1. Left column, from top to bottom: PARIS phoswich, a cluster, a 4 $\pi$  cube of 24 clusters. Right: Wall geometry (33 phoswiches).**

The very crucial feature of the PARIS array is its efficiency, which obviously depends on the detectors size and on the solid angle covered by the detectors. Figure 2 shows a comparison of the full absorption efficiency dependence on the gamma-ray energy for two phases of PARIS, “PARIS Demonstrator” with 8 clusters (ca. 1/3 of 4 $\pi$  solid angle) and “PARIS 4 $\pi$ ” with 24 clusters.

Another characteristic property of the PARIS array is its high granularity, allowing for the measurement of gamma-rays multiplicity (FOLD). Example of total deposited gamma-ray energy versus FOLD (H-K) matrices presented below (see Fig. 3), is based on the simulations of the fusion-fission reaction of <sup>238</sup>U, at beam energy of 6.2 MeV per nucleon on a <sup>9</sup>Be target.

A substantial improvement in the H-K matrix measurement is observed when using a  $4\pi$  geometry instead of the 8 cluster geometry; this is due to the improved efficiency and granularity in the  $4\pi$  configuration.

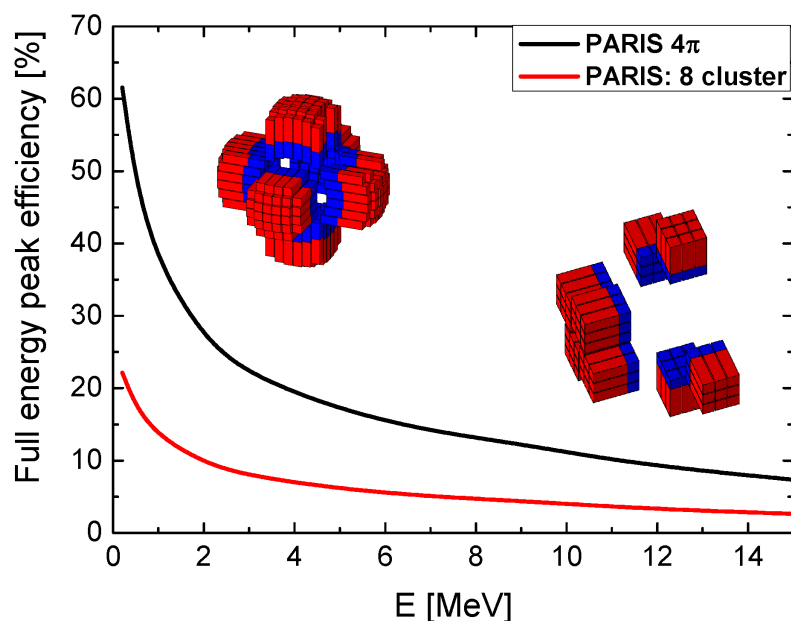

Figure 2. Comparison of full energy peak efficiencies of 72 phoswich (8 cluster) to  $4\pi$  PARIS geometry, with distance between emitter and detectors of 25 cm.

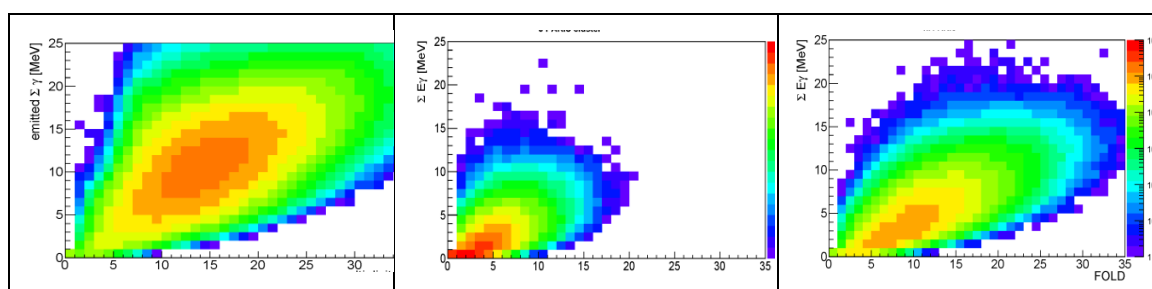

Figure 3. The left panel presents gamma-ray sum-energy versus gamma-ray multiplicity, used in the event generator. Resulting sum energy of gamma rays deposited in PARIS versus FOLD for: 8 cluster geometry (middle panel) and  $4\pi$  geometry (right panel).

### Electronics (analogue vs. digital)

The PARIS array is designed to detect in beam gamma radiation at very high counting rate (several tens kHz in a single detector) and in a broad energy range (from about 1 MeV up to 50 MeV). A phoswich detector, the basic element of the PARIS array, provides a complex signal consisting of overlapping fast  $\text{LaBr}_3:\text{Ce}$  and slow  $\text{NaI}$  components. However, pulse shape analysis (PSA) guarantees that a good gamma-ray energy resolution and precise timing can still be maintained. At the final stage of the PARIS project, the data acquisition (DAQ) will be required to deal with hundreds of such channels at high acquisition rate. These conditions constrain the PARIS electronics to a digital, trigger-less system capable of independent readout of each detector channel and to perform PSA algorithms online. Time stamping will be used to synchronize detectors contributing to the same physical event. PARIS will cooperate with other 'detectors' array, as for example the AGATA gamma-ray spectrometer and ancillary detectors. Therefore,

the PARIS DAQ must be compatible with the Global Trigger and Synchronization (GTS) standard, used for example by AGATA and already implemented at GANIL or LNL.

To develop a dedicated algorithm for data processing the response of a phoswich detector was investigated in a broad gamma-ray energy range of roughly 0.5-20 MeV, with radioactive sources and in-beam measurements. The right part of Fig. 4 shows the phoswich pulses related to the crystal type where the energy was released (i.e. in  $\text{LaBr}_3\text{:Ce}$  only, in NaI only, or in both). This can be fully resolved using two-dimensional analysis by integrating signals during a short  $\sim 150$  ns ( $Q_S$ ) and a long  $\sim 1 \mu\text{s}$  ( $Q_L$ ) time gates. An example of a plot of  $Q_S$  versus  $Q_L$  is shown in Fig. 4.

The two well separated components (semi-diagonals) correspond to the  $\text{LaBr}_3\text{:Ce}$  and NaI events, the related signal shapes are also shown. Such simple pulse shape algorithm can be used for the offline add-back procedure, in which the energies released in  $\text{LaBr}_3\text{:Ce}$  and NaI are summed.

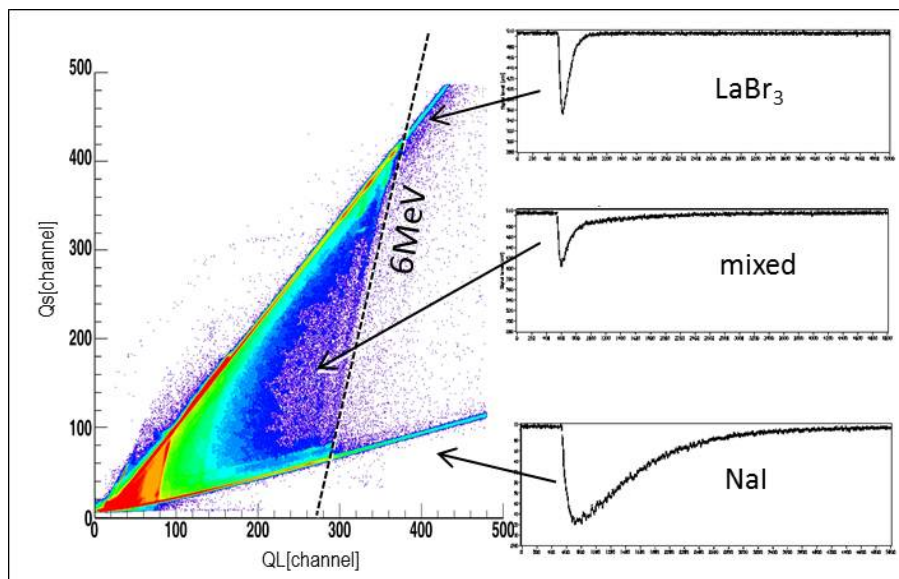

**Figure 4.** Left: a  $Q_S$  vs  $Q_L$  plot for a phoswich detector, obtained for a 6 MeV gamma source using the PARISPRO card. The steep diagonal strip representing the fast pure  $\text{LaBr}_3\text{:Ce}$  signals is well separated from the less steep diagonal strip related to much slower NaI pulses, while mixed events are seen in between. Right: shapes of the corresponding signals [Zie20].

This PSA technique was implemented in the PARIS dedicated analogue electronics module named PARISPRO, constructed by INFN Milano and used in the early phase of the PARIS spectrometer. PARISPRO is a 16 channel NIM module, it delivers two shaped signals proportional to the total gamma-ray energy deposited in the detector (SLOW) and to the amplitude of the  $\text{LaBr}_3\text{:Ce}$  component (FAST), respectively, and the time signal from CFD. These three output signals are further processed by two peak sensing ADCs (SLOW, FAST) and a TDC, which are set in a VME crate and read out throughout the Kmax DAQ. This system was successfully applied in a series of PARIS standalone tests but also in the experiment performed at GANIL, where PARIS detectors were combined with the AGATA gamma-ray spectrometer and the VAMOS mass separator. In this case, the readout of the PARIS VME boards was synchronized with the AGATA digital DAQ using the AGAVA interface, in a similar way as the VAMOS particle detectors. An alternative approach to PARISPRO can be applied if one integrates charges in more than one gate using a digitizer. It allows to distinguish easily between energy deposits in  $\text{LaBr}_3\text{:Ce}/\text{CeBr}_3$  and NaI parts by the ratio between collected charges in the short ( $Q_S$ ) and total ( $Q_L$ ) gates as:  $(Q_L - Q_S)/Q_L$  (see Fig. 5). For example, the V1730 digitizer board from CAEN has demonstrated excellent overall performance as regards slow and fast component discrimination, timing precision and readout bandwidth. This

VME based 16 channels board is equipped with 500 MHz, 14 bit FADC and DPP-PSD (Digital Pulse Processing for Charge Integration and Pulse Shape Discrimination) firmware allowing on-line pulse processing and digital CFD. Data can be readout through VME bus, USB or an optical link for faster transmission. An example of clear separation of LaBr<sub>3</sub>:Ce and NaI signals of a phoswich detector irradiated by combined radioactive sources of <sup>137</sup>Cs and <sup>60</sup>Co is shown in Fig. 5. Moreover, a coincident measurement of <sup>60</sup>Co transitions by two detectors revealed a time resolution of about 700 ps (FWHM). The measurement showed that V1730 allows to acquire data at rates as high as 20 kHz per channel, without noticeable dead-time.

The V1730 digitizers were used to acquire data in-beam during experiments with PARIS detectors at IFJ PAN, Kraków and TIFR Mumbai. Synchronization of a setup based on CAEN V1730 digitizers with the AGATA-like GTS clock distribution system is currently tested at INFN Milano and LNL.

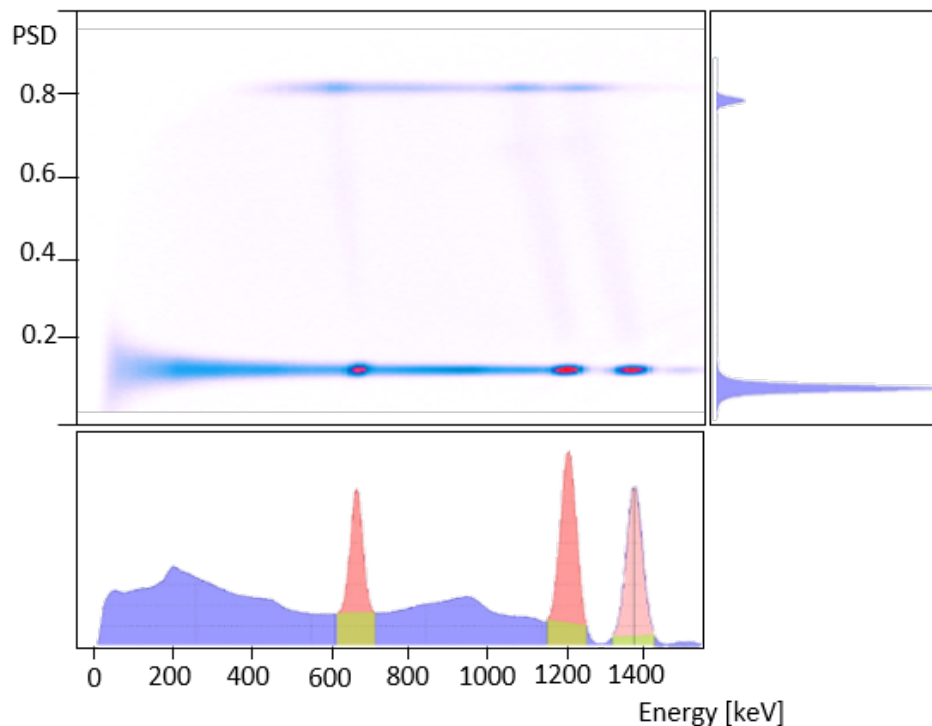

Figure 5. Fast-Slow signal separation obtained from the DPP-PSD firmware by CAEN, the resulted PSD value is defined as  $(Q_L - Q_S)/Q_L$ , where  $Q_L$  is long gate (1  $\mu$ s) and  $Q_S$  is short gate (150 ns). Right upper panel: PSD values for all of the energies; events with values of around 0.8 are associated to an NaI only energy deposition, those around 0.15 are associated to a LaBr<sub>3</sub>:Ce/CeBr<sub>3</sub> only energy deposition and the mixed events are between them. Left upper panel: summed PSD values. Bottom panel: summed energy spectrum of combined <sup>137</sup>Cs, <sup>60</sup>Co sources [Tin20].

An alternative digitizer based DAQ was used mainly in experiments with PARIS at the ALTO installation of IJCLab, Orsay. The FASTER DAQ used for PARIS, developed by LPC Caen (<http://faster.in2p3.fr/>), is based on 500 MHz, 12-bit CARAS digitizers. Each CARAS digitizer card can code 2 phoswiches, providing for each phoswich a short and a long integrated charge, plus a time stamp. PSA equivalent to the one presented in Fig. 5 can be obtained and the overall performances are equivalent to the ones obtained with V1730 CAEN digitizers. In experiments performed at ALTO, up to 36 phoswiches were used.



## Test experiments

As previously discussed a single unit of PARIS is a “phoswich” composed of a frontal part (2”×2”×2” LaBr<sub>3</sub>:Ce or CeBr<sub>3</sub>) and a longer NaI scintillator (2”×2”×6”). The phoswiches based on LaBr<sub>3</sub>:Ce were available some times before those based on CeBr<sub>3</sub>, therefore two tests using high-energy gamma rays were performed; one in 2013 and the second, four years later. Between these two measurements one test using fast neutrons produced by the Licorne facility at ALTO was performed.

The first test of a PARIS cluster was performed in 2013 at the Bremsstrahlung facility **ELBE** of Helmholtz-Zentrum Dresden-Rossendorf in Dresden, Germany. It employed the Nuclear Resonance Fluorescence phenomenon. The continuous-energy gamma-ray beam, with the energies reaching 15 MeV, was used to irradiate a <sup>11</sup>B target. The de-exciting nucleus emitted well-separated gamma rays. The highest observed transition was the 8.917 MeV line from the <sup>11</sup>B( $\gamma, \gamma'$ ) reaction.

The PARIS cluster was positioned at a distance of 30 cm and at 125° angle with respect to the beam direction. The detectors were shielded from low-energy gamma rays with lead bricks of 5 cm thickness. Two high purity germanium (HPGe) detectors, used for monitoring, were placed at 127° at a distance of 42 cm (see Fig. 6). Signals from the detectors were processed by dedicated analogue electronic modules.

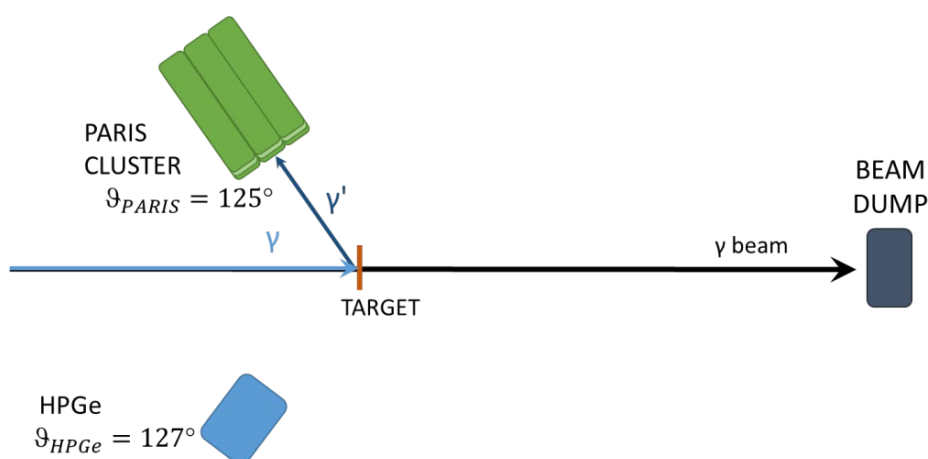

Figure 6. Scheme of the set-up used at the Bremsstrahlung facility ELBE of Helmholtz-Zentrum Dresden-Rossendorf [Was20a].

The experiment allowed to prepare and test the data analysis. The main focus was on the development of the algorithms used to recover the information about the full-energy deposition inside one cluster. These procedures were named *internal* and *external add-back*, for the recovery within one phoswich and one cluster, respectively (see Fig. 7). Quantitative results from this test could not be provided, as the large dead-time and a substantial flux of 511 keV gamma rays from electron-positron annihilation made the obtained efficiency values highly uncertain.

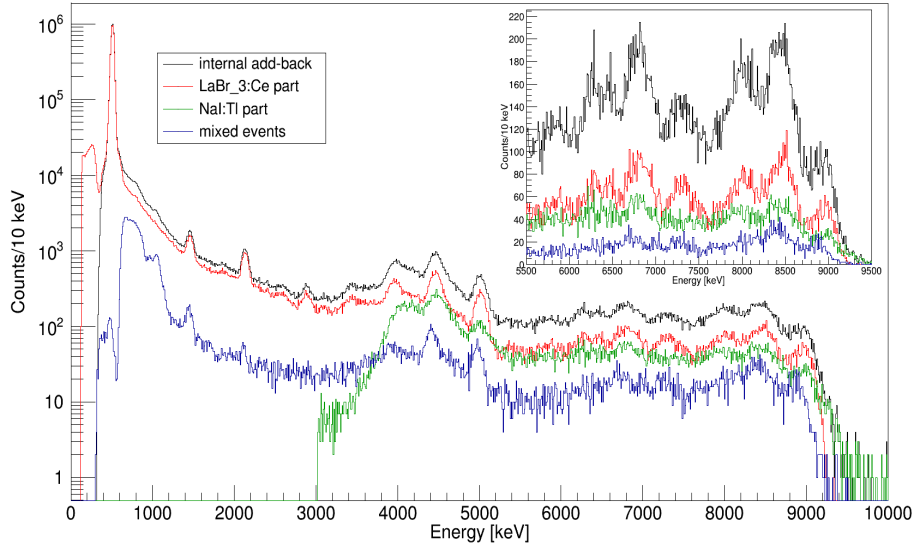

Figure 7. Illustration of the effect of the add-back on one PARIS phoswich (internal add-back). A spectrum after the internal add-back procedure (black line) and spectra gated on specific kind of events - full energy deposition in LaBr<sub>3</sub>:Ce (red line), full energy deposition in NaI:Tl (green line) or mixed event (blue line) are presented. In the inset, the high-energy part of the spectra is shown [Was20a].

A set of tests experiment were also carried out in TIFR Mumbai, India. The PARIS LaBr<sub>3</sub>:Ce+NaI:Tl phoswiches response was investigated for gamma-ray energies between 0.6 MeV up to 22.6 MeV. High energy gamma-rays were obtained with the use of <sup>11</sup>B(p,γ) reaction. For the highest gamma-ray energy of 22.6 MeV the FWHM/E was equal to 2.1% [Gos16].

The following test of a PARIS cluster took place in 2017 at the **ATOMKI** institute in **Debrecen**, Hungary. In this experiment, the resonant radiative proton capture resonance was used. In total, five resonant reactions on three different targets were utilized, enabling the characterization of the PARIS cluster in the energy range between 1 and 18 MeV.

The PARIS cluster used in this test was constituted by the two types of phoswiches: the LaBr<sub>3</sub>:Ce+NaI:Tl detectors, and a newer configuration of CeBr<sub>3</sub>+NaI:Tl ones. This measurement was, in fact, a first attempt to characterize phoswiches of the latter type. The cluster was positioned at 15 cm from the target, at 57° with respect to the beam direction. HPGe detector, used as the efficiency reference, was placed symmetrically to the cluster (see Fig. 8).

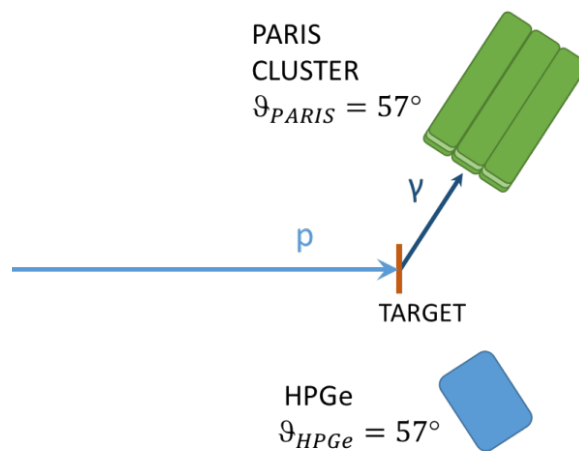

Figure 8. Scheme of the experimental set-up at ATOMKI institute in Debrecen [Was20a].



One of the reactions employed in the test was the  ${}^7\text{Li}(p, \gamma)$  resonant capture, in which gamma rays of 17.6 MeV are produced (see Fig. 9). Because well-defined high-energy gamma rays are hard to obtain elsewhere, more measurements of this reaction were taken. Aside from a standard  $3 \times 3$  cluster configuration, additional data for, so-called,  $\mu$ Clusters of four detectors were collected as well. Two  $\mu$ Clusters were built, one composed of  $\text{LaBr}_3\text{:Ce+Nal:TI}$  phoswiches only, the other of  $\text{CeBr}_3\text{+Nal:TI}$  detectors. For all three configurations, the reaction was measured at two distances rather than one: at 15 and 30 cm from the target.

The collected data are of high quality and have a low, discernible, background. After the currently on-going evaluation process, they will become reference points for the future usage of the PARIS clusters.

An experiment was also performed at **IPN Orsay** with the use of **LICORNE** fast neutrons, which were generated in the inverse kinematics reaction:  $\text{H}({}^{11}\text{B}, {}^{11}\text{C})\text{n}$ . The detection setup was composed from one PARIS cluster (9  $\text{LaBr}_3\text{:Nal}$  type phoswiches) and one EDEN neutron detector, both placed symmetrically around zero degree at 0.9 m distances from the hydrogen target. The hydrogen target was 2.5 cm thick at a pressure of 1.15 bars. The Hydrogen gas flow was set at  $1 \text{ cm}^3/\text{sec}$ . The beam was passing through a  $2.5 \mu\text{m}$  thick Ta window before arriving in the gas. Analog electronic was used. Signals from detectors (PARIS and EDEN) were treated by the PARISPRO NIM module, whose "FAST" and "SLOW" outputs were inputs for VME ADC module, while its CFD output (OR) validated by pulsing of the  ${}^{11}\text{Be}$  beam was used, after delay, as common STOP for TDC module, which was started by each detector separately. Using  $\text{LaBr}_3\text{:Ce}$  timing we measured the Time of Flight (see Fig. 10a), which allows to obtain neutron energy spectrum as presented in Fig. 10b.

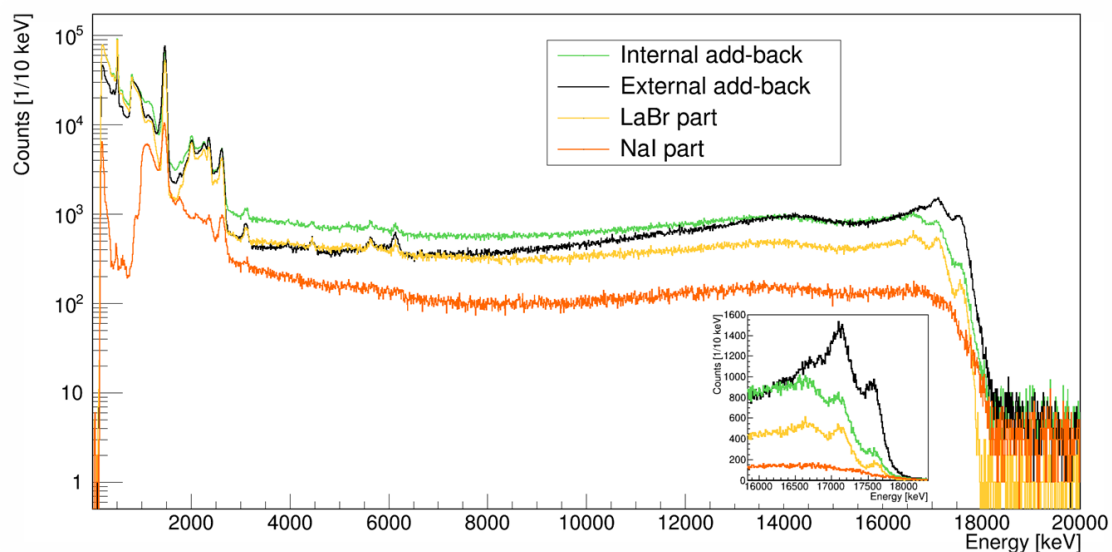
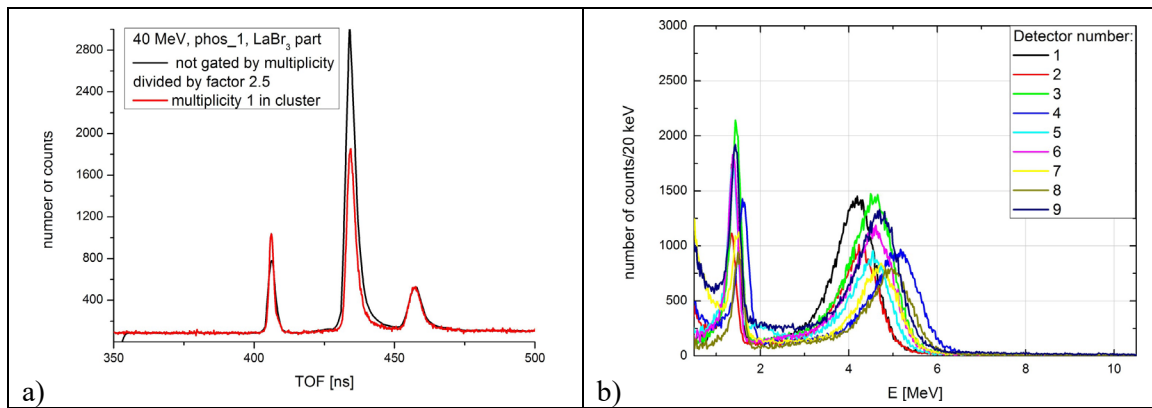

Figure 9. The spectra of the  ${}^7\text{Li}(p, \gamma)$  reaction collected with one PARIS cluster. The spectra after the internal add-back (green line) and external add-back (black line) procedures are presented. The events of full energy deposit in  $\text{LaBr}_3\text{:Ce}$  (yellow line) and  $\text{Nal:TI}$  (orange line) are also shown (adapted from [Was18]).



**Figure 10.** Left: TOF spectrum for one PARIS phoswich with FOLD equal one condition, in comparison to un-gated data. The three peaks correspond to prompt gamma peak (from  $^{11}\text{B}$  excited state 2.1 MeV), fast and slow neutrons, respectively. Right: Neutron energy spectrum for nine PARIS phoswiches obtained for  $^{11}\text{B}$   $E_{\text{beam}} = 40$  MeV and distance of 0.89 m between target and detector.

## PARIS mechanical design

As stated before, the basic piece of PARIS is the phoswich, fabricated by Saint Gobain (when  $\text{LaBr}_3:\text{Ce}$  based) and Scionix (when  $\text{CeBr}_3$  based). The two crystals of the phoswich are enveloped in an aluminum cap of 0.5 or 1 mm thickness, depending on the design version, with a quartz window on the NaI side in order to collect the light from the crystals. A mechanical piece (see left panel of Fig. 11) was designed to match the cylindrical PMT to the square transverse section of the phoswich and this piece is currently mounted by default on the phoswich by Saint Gobain. Its role is also to ensure the optical contact between the quartz window and the PMT and to mount the phoswiches in a cluster configuration as in the middle panel of Fig. 11.

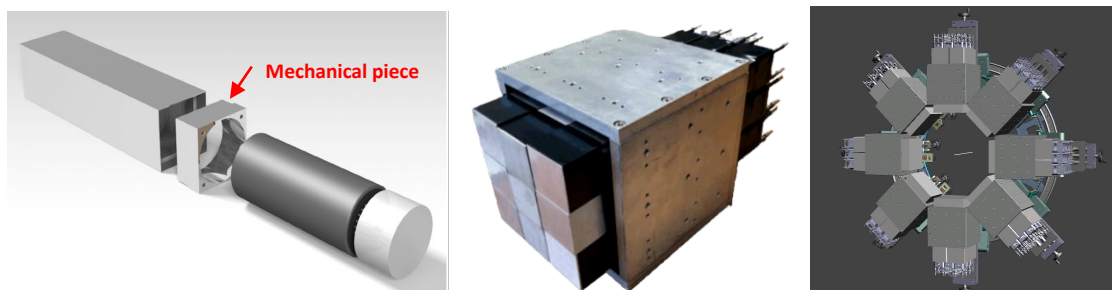

**Figure 11.** The mechanical assembly of a PARIS phoswich (left panel), a PARIS cluster (middle panel) and a PARIS ring where 8 PARIS clusters can be positioned (right panel).

The PARIS collaboration designed and manufactured also a mechanical frame to hold up to 8 PARIS clusters, see the right panel of Fig. 11 (the distance to target is about 22 cm). This frame can be used in a full circle configuration or in quarters of circle (with up to 2 clusters per quarter). The clusters carriages can slide to change the polar angle and a change of  $\pm 10^\circ$  in azimuthal angle can be made. The mechanical frame can be attached using NORCAN profiles in an experimental setup.

## PARIS Performances

The base for testing the basic properties of the PARIS detectors is located at the IPHC Strasbourg. A dedicated bench test has been developed to test all PARIS detectors in the same way, coupled to a R7723-100 Hamamatsu PM tube used as a reference. The energy resolution protocol is based

on applying a stable high voltage in a way to have a 60 mV signal for the 662 keV gamma line of a  $^{137}\text{Cs}$  source placed on the front face of the detector. This gives the guarantee to have an appropriated large energy range for the PARIS physics cases maintaining the best possible energy and sub-nanosecond timing resolutions After testing, all the basic properties for each PARIS phoswich detector are stored in the on-line data base, accessible by the PARIS collaboration.

To obtain optimized results, a tapered configuration of a dedicated voltage divider has been proposed by Hamamatsu and then realized at the IPHC Strasbourg. A new PCB has been developed and to ensure the best possible optical coupling, a mechanical design for the cluster configuration has been developed by the IPN Orsay. The obtained linearity has been tested and remains excellent up to 22 MeV gamma-ray energy [Gos16].

A mechanical work has been undertaken to adapt a PARIS phoswich detector to the AGATA scanning table at IPHC Strasbourg. This gave the opportunity to characterize the non-homogeneity of response inside the crystals, mainly in the NaI part. As an example, the Fig. 12 shows the typical phoswich scanning results for the area under the peak, the energy resolution and the position of the centroid for the 662 keV gamma line.

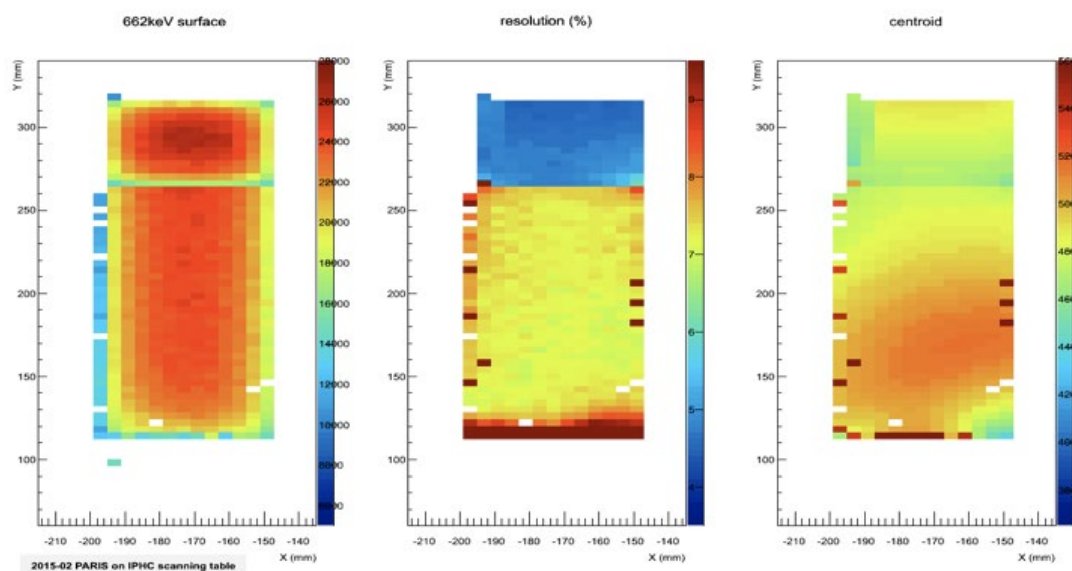

Figure 12. Results for a phoswich scanning using the AGATA scanning table at IPHC Strasbourg.

Since PARIS detectors might be used close to high magnetic fields like spectrometers, a cluster shield has been designed and tested at the target position close to the VAMOS spectrometer. As can be seen in Fig. 13, the effect of the magnetic field influenced very little the performance of the PARIS detectors in a cluster configuration [Bou17].

The PARIS array, at different phases of its realization, has been used so far in GANIL (coupled to the AGATA germanium array), ALTO-Orsay (standalone, with Licorne and coupled to the  $\nu$ -ball germanium array and other detectors), in ATOMKI Debrecen, in Rossendorf, at the CCB facility of the IFJ PAN Krakow (coupled to the KRATTA charged particle array and 4 large  $\text{LaBr}_3:\text{Ce}$  detectors) and in Mumbai.

The experimental energy resolution for the PARIS clusters is presented in Fig. 13, together with the simulations which take into account the addback between  $\text{LaBr}_3:\text{Ce}/\text{CeBr}_3$  and NaI in each phoswich, as well as the addback of all 9 phoswiches in the cluster. The grey shaded area shows the simulated energy resolution for the cluster, assuming the  $\text{CeBr}_3/\text{LaBr}_3:\text{Ce}$  parts to have a FWHM/E in the range of 4.5 – 5 % at 662 keV, and the NaI parts to have FWHM/E in the range

of 6.7-7.5% at 662 keV. Experimental data taken with the  $\text{CeBr}_3$  phoswich type cluster are indicated by stars;  $\text{LaBr}_3:\text{Ce}$  phoswich type by squares, cluster made from both types by triangles.

Data marked in green are taken with the magnetic field of VAMOS at GANIL; those indicated in orange were obtained for the emission from ions moving with beta around 10 % of speed of light and detectors being in the VAMOS magnetic field on; those in black are from a source measurement at CCB and those in dark blue are from test measurements at ATOMKI, with the use of  $(p, \gamma)$  reactions.

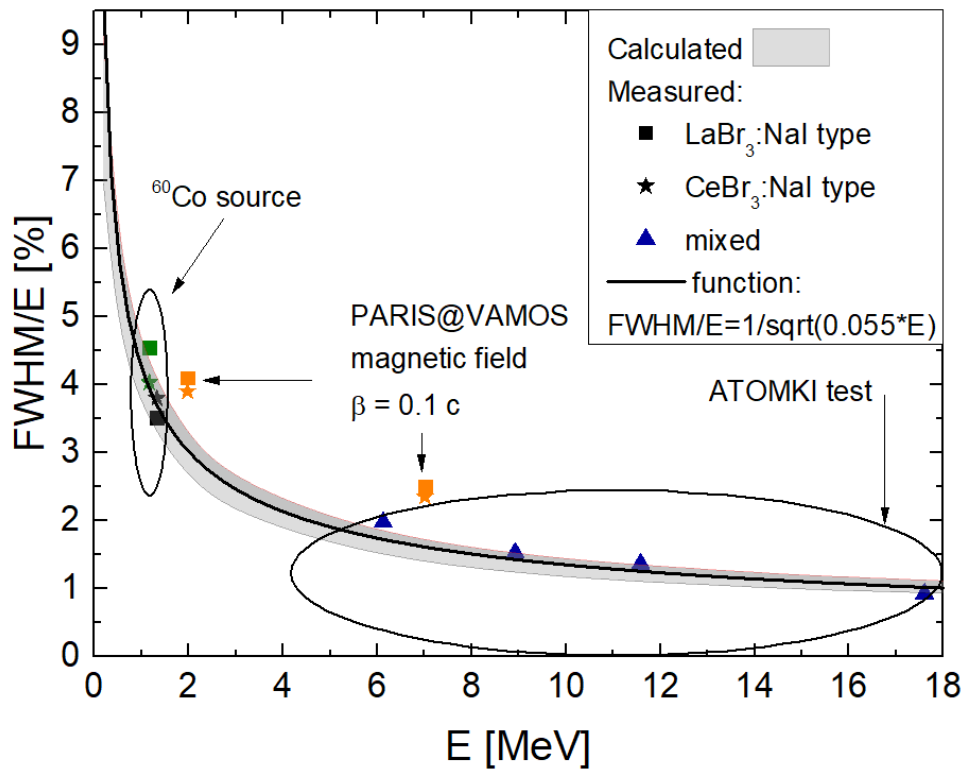

Figure 13. PARIS cluster energy resolution as a function of gamma-ray energy: simulation and experimental results. The continuum line indicates the  $1/\sqrt{E}$  energy dependence of the FWHM.

## PARIS at the GANIL facility

M. Lewitowicz<sup>1)</sup>, M. Ciemafa<sup>2)</sup>, R. Lica<sup>3)</sup>, M. Vandebrouck<sup>4)</sup>, S. Grevy<sup>5)</sup>, Ch. Schmitt<sup>6)</sup>

<sup>1)</sup> GANIL, CEA/DRF-CNRS/IN2P3, Bvd Henri Becquerel, 14076 Caen, France

<sup>2)</sup> Institute of Nuclear Physics, PAN, 31-342 Kraków, Poland

<sup>3)</sup> "Horia Hulubei" National Institute of Physics and Nuclear Engineering, Bucharest, Romania

<sup>4)</sup> Irfu, CEA, Université Paris-Saclay, F-91191 Gif-sur-Yvette, France

<sup>5)</sup> UMR 5797, CNRS/IN2P3, Université de Bordeaux, Chemin du Solarium, 33175 Gradignan Cedex, France

<sup>6)</sup> Institut Pluridisciplinaire Hubert Curien, F-67037 Strasbourg, France

### Main Collaborating institutions:

GANIL, IN2P3/CNRS labs, Irfu Saclay, IFIN-HH, IFJ PAN Kraków and the PARIS collaboration

### The GANIL facility and available beams



Figure 14. View of the GANIL Facility.

The GANIL-SPIRAL2 facility is one of the largest and leading laboratories in the world engaged in research with ion beams with the main focus of the lab being fundamental nuclear physics. This is supplemented by strong programs in accelerator based atomic physics, condensed matter, radiobiology and industrial applications. The intensity and variety of beams delivered by the cyclotrons and by the superconducting linear accelerator and the associated state-of-the-art scientific instruments make GANIL-SPIRAL2 an unique and outstanding multi-disciplinary facility. GANIL is one of the premiere European heavy-ion beam research institutes and strongly contributes to the radiance of European Science. The construction of SPIRAL2, ESFRI roadmap landmark facility, was approved by the French government in 2005.

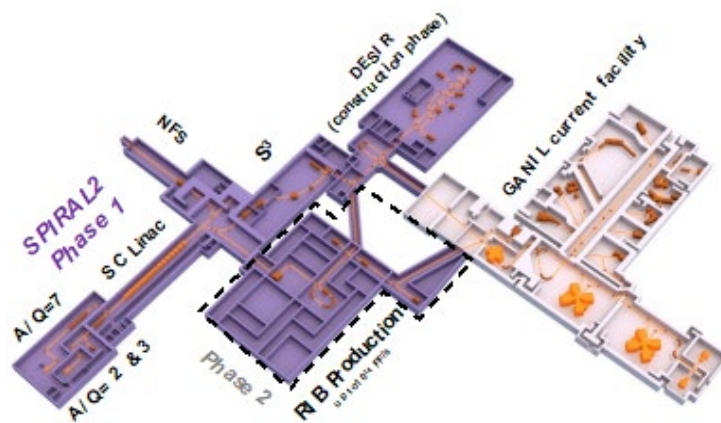

Figure 15. Layout of the current GANIL facility, including the extension for SPIRAL2 Phase 1.

to further increase their intensity. The super-conducting LINAC is currently being commissioned and the first experiments at NFS are foreseen in 2020-2021.

The construction of SPIRAL2 Phase 1 (fully funded) consists of the state-of-art LINAC, the Neutrons For Science (NFS) and the Super-Separator Spectrometer (S<sup>3</sup>) experimental facilities. Another experimental facility DESIR (Désintégration Excitation et Stockage d'Ions Radioactifs) for low-energy Rare Isotopic beams is also under construction. A new injector, for the LINAC, will allow to expand the variety of beams (up to uranium) and to



The construction of SPIRAL2 phase 1 is accompanied by a vigorous science program and associated technical developments by international users for the full exploitation of this unique facility. In particular, new user communities have been created for the dedicated scientific instrumentations as Neutrons For Science (NFS), Super Separator Spectrometer (S3), and DESIR. The facility has also attracted a number of arrays of new detectors NEDA (NEutron Detector Array), PARIS (Photon Array for studies with Radioactive Ion and Stable beams), ACTAR-TPC (ACTIVE TARGet detector), MUGAST, INDRA-FAZIA and AGATA, which have been funded, installed and actively used by international collaborations.

### *The cyclotron complex*

The GANIL cyclotrons complex consists of five cyclotrons and hundreds of meters of beamline. Each year, it delivers more than 4000 hours of beam-time for nuclear physics and astrophysics, atomic physics, material sciences, radiobiology. Several experiments can be running in parallel.

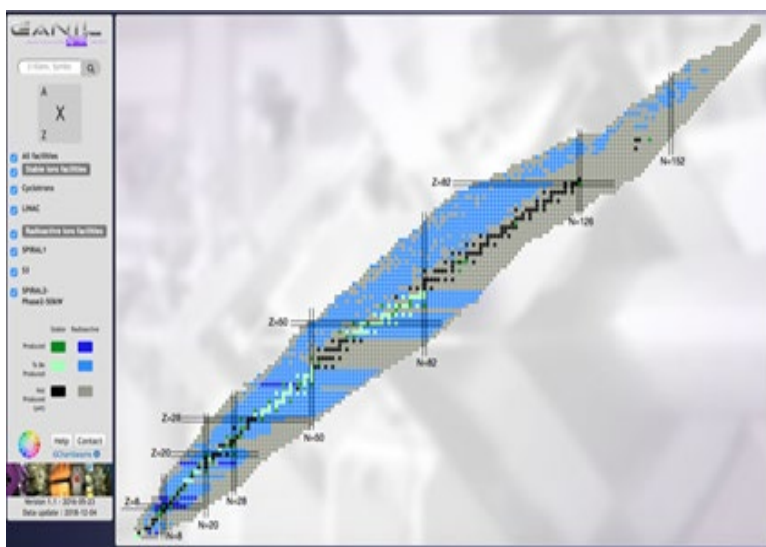

Figure 16. The interactive chart of beams at GANIL.

Five cyclotrons are on site to offer a large range of beam energies:

- 2 compact cyclotrons (C01 and C02): Beam energy < 1 MeV/A
- 2 separated sector cyclotrons (CSS1 and CSS2): 13.5 MeV/A < Beam energies < 100 MeV/A
- 1 compact cyclotron SPIRAL1 for radioactive beams: Beam energy < 25 MeV/A

### *The SPIRAL2 Superconducting Linear Accelerator*

SPIRAL2 is a new facility which will open new horizons to research at GANIL. The SPIRAL2 LINAC (LINEar ACcelerator) can accelerate lighter nuclei (protons, deuterons, helium) than the GANIL cyclotrons, thereby extending the research done until now.

The linear accelerator is made of 26 accelerating cavities, enclosed in 19 cryomodules. It is composed of niobium and cooled by liquid helium. The main beam characteristics of the LINAC beams are:

- energy ranges: 33 MeV for protons, 40 MeV for deuterons, < 14.5 MeV/A for heavy ions,
- intensities: up to 5 mA for protons and deuterons, < 1 mA for heavier ions.

Full characteristics of stable-ion and radioactive-ion beams delivered and expected at the GANIL-SPIRAL2 facility can be searched for through an interactive chart of beams at: <https://u.ganil-spiral2.eu/chartbeams/> (see Fig. 16).

## The use of PARIS at GANIL

In 2017, the array was used in the AGATA campaign at GANIL. In this framework one experiment was performed using PARIS and the first results of this experiment were published recently in *M. Ciemała et al., Phys. Rev. C101, 021303(R) (2020)*. There is currently one experiment accepted by the GANIL PAC with the PARIS array, by R. Lica et al., which is planned to be performed in 2021. Two other experiments were accepted for the ongoing AGATA campaign at GANIL, but not performed (one by P. Bednarczyk, A. Maj et al. and the other by B. Fornal, S. Leoni et al.). In addition, two Letters of Intent proposing a use of the PARIS array were submitted to the GANIL PAC in September 2020. There are also other ideas of using PARIS coupled to the VAMOS spectrometer for fission studies, with the INDRA-FAZIA multidetector for studies of reactions at intermediate energies and for Super Heavy (SHE) studies at S3.

### Electronics

In 2017, 18 PARIS phoswich detectors (2 clusters) were coupled to the AGATA gamma array and VAMOS spectrometer at GANIL. PARIS analogue electronics was consisting of Milano designed PARISPRO module responsible for amplification and producing CFD signals together with CAEN ADC V879 and TDC V878 modules coupled to the GANIL data system as a branch of the VAMOS electronics. This allowed to couple the PARIS data system to the high-performance setup with AGATA digitizers via the Krakow designed AGAVA interface.

Following recommendations of the PARIS electronics working group, the future experiments with PARIS at GANIL will use digital electronics most probably based on the CAEN V1730 digitizers. The required coupling of the electronics to the GANIL data acquisition system will be taken in charge by the GANIL electronics and DAQ service with participation of the PARIS collaboration.

### Mechanics

The mechanics to couple 18 PARIS phoswich detectors to the AGATA structure already exists and it is based on the EXOGAM frame. Elements holding PARIS clusters in the frame were made by IFJ PAN Krakow and designed by STFC Daresbury Laboratory.

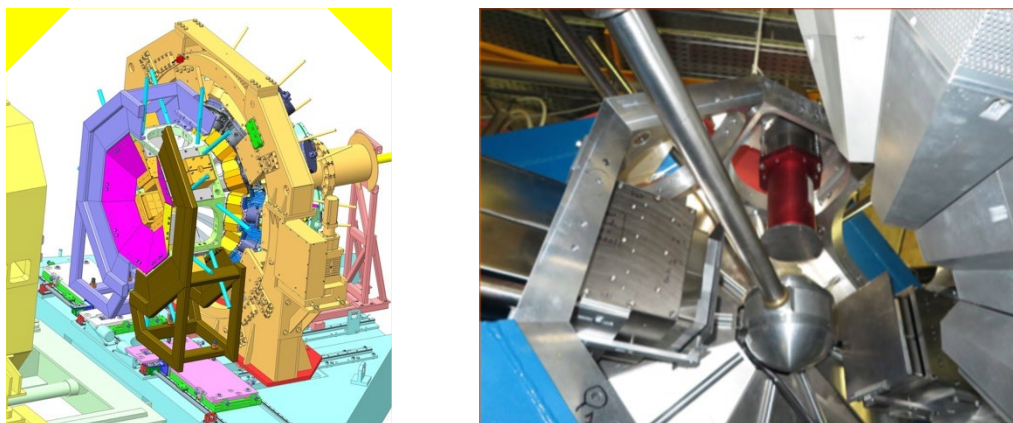

**Figure 17. AGATA-PARIS setup at GANIL (2017 campaign).**

New mechanical systems adapted to the setups and environment of experimental halls at LISE, VAMOS and NFS which will be able to host up to 8 PARIS clusters will be constructed and used in the forthcoming experiments. The mechanical coupling of PARIS will be studied by GANIL and the PARIS collaboration.

## Physics Cases

The present list of physics cases is not-exhaustive and is just a sample of what could be done with PARIS in the few coming years at the GANIL-SPIRAL2 facility:

1. Lifetimes in A=18 region measured with PARIS - *S. Leoni, B. Fornal, M. Ciemala et al.*
2. Study of deformed and spherical  $2^+$  states via Coulomb excitation and first-time measurement of PDR in  $^{34}\text{Si}$  - *R. Lica - O. Sorlin et al.*
3. PDR measurements with PARIS at NFS - *M. Vandebrouck et al.*
4. Coulomb excitation of Oxygen, S and Si isotopes (LISE-ACTAR-EXOAM2-PARIS) - *S. Grevy, O. Sorlin et al.*
5. Insight into fission from prompt  $\gamma$ -rays with PARIS@VAMOS at GANIL - *Ch. Schmitt, et al.*

### 1. Lifetimes in A=18 region measured with PARIS

To test the predictive power of *ab initio* nuclear structure theory, the lifetime of the second  $2^+$  state in neutron- rich  $^{20}\text{O}$ ,  $\tau(2^+) = 150^{+80}_{-30}$  fs, and an estimate for the lifetime of the second  $2^+$  state in  $^{16}\text{C}$  have been obtained for the first time in a recent experiment were PARIS, AGATA and VAMOS have been coupled together [Cie20]. The results were achieved via a novel Monte Carlo technique that allowed us to measure nuclear state lifetimes in the tens-to-hundreds of femtoseconds range by analyzing the Doppler-shifted  $\gamma$ -transition line shapes of products of low-energy transfer and deep-inelastic processes in the reaction  $^{18}\text{O}$  (7.0 MeV/u) +  $^{181}\text{Ta}$ . The requested sensitivity could

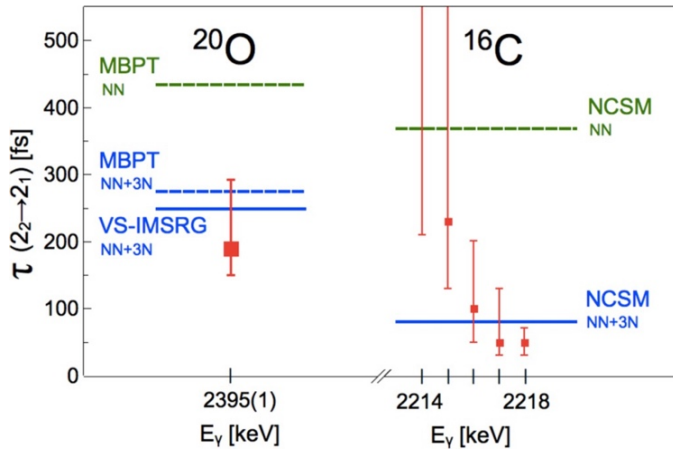

**Figure 18.** Partial lifetime of the second  $2^+$  state in  $^{20}\text{O}$  and  $^{16}\text{C}$ , as measured with the AGATA+PARIS+VAMOS setup, in comparison with theory predictions considering two-body (NN) and two-body plus three-body (NN+3N) terms of the nuclear interaction [Cie20].

only be reached owing to the excellent performances of the Advanced gamma-Tracking Array AGATA, coupled to the PARIS scintillator array and to the VAMOS++ magnetic spectrometer. The experimental lifetimes agree with predictions of *ab initio* calculations using two- and three-nucleon interactions, obtained with the valence-space in-medium similarity renormalization group for  $^{20}\text{O}$  and with the no-core shell model for  $^{16}\text{C}$ . The present measurement shows the power of electromagnetic observables, determined with high-precision gamma spectroscopy, to assess the quality of first-principles nuclear structure calculations, complementing common benchmarks

based on nuclear energies. This pioneering experiment demonstrated the relevance of our novel experimental approach, and we propose to further exploit it with the augmented PARIS array. The proposed approach will in particular be essential for short lifetime measurements in unexplored regions of the nuclear chart, including *r*-process nuclei, when intense beams, produced by Isotope Separation On-Line (ISOL) techniques, become available.



## 2. Study of deformed and spherical $2^+$ states via Coulomb excitation and first-time measurement of Pygmy Dipole Resonance in $^{34}\text{Si}$

Due to its closed-shell  $Z=14$ ,  $N=20$  character,  $^{34}\text{Si}$  has the properties of a doubly-magic spherical nucleus, but lies at the edge of the 'Island of Inversion', where nuclei are deformed in their ground state configuration. It follows that deformed configurations and shape coexistence are present already among the few first excited states in  $^{34}\text{Si}$ . The structure of  $^{34}\text{Si}$  was recently studied through gamma spectroscopy separately in the beta-decays of  $^{34}\text{Mg}$  and  $^{34}\text{Al}$  at the ISOLDE facility of CERN. Spectroscopic properties of  $^{34}\text{Si}$  have been investigated and were compared with shell-model calculations using the SDPF-U-MIX interaction in order to describe the underlying structure of  $^{34}\text{Si}$ , specifically regarding the level of mixing between normal and intruder configurations for the  $0_1^+$  and  $0_2^+$  states. The previously known reduced transition probability in  $^{34}\text{Si}$ ,  $B(E2; 0_1^+ \rightarrow 2_1^+) = 85(33) e^2\text{fm}^4$  is affected by a large uncertainty which hinders the interpretation of the configuration mixing. A Coulomb excitation measurement has been proposed at GANIL, in order to measure the  $B(E2; 0_1^+ \rightarrow 2_1^+)$  together with the  $B(E2)$  associated with the transition towards the other  $2_3^+$  state which is expected to be spherical. The latter has been estimated using shell-model calculations as  $B(E2; 0_1^+ \rightarrow 2_3^+) = 110 e^2\text{fm}^4$ . The results obtained through the Coulomb excitation measurement of  $^{34}\text{Si}$  will represent a valuable input for large scale shell-

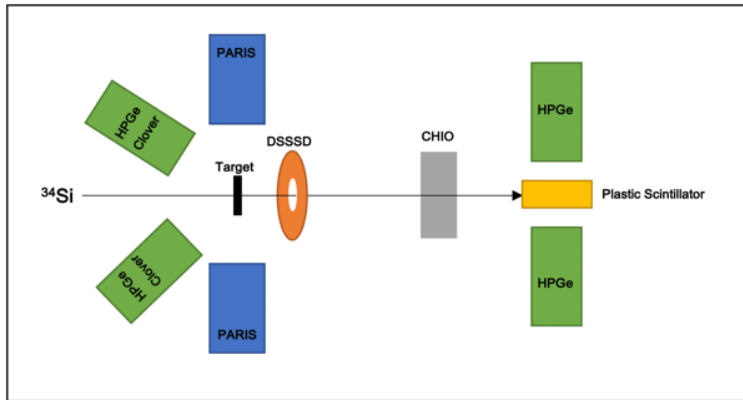

Figure 19. Schematic view of the experimental setup requested for the  $^{34}\text{Si}$  experiment.

model calculations using the SDPF-U-MIX interaction, which is able to treat higher order intruder configurations. The second goal of this experiment will be the measurement, for the first time, of the Pygmy Dipole Resonance (PDR) in  $^{34}\text{Si}$ . Theoretical calculations using the subtracted second random-phase approximation (SSRPA) to describe microscopically the transition strength find that these low-lying PDR states in  $^{34}\text{Si}$  are just above of the neutron separation energy and the isovector ( $B(E1)$  value) and the isoscalar components of the PDR can be measured using two probes: isovector ( $^{208}\text{Pb}$  target) and isoscalar ( $^{12}\text{C}$  target). The isoscalar probe will have an essential role in determining also the nuclear contributions in the Coulomb excitation of the low energy states, while the isovector can offer access to the  $B(E1)$  and  $B(E2)$  values. Radioactive beams of 50 AMeV delivered by the LISE fragment separator are particularly well suited to probe the low-energy structure, as well as the pygmy dipole mode in  $^{34}\text{Si}$ . The aim is to study these quantities in a single experiment, using the PARIS array to detect the gamma rays originating from the de-excitation of the  $2^+$  states and of the  $1^-$  states generating the PDR.

## 3. Pygmy Dipole Resonance measurements with PARIS at NFS

A letter of intent has been submitted to the GANIL PAC proposing the use of a new probe, namely the  $(n, n'\gamma)$  reaction at NFS, to characterize the fine structure of the Pygmy Dipole Resonance (PDR). Neutrons, in addition to be a pure nuclear probe (no electromagnetic interaction simultaneously), will offer the possibility to address the PDR complex-structure problem with a new approach, complementary to the usual study which consists in the comparison of the so-called isoscalar vs. isovector excitations. Indeed, it is well established that for hadron scattering at energies of the order of a few tens of MeV per nucleon, the proton-neutron interaction is three times larger than that between alike nucleons. Thus, as proton scattering mainly probes neutron

components of a transition, neutron scattering is sensitive to protons in the nucleus. Using the  $(n, n'\gamma)$  probe at NFS could reveal the nature of the PDR at the nucleus surface and highlight the role of protons in the PDR excitation. The obtained results will be compared to the ones obtained using proton (as well as alpha and heavy-ion) inelastic scattering.

#### 4. Coulomb excitation of O, S and Si isotopes (LISE-ACTAR-EXOGRAM2-PARIS)

The study of the O chain is very interesting and challenging for theoretical models as there are many structural evolutions induced by the gradual filling of neutrons states that possibly leads to several doubly-magic nuclei at each neutron shell closure. Indeed, the filling of the  $p_{3/2}$ ,  $p_{1/2}$ ,  $d_{5/2}$  and  $s_{1/2}$  leads to  $N=6, 8, 14$  and  $16$  gaps, respectively, associated to the  $^{14}\text{O}$ ,  $^{16}\text{O}$ ,  $^{22}\text{O}$  and  $^{24}\text{O}$  nuclei.

Magicity implies that the  $2^+$  energy is high, while the probability to excite it,  $B(E2)$ , is lower than in the neighbouring nuclei. Measuring  $B(E2)$ 's therefore brings more stringent structural information than the sole  $2^+$  energy value. In particular, contrary to the case of deformed nuclei where the  $B(E2)$  is simply related to the  $2^+$  energy, the  $B(E2)$  in the oxygen chain varies in a more unexpected manner. For example,  $^{16}\text{O}$  has the highest  $2^+$  energy but has the largest  $B(E2)$  value so far observed in the Oxygen chain. This *a priori* surprising feature comes from the fact that the  $B(E2)$  value scales with the square of the nucleon's effective charge. The  $B(E2)$  is the lowest when the composition of the wave function of the  $2^+$  is mainly of neutron origin, as in  $^{20}\text{O}$ . The neutrons carry about three times less effective charge than protons and thus a factor of about 9 less to the  $B(E2)$  value. The  $2^+_{11}$  state of the self-conjugate  $^{16}\text{O}$ , likely carries 2p2h excitations from protons and neutrons as well as from 1p1h proton-neutron excitations. Measuring  $B(E2)$  in  $^{14}\text{O}$  (unknown) and in  $^{22}\text{O}$  (poorly known) will help in determining the role of protons and neutrons in the excitation, especially when combined with  $(p,p')$  measurement.

An experiment has been proposed at LISE, aiming at a dedicated measurement of the  $B(E2)$  values in the  $^{22}\text{O}$  and  $^{14}\text{O}$  nuclei with the ACTAR-EXOGRAM-PARIS setup. The proton inelastic scattering in the ACTAR-TPC will be measured in order to determine, when combined with the  $B(E2)$  values, the respective proton to neutron ( $M_p/M_n$ ) contributions to the  $2^+$  state.

#### 5. Insight into fission from prompt gamma rays with PARIS@VAMOS at GANIL

The present project is intended to promote an experimental campaign with PARIS@VAMOS to study various aspects of nuclear fission, related to fundamental structural and dynamical properties of nuclei. The strategy relies on the measurement of the prompt decay by gamma emission of the mass- ( $A$ ) and charge- ( $Z$ ) tagged fragments over a wide range of photon energy. Independent on the interest in the line-shape itself of the gamma spectrum, the mean photon multiplicity ( $M_\gamma$ ) and total energy released by radiation ( $E_\gamma^{\text{tot}}$ ) will be derived, which quantities can be related to the so-called entry point in excitation energy and angular momentum. Combining the performance of the VAMOS spectrometer and the specificities of the new-generation PARIS array, with the assets of the uranium beam from GANIL, offers definite advantages.

The present project proposes to couple the PARIS array with the VAMOS spectrometer at GANIL. The PARIS cells, arranged in clusters and consisting of new-generation  $\text{LaBr}_3:\text{Ce}/\text{CeBr}_3 + \text{NaI}$  phoswiches, will permit to measure the Prompt fission Gamma-ray Spectra (PFGS) over a wide  $E_\gamma$  range, including the discrete gamma lines and statistical decays at low and high photon energy, respectively. The  $\text{LaBr}_3:\text{Ce}/\text{CeBr}_3$  section is best suited for measuring the low energy structures with sufficient resolution, while the phoswich concept provides high efficiency for most energetic photons. Furthermore, neutrons can be efficiently discriminated. In addition to its shape, the average properties of the PFGS in terms of  $M_\gamma$  and  $E_\gamma^{\text{tot}}$  will be extracted. The fragment emitter will be identified uniquely in mass and charge, and its velocity vector required for Doppler correcting the gamma spectrum will be determined, by the VAMOS spectrometer which

performance for fission is well established. The high-quality  $^{238}\text{U}$  beam available at GANIL at barrier energies will permit to run in inverse kinematics. Besides the assets of reverse kinematics for fragment identification, it will allow to measure efficiently, and in exactly the same conditions, different fissioning systems by “simple” change of the target, minimizing at the same time the influence of systematic errors. According to the variation of the fragment population in  $(A, Z)$  with fissioning system, insight into the fragment at the origin of a specific structure or bump in the PFGS will be obtained.

As for “flagship” experiments to start with and address the aforementioned aspects, fusion-induced fission is considered, from  $^{238}\text{U}+^9\text{Be}$ ,  $^{238}\text{U}+^{12}\text{C}$  and  $^{238}\text{U}+^{26}\text{Mg}$  collisions with typical beam energies of 6 MeV/nucleon. Further extensions of the set-up like the implementation of a second detection arm (*e.g.* for total kinetic energy information) or coupling with the SPIDER telescope are foreseen in a second stage, depending mainly on the performance of the set up in terms of  $\gamma$  efficiency. They will permit to enlarge the physics case to the evolution of fission properties with excitation energy, as well as to quasi-fission like mechanisms.

The combination of PARIS and VAMOS at the GANIL facility constitutes a unique opportunity worldwide to gain new insight into the physics around PFGS. Regarding the time line, the baseline of the set up consists of VAMOS and PARIS with highest efficiency (minimum of 8 clusters required); the latter is crucial for the significance of the physics outcome of the measurements, namely by extending the spectrum up to highest energy, on one side, and applying multiple and tight fragment  $A$  and  $Z$  gates, on the other side. The installation of an extended PARIS at VAMOS will require the previously used mechanics and electronics to be augmented. Altogether, a physics campaign could be feasible from beginning of 2022 on.

# PARIS at the ALTO facility of the IJC Laboratory

*J.N. Wilson and I. Matea*

*IJC Laboratory, Université Paris-Saclay, CNRS/IN2P3 (France)*

## Main Collaborating institutions:

IFJ PAN Kraków, INFN Milano, JINR Dubna, JRC-Geel and the PARIS collaboration

## The ALTO facility and available beams

The ALTO facility is a facility dedicated principally to fundamental and applied research in nuclear physics. It is located in building 109 on the campus of the Université de Paris Saclay and is the largest platform of the newly created IJC Laboratory. ALTO consists of two principal accelerators, a 50 MeV electron Linear Accelerator and a 15 MV tandem accelerator.

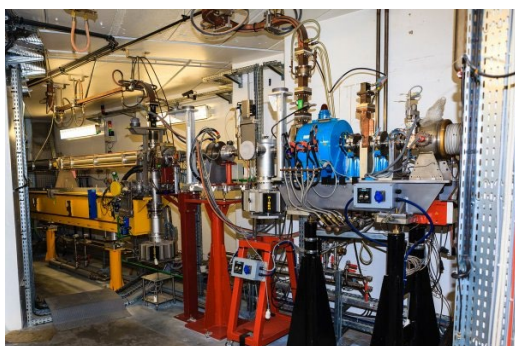

The electron Linac (see Fig. 20, top) is dedicated to the production of exotic neutron-rich nuclei via the Isotope Separation OnLine (ISOL) technique. Uniquely ALTO uses the photofission of Uranium Carbide (UCx) targets as the production mechanism of these nuclei. The neutron-rich fission fragments produced by photofission are ionized and then accelerated as low energy beams (LEB) at 30 kV to be transported, mass selected, and sent to experimental setups in the observation hall.



**Figure 20. Pictures of the electron linac and of the Tandem accelerator (bottom) at the ALTO facility of the IJC Laboratory.**

The Tandem accelerator (see Fig. 20, bottom) is a large electrostatic machine that can run at voltages of up to 15 MV and can accelerate a wide range of stable heavy-ion beams from protons up to heavy nuclei such as  $^{127}\text{I}$  with high intensities. These beams can be used to induce a wide range of nuclear reactions with the goal of subsequent study of the reaction products. The Tandem accelerator also has an excellent beam pulsing/chopper system with a 100 ns – 100  $\mu\text{s}$  period range and 1.5 ns time resolution, very useful for studying the decay properties of nuclear states. Finally, the high intensities of  $^7\text{Li}$  beams available from the Tandem are exploited to produce high flux, naturally directional secondary neutron beams with the unique LICORNE inverse kinematics neutron source in an energy range of 0.5 – 4 MeV.

ALTO typically delivers around 3000 hours of beam time per year to perform a wide variety of experiments proposed by local, national and international users. Details on available beams, energies and intensities can be found at the ALTO website: <http://ipnwww.in2p3.fr/Installation-ALTO,5>

ALTO typically delivers around 3000 hours of beam time per year to perform a wide variety of experiments proposed by local, national and international users. Details on available beams, energies and intensities can be found at the ALTO website: <http://ipnwww.in2p3.fr/Installation-ALTO,5>

## The use of PARIS at ALTO

During the period since 2016, while PARIS has been in its initial development phase, one cluster of phoswich detectors has been available for tests and experiments at ALTO. Several in-beam

experiments have been performed addressing the following subjects: (i) the response of the PARIS detector to fast neutrons (ii) the study of prompt gamma-ray emission in fast-neutron induced fission [Qi18, Qi20], (iii) the study of the quasi-fission reaction mechanism with the CORSET fission fragment detector [Koz20], (iv) The study of giant resonances in coincidence with low-lying deformed structures, and (v) The study of high-energy gamma ray emission in beta-decay of neutron-rich nuclei.

Hence there has been an excellent synergy between the ALTO facility and the PARIS detector in its development phase. However, it is clear that, as the number of phoswich detectors increases, the demand for use of PARIS in various laboratories will also increase. In this the PARIS Steering Committee has agreed that up to 8 clusters of PARIS will be made available at ALTO to coincide with the  $\nu$ -ball2 campaign.

## Electronics

In 2018, 33 PARIS phoswich detectors were coupled to the  $\nu$ -ball1 spectrometer hosted by ALTO. The fully digital electronics for this high-performance spectrometer are based on the FASTER system developed by LPC Caen (<http://faster.in2p3.fr>), as a generic DAQ capable of digitizing signals from detectors with high energy resolution and excellent (sub-nanosecond) time resolution. The current number of available electronics channels are 184 channels of FASTER electronics, 106 MOSAHR (125 MHz, 14 bit) and 78 CARAS (500 MHz, 12 bit) in 3  $\mu$ TCA crates. The CARAS channels are the most appropriate for use with the PARIS phoswiches.

## Mechanics

Mechanics to couple up to 36 phoswich detectors to the  $\nu$ -ball1 structure already exists and can be used with or without the Ge detectors. The ensemble is on rails to allow access to the target chamber and was designed at IJC lab and constructed at IFJ PAN, Krakow. PARIS clusters can also be mechanically supported for use in the BEDO beta-decay spectrometer in the radioactive beams part of the ALTO facility. PARIS clusters coupled to BEDO have been used successfully in-beam to study the high-energy gamma-ray emission in the beta-decay process, and the possibility of observing low-lying collective resonances. Further developments for integrating more PARIS clusters with BEDO are ongoing with the aim to use PARIS again in future experiments.

## Future use of PARIS at ALTO

Eight clusters from the PARIS project are expected to be available for coupling with  $\nu$ -ball2. The coupling should be straightforward since the development work of the most difficult mechanical support structure (at zero degrees) has already been completed and was used for an experiment in the first  $\nu$ -ball campaign.

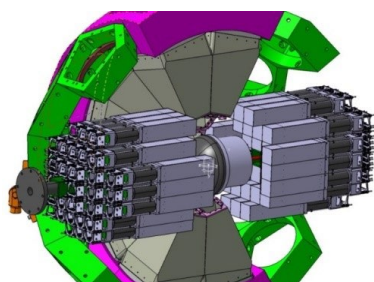

Figure 21 Drawing of the PARIS array coupled to  $\nu$ -ball2.

The mechanical support for the extra four clusters at backward angles will be static, whereas the support at zero degrees moves backwards on rails to allow access to the target chamber. An agreement between IFJ PAN Krakow and the ALTO facility has been established for its design and construction. The total amount of PARIS scintillators (72 phoswiches) will provide a good energy resolution, an excellent time resolution and, most importantly, very high detection efficiency, particularly at high energies (15 MeV). Additionally, it is foreseen to couple this hybrid gamma-detector configuration with the CORSET fission fragment detection

system (shown in the Fig. 22), the Warsaw double sided silicon strip detector (DSSD) and other ancillary devices.

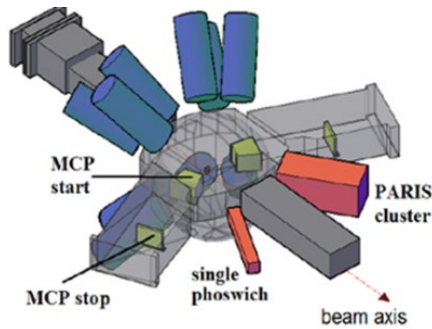

Figure 22: Drawing of PARIS coupled to CORSET [Reprinted by permission from: Springer Nature, The European Physical Journal A - Hadrons and Nuclei, "Features of the Fission Fragments Formed in the Heavy Ion induced  $^{32}\text{S}+^{197}\text{Au}$  reaction near the interaction barrier", E.M. Kozulin et al., Eur. Phys. J. A 56, 6 (2020)].

The ALTO facility and IJC laboratory are able to provide all the necessary infrastructure for the support of the PARIS detectors while hosting these detectors. These include test benches, digitizers, mechanical supports, a range of radioactive sources, diagnostic equipment, etc.

## Physics Cases

The list of physics cases here is no-exhaustive and is just a sample of what could be done with PARIS in the near future at the ALTO facility. The first 5 physics cases are letters of intent for future experiments, while the 6<sup>th</sup> is an experiment already approved by the ALTO PAC.

1. GDR studies with  $\nu$ -ball2/PARIS - *A. Maj, M. Ciemala, M. Kmiecik et al.*
2. Gamma decay from narrow unbound states in n-rich B, C, O and N isotopes: a testing ground for cluster and ab-initio theoretical approaches - *S. Leoni, B. Fornal et al.*
3. Direct measurement of carbon-clustering in  $^{24}\text{Mg}^*$  - *M. Moukaddam, S. Courtin, D. Jenkins et al.*
4. Fusion-fission and quasi-fission studies and ternary fission studies with CORSET, - *I. Matea et al.*
5. Investigating the de-excitation process in nuclear fission - *S. Oberstedt, A. Oberstedt et al.*
6. Coulomb excitation of the super-deformed band in  $^{40}\text{Ca}$  - *P.J. Napiorkowski, K. Hadyńska-Klęk et al.*
7. Pygmy Dipole Resonance population after beta decay around shell closures.

### 1. GDR studies with $\nu$ -ball2/PARIS

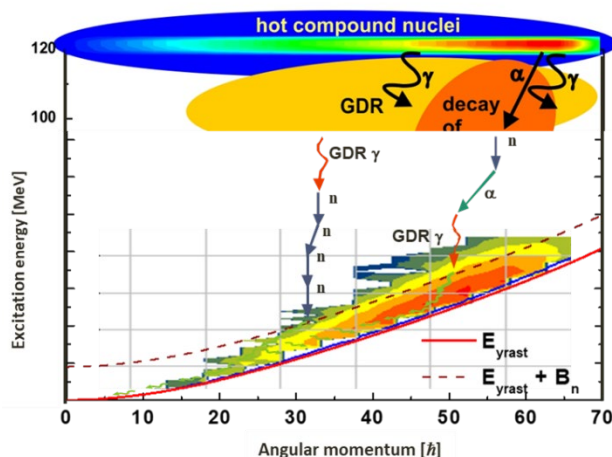

Figure 23: Decay scheme of the hot Compound Nucleus [Kmi20].

Important physics cases which can be addressed with  $\nu$ -ball2/PARIS are the study of giant collective modes as a good probe of the nuclear shape, if the structures of interest can be selected via gating with the Germanium detectors in the array. The study of excited nuclei with such a spectrometer will permit information to be extracted on the link between the deformation of the hot compound nucleus and the deformation of the cold evaporation residues. The low energy transitions detected in the Germanium detectors will allow selection of the deformation of the excited residue and the coincidence



with high-energy Giant Dipole Resonance (GDR) gamma rays detected in PARIS will give information on the form of the GDR and the shape of the hot compound nucleus. The structures of interest to be selected in the cooling residues could for example be used to study the GDR feeding of specific isomeric states (e.g.  $^{188}\text{Pt}$  shape isomer), nuclei exhibiting shape-coexistence of both prolate and oblate states (e.g.  $^{74}\text{K}$ - $^{78}\text{Kr}$ ), superdeformed nuclei (e.g.  $^{42}\text{Ca}$ ,  $^{143}\text{Eu}$ ) and could also be used to search for Jacobi shape transitions.

## **2. Gamma decay from narrow unbound states in n-rich B, C, O and N isotopes: a testing ground for cluster and ab-initio theoretical approaches**

Neutron-rich isotopes of Be, B, C, O, N and Ne offer an extremely fertile ground for nuclear structure studies, besides being of paramount importance for the element nucleosynthesis. These nuclei serve, in fact, as examples of nuclear clustering, although distinct features of shell model are also observed in a number of cases. In recent years, ab-initio type of calculations became capable of computing their excitation energies and decay properties, even above the threshold for particle emission. It is found that electromagnetic decay probabilities, as well as decay branching, show a marked sensitivity to the details of the nuclear force (for example to the inclusion of the 3-body term), especially when moving towards neutron rich systems. A very demanding test of the predictive power of the above-mentioned nuclear models would be the comparison between calculated and measured electromagnetic (EM) properties, in order to pin down the basic features of the wave functions of the excited states (both bound and unbound). In this context, the measurement of electromagnetic decays from unbound states in neutron-rich systems would represent a breakthrough. At present, such information is almost totally missing, as a consequence of  $\gamma$ -decay branching of the order of  $10^{-5}$  -  $10^{-3}$  and even lower, the studies of which call for the use of very selective reaction mechanisms and efficient  $\gamma$  spectrometers, in order to enhance the sensitivity to the population of specific unbound states and to their electromagnetic decays. Measurement of the  $\gamma$ -decay from selected unbound states in neutron-rich isotopes from boron ( $Z=5$ ) to nitrogen ( $Z=7$ ) would be very interesting to study. The focus would be on narrow resonances with a width up to several keV, i.e. corresponding to  $\gamma$ -decay branching of the order of  $10^{-5}$  -  $10^{-3}$ .

## **3. Direct measurement of carbon-clustering in $^{24}\text{Mg}^*$**

A series of reactions with carbon and oxygen were carried out in the 60's depicting a structure of pronounced resonances in the  $^{12}\text{C}+^{12}\text{C}$  system around the energy of the Coulomb barrier. These peculiar resonances suggested that the interacting nuclei still retain their identities within the compound nucleus assimilated to a di-nuclear cluster that can "rotate" or "vibrate" on the resonant states similar to atoms in a molecule, before undergoing a break-up. These resonances have been confirmed, but their structure, inter-band connection and link to cluster states has not been firmly established beyond the case of  $^8\text{Be}$  and their true nature is still a subject of debate. That is mainly due to the missing gamma signature between levels of the same "molecular" resonance. In fact, deciphering the true nature of the di-nuclear  $^{12}\text{C}+^{12}\text{C}$  system could shed more light on the nature of resonances at lower energies playing an important role in the nucleosynthesis of massive stars. The ideal way to investigate these resonances is by measuring the E2 transition between two levels of the corresponding resonance-band. Intense  $^{12}\text{C}$  beams impinging on  $^{12}\text{C}$  carbon targets can be used to populate these short-lived resonances located at relatively high excitation energies, well above the particle decay threshold through fusion reactions. By identifying and measuring the two carbon recoils, emitted at opposite azimuthal angles, one can effectively select the gamma transition of interest. Interestingly enough, resonances in the  $^{12}\text{C} + ^{12}\text{C}$  system, if they would persist at low energies, may have some impact on the carbon burning rates in the late phases of massive stars.

#### 4. Fusion-fission and quasi-fission studies with CORSET

The dynamics of a heavy-ion collision around the Coulomb barrier, viz. the competition between deep-inelastic interactions, fusion and quasi-fission (QF), depends on the complex interplay between various features such as the projectile and target composition and nuclear structure, energy and angular momentum dissipation in the approach phase, etc. Next, the decay of the formed compound remnant(s), by either evaporation or fission, is governed by poorly-known fundamental nuclear properties, including microscopic shell and pairing effects at large deformation, level densities, and nuclear viscosity. The effort invested during the last decades to unambiguously discriminate between the aforementioned channels opened in a heavy-ion collision at energies around the Coulomb barrier, and study the decay of the hot and rotating primary product(s), showed that it is a difficult task. Indeed, several of these processes are similar in many respects, involving (nearly) full momentum transfer. They are nonetheless conceptually distinct in terms of the dynamics driving each outcome. For example, in fusion-fission, the projectile and target fuse into an equilibrated compound that has forgotten the entrance channel, and, depending on fissility, after several  $10^{-20}$  s to  $10^{-16}$  s, fission may occur. In quasi-fission, the system breaks apart before reaching compact equilibrium shapes, often occurring in less than  $10^{-20}$  s. Unfortunately, there exists no direct signature of reaction times, and inconsistent conclusions reported in literature can be attributed to partly unresolved mechanisms. While predominantly devoted to nuclear structure investigations, gamma-ray measurements in coincidence with fission fragment detectors, like CORSET, have shown over the years to be also a valuable probe of reaction dynamics. The multiplicity and energy of the prompt gamma rays are connected to the angular momentum  $L$  and excitation energy  $E^*$ , respectively, while the decay of Giant Dipole Resonances (GDR) critically depends on the deformation of the system. As these three quantities play a key role in determining the dynamics of the collision, and the fate of the potentially-formed compound nucleus, their extraction from experiment constitutes would be highly desirable. The high detection efficiency of the PARIS array for gamma-rays up to 20 MeV makes it an ideal instrument for this type of analysis. Furthermore, the sensitivity of PARIS to neutrons allows for the measurement of neutron multiplicity per fragment as it was demonstrated in a previous experiment performed at ALTO with PARIS [\[Koz20\]](#).

#### 5. Investigating the de-excitation process in nuclear fission

A key ingredient in nuclear fission models is the knowledge about the fission barrier, i.e. the shape of the nuclear landscape around the saddle point. Still intriguing and unresolved is the question, whether the fission barrier is double-humped or even triple-humped and, how deep the 3<sup>rd</sup> minimum is with respect to the 2<sup>nd</sup> one. The today understanding is quite limited as barrier parameters, like height and penetrability, are extracted from calculations describing measured fission cross-sections data. Different models, however, lead to divergent results. Even if there is not a principle doubt about the existence of such a third, hyper-deformed (HD) minimum, a persisting debate deals with the question whether such a minimum is shallow (from the analysis of cross-section data) or as deep as the super-deformed (SD) minimum (investigation of resonance structures below the neutron binding energy). A well-proven tool to precisely map out the fission barrier is to measure the population and decay of the SD states above the shape isomer. As shown for  $^{236}\text{U}$  the investigation of the population and the decay of the shape isomer have provided the most precise value on the ground-state energy of the SD minimum. A systematic measurement of shape isomer half-lives and the branching ratio between shape-isomeric fission and  $\gamma$ -decay back to the normal deformed ground state would provide a consistent and accurate set of fission barrier characteristics helping to benchmark nuclear reaction models.

Starting from a spontaneously fissioning nucleus or from one fissioning after having been excited by e.g. neutron capture or inelastic scattering, the understanding of the share of excitation energy between the fission fragments at scission is mainly based on modelling. Today investigation of



the  $(n, \gamma f)$  process, might shed first light on this. Investigations are presently underway to measure prompt fission neutron and gamma-ray spectral characteristics simultaneously over the relevant neutron energy range. Another interesting process that may contribute to the response, the  $\alpha$ -accompanied (ternary) fission may be employed. Ternary fission occurs in one out of 500 to 600 fissions. Here, the prompt fission gamma-ray spectrum (PFGS) characteristics for ternary fission are expected to show changes compared to that from binary fission, because particle emission reduces the excitation energy of the fission ensemble. Measurements could help revealing the moment of ternary particle emission that is either instantaneously at scission or after binary fission from either of the fragments.

## 6. Coulomb excitation of the super-deformed band in $^{40}\text{Ca}$

The microscopic description of deformation and collective rotation has been a central theme in nuclear structure physics for almost five decades. For nuclei in the lower sd-shell, where the degeneracy of the harmonic oscillator potential remains approximately valid, the connection between deformed oscillator intrinsic states and microscopic wave functions in the laboratory frame was established by Elliot's SU(3) model. For heavier nuclei, however, the spin-orbit interaction breaks the oscillator SU(3) symmetry, and well-developed collective rotation generically involves valence particles/holes in two major shells for both protons and neutrons, making direct shell model diagonalization intractable. Progress in understanding collective rotational motion in these nuclei is thus strongly coupled to the program of identifying approximate symmetries that allow for the inclusion of essential degrees of freedom within an appropriately truncated model space. Such models are ideally tested and refined in cases where the valence space is large enough for collective rotation to develop, yet small enough for full-space shell-model diagonalizations to be performed. Inspection of the single particle energy levels reveals that the  $N \sim Z$  nuclei around  $^{40}_{20}\text{Ca}_{20}$  are excellent candidates for such studies. The large shell gaps at  $\beta_2 \sim 0.4-0.6$  for particle numbers  $N, Z = 16, 18, 20$  lead to the prediction of super-deformed (SD) rotational bands in these nuclei involving valence particles in both the sd and pf shells, yet with valence space dimensions within the reach of modern shell-model calculations. Coulomb excitation is a key experimental method which allows population of important transition strengths for nuclei in this region.

## 7. Pygmy Dipole Resonance population after beta decay around shell closures

An experiment dedicated to the measurement of the high energy gamma spectrum produced in the  $\beta$ -decay of  $^{82,84}\text{Ga}$  by using PARIS array coupled to a beta-detector and high resolution HPGe detectors was performed at the RIB-ALTO facility. Time dependent HFB calculations predict a factor of 2 to 3 enhancement in the PDR strength below 10 MeV when going from  $N=50$  to  $N=52$ , indicated a shell closure effect in low energy dipole distribution in nuclei. The PDR strength is also expected to vary with the isospin and further measurements along the  $N=50$  line will be proposed in the future.

The measurement of the high energy gamma transition after beta decay is also important for the correct determination of the  $B(\text{GT})$  in nuclei. The use of PARIS with high geometrical efficiency allows for a better measurement of the  $B(\text{GT})$  force minimizing the Pandemonium effect often present when high resolution but low efficiency HPGe detectors are used.

# PARIS at the CCB facility of IFJ PAN Kraków

M. Kmiecik, A. Maj, M. Ciemala

Institute of Nuclear Physics Polish Academy of Sciences (IFJ PAN), 31-342 Kraków, ul. Radzikowskiego 152 (Poland)

[www.ifj.edu.pl](http://www.ifj.edu.pl)

## Main collaborating institutions:

Università degli Studi di Milano and INFN, Milano, Italy; KVI-CART, University of Groningen, Netherlands; HIL Warsaw, Poland; University of Warsaw, Poland; FZJ, Inst. Kernphys., Julich, Germany; GANIL Caen, France; RCNP, Osaka, Japan; ATOMKI, Debrecen, Hungary; IPHC Strasbourg, France; JINR Dubna, Russia; IFIN-HH Rumania; IJCLab Orsay, France and the PARIS collaboration

## The CCB facility

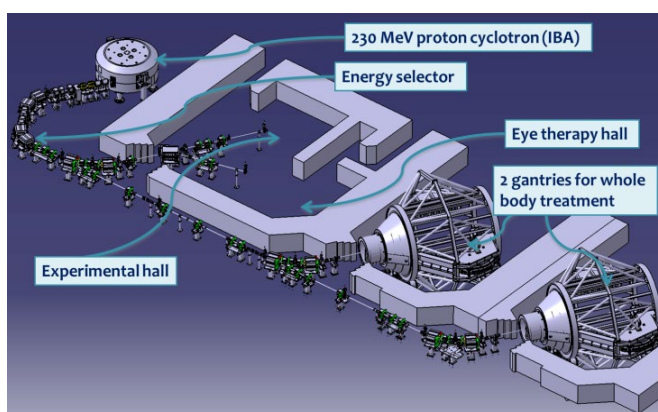

Figure 24: Drawing of the CCB facility at IFJ PAN in Krakow.

The Cyclotron Centre Bronowice (CCB) has been built few years ago as the part of the H. Niewodniczański Institute of Nuclear Physics Polish Academy of Sciences (IFJ PAN) in Kraków. The main task of the CCB is cancer therapy with the use of protons, therefore there are eye therapy room for the proton treatment of eye cancer and two gantries dedicated to whole body irradiation. Other than medical treatment, basic research in the field of: nuclear physics, medical physics, dosimetry and radiobiology, is

conducted in the Centre. There is an experimental hall where nuclear physics experiments are performed. The investigations as well as therapy are carried out based on the proton beam delivered from the cyclotron in a wide range of energy, from 70 to 230 MeV with intensity from 0.1 nA to 500 nA. The energy resolution is defined by the momentum as  $\Delta p/p < 0.7\%$ . The main advantage of the produced beam is the quick alternation between different beam energies and intensities (seconds).

The nuclear physics experiments are carried out mainly during weekends or, alternatively, during afternoons and nights of the weekdays. The beam time is allocated to experiments following the recommendations of the International Advisory Committee.

More information about CCB and how to apply for a beam time can be found at the link: <https://experimentssccb.ifj.edu.pl/?lang=en>

## The use of PARIS at CCB

PARIS detectors have been tested using proton beam at CCB and, afterwards, employed for the measurement of gamma rays in nuclear physics experiments. In 2017 and 2019 up to two PARIS clusters were employed together with the HECTOR BaF<sub>2</sub> array and/or large volume LaBr<sub>3</sub>:Ce detectors and the KRATTA array (triple Si+Csl+Csl telescopes). In 2019 scattered protons were measured simultaneously with the KRATTA array placed in the reaction chamber and operated in vacuum. The gamma rays emitted from <sup>208</sup>Pb in energy regions corresponding to giant dipole

resonances (GDR), giant quadrupole resonances (GQR) and pygmy states (Pygmy Dipole Resonance – PDR) were observed [Was19,Was20].

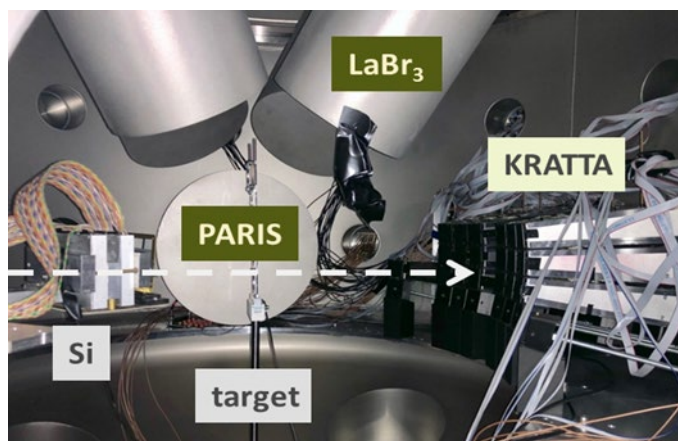

Figure 25. Photo of the inside of the reaction chamber with the mountings of PARIS and LaBr<sub>3</sub>:Ce detectors.

The same setup, but additionally equipped with a thick position-sensitive Si detector mounted inside the chamber for light charged particles detection, was used for the experiment aiming at the investigation of the stretched single-particle M4 state in <sup>13</sup>C, located at 21.47 MeV.

## Electronics

The readout of data from the PARIS + LaBr<sub>3</sub>:Ce + KRATTA detectors used at CCB is based on digital electronics. Eighteen PARIS phoswiches are connected to VME based DAQ system equipped with CAEN V1730 digitizers and driven by the GSI Multi Branch System (MBS). Two 16 channels, 14 bits, 500 MHz/s modules give excellent energy and time resolution, enabling to distinguish between fast and slow signals from PARIS phoswiches. PARIS at CCB works together with 32 KRATTA detectors equipped with VME V1724 100 MHz/s 16 × 8 channels digitizers.

Additionally, every KRATTA module is coupled with 4 plastic scintillators, mounted at the entrance window of the detector, each covering 25 % of its opening angle. The signal from SiPM of plastic scintillator is sent to the CFD and its corresponding time is read by CAEN VME V775 TDC.

To control the experiment the Greware program [Gre07] can be used. It is a very friendly near online analysis software which could be also employed for the data analysis after the measurement.

## Mechanics

In the experimental setup which uses the scattering chamber where KRATTA detectors are placed inside, it is possible to install also two PARIS clusters. They are mounted at 90° with respect to the beam, using holders allowing to place the detectors outside the chamber, at the distance of 25 cm from the target.

## Future use of PARIS at CCB

Presently, with the existing experimental setup, the use of only two PARIS clusters is possible. This setup will be employed for the physics cases listed below. Some ideas of future measurements, proposed in the letters of intent, in which more PARIS clusters are needed, are considered too,

but this will require to build a new scattering chamber. It is also envisaged in the future to employ additional HPGe, LaBr<sub>3</sub>:Ce or other ancillary detectors.

## Physics Cases

The physics cases planned to be studied with the use of PARIS are the following:

1. The gamma decay from high-lying states and giant resonances excited in stable isotopes via (p, p'γ) reaction at 150-200 MeV bombarding energy - *F. Crespi, M. Kmiecik, et al.*
  2. Study of high-lying single-particle states: M4 resonances in <sup>13</sup>C and other light nuclei - *B. Fornal, S. Leoni, et al.*
  3. Investigation of the mechanism of proton-induced reactions from fusion to spallation - *Ch. Schmitt, K. Pysz et al.*
  4. Investigations of (p,2p) reactions in order to identify deep single-particle proton-hole states - *A. Bracco, B. Fornal, et al.*
  5. Gamma decay of GDR in proton induced fusion-evaporation reactions - *F. Camera, M. Kmiecik et al.*
- 1. The gamma decay from high-lying states and giant resonances excited in stable isotopes via (p, p'γ) reaction at 150-200 MeV bombarding energy.**

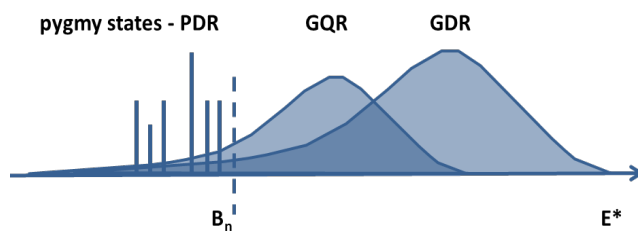

**Figure 26. Schematic picture of Giant Dipole Resonance (GDR), Giant Quadrupole Resonance (GQR) and Pygmy Dipole Resonance (PDR) excitation strengths. The neutron binding energy is indicated by  $B_n$ .**

The study of giant resonances is a research field, which has attracted very much experimental and theoretical attention since the eighties. It is still a very active field because of interesting open problems, among them the gamma decays needed to investigate the microscopic structure of these states. This experiment is part of an extensive study concerning the gamma decay of high-lying states in nuclei, up to

the region of the giant resonances, excited via proton inelastic scattering using the CCB cyclotron of IFJ PAN in Krakow. The main goal is to study the gamma decay from these states, with main focus on the Giant Quadrupole Resonance (GQR) for which very little is known. In particular, the measurements of the gamma branching ratios could test in detail the microscopic structure of the GQR.

Up to now tests and some measurements were carried out for the <sup>208</sup>Pb nucleus and in order to have a better picture on this problem other nuclei in different mass regions should be investigated. For this purpose the nucleus <sup>120</sup>Sn was chosen. In particular the <sup>120</sup>Sn(p,p'γ)<sup>120</sup>Sn reaction is proposed at bombarding energy of 200 MeV.

The differential cross section for the excitation by inelastically scattered protons of the GQR in <sup>120</sup>Sn, at beam energy of 200 MeV was already measured in the past [Ber81]. From these results the maximum of the cross section is expected around 7 – 9°. In particular the cross section for the population of the GQR has been measured to be ~ 10 mb/sr at the maximum located between 5 – 10° c.m. Also in a more recent work [She04] the excitation energy spectrum for <sup>120</sup>Sn measured with the (p, p') reaction at 8 – 10° and beam energy of 200 MeV is clearly showing an enhancement in the region of GQR. However, in these previous works, no measurement of gamma rays was performed. In the planned experiment the PARIS clusters will be used for the detection of gamma rays emitted following the decay from high-lying states and from

the GQR. The good timing of these detectors will be also exploited to well define the coincidence condition and thus to reduce the accidental coincidences and other sources of background. Later other stable nuclei, as another Sn isotopes or Ca, Zn or Ce isotopes, are planned to be investigated.

## 2. Study of high-lying single-particle states: M4 resonances in $^{13}\text{C}$ , $^{14}\text{N}$ and other light nuclei

Stretched states, arising from the promotion of one particle across the shell gap and possessing the highest possible spin which such configuration offers, are the simplest nuclear excitations in the continuum. Their properties are poorly known, even though they are of key importance for

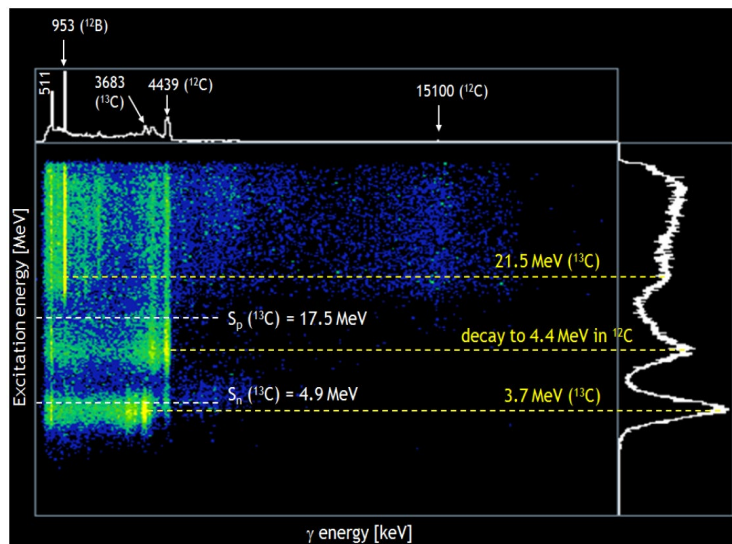

**Figure 27:** Two-dimensional matrix from the  $^{13}\text{C}$  experiment, showing the energy of the gamma rays detected in the  $\text{LaBr}_3:\text{Ce}$  scintillators vs. the energy of the scattered protons in KRATTA. The location of the 21.5 MeV M4 resonance and of excited states in  $^{13}\text{C}$ , which are followed by gamma decays, are indicated (from Ref. [Ciep20]).

inelastically scattered protons (which excite the resonance) in coincidence with charged particles, from the resonance decay, and gamma rays from daughter nuclei. The detection setup consisted of: i) the KRATTA telescope array for detection of scattered protons, ii) two clusters of the PARIS scintillator array and an array of  $\text{LaBr}_3:\text{Ce}$  detectors for gamma-ray measurement, and iii) a thick position-sensitive Si detector for light charged particles detection. As a second physics case, the stretched state at 20.1 MeV in  $^{14}\text{N}$  isotope has been studied employing the same experimental technique.

The experimental results on the decay of the M4 states in  $^{13}\text{C}$  and  $^{14}\text{N}$  will be compared with the theoretical calculations based on the Gamow Shell Model approach, provided by the theory group in Kraków.

The knowledge about the decay of M4 resonances in other p-shell nuclei is also very poor. Therefore, future investigations of the following cases are planned, such as: i) excited states in  $^{12}\text{C}$  above 16 MeV, having strong single-particle-hole components; ii) the M4 resonance previously located at 20.8 MeV in  $^{14}\text{C}$ , with a possible isovector nature, and iii) M4 resonances in  $^{16}\text{O}$ ,  $^{15}\text{N}$ , and  $^{11}\text{B}$  nuclei.

## 3. Investigation of the mechanism of proton-induced reactions from fusion to spallation

Proton-induced reactions are the most abundant nuclear process in nature because the matter of stars in the Main Sequence, the matter in the intergalactic space and the cosmic rays themselves



consist mainly of hydrogen nuclei. Knowledge about the mechanisms and dynamics involved in these reactions is important for astrophysics and astronomy, as well as it can help to understand the interaction between complex heavier ions. Additionally, proton-induced reactions are very important for numerous applications, including nuclear-power production, radioactive waste management, biophysics, etc. We propose to take advantage of the unique specificities of the proton beam and corresponding instrumentation which are being to be available at CCB IFJ PAN, Krakow, in order to study the spallation mechanism in the critical region from 70 to 230 MeV. Experimental information is crucially needed in this regime for the development of predictive state-of-the-art models, as it addresses the transition from a mechanism dominated by nucleon-nucleus (fusion-like) to nucleon-nucleon (intra-nuclear cascade-like) collisions. Aspects such as coalescence, clustering, break-up phenomena, giant resonances, angular momentum and excitation energy generation in the « compound » formed at the early stage of the collision, etc. are intended to be investigated by exclusive measurements of the coincidence between light-charged particles, intermediate-mass fragments and gamma rays over a wide dynamical range. To this end, we propose to use the combination of the elaborate charged particles and fragments detector KRATTA, and the new-generation photon array PARIS. Typical experiments would involve a proton beam at few energies (70, 125 and 200 MeV) impinging on different targets (Al, Fe, Ag, Ta, Pb). Data of this kind are nearly inexistent. They are anticipated to allow a step forward in the field.

#### 4. Investigations of (p,2p) reactions in order to identify deep single-particle proton-hole states

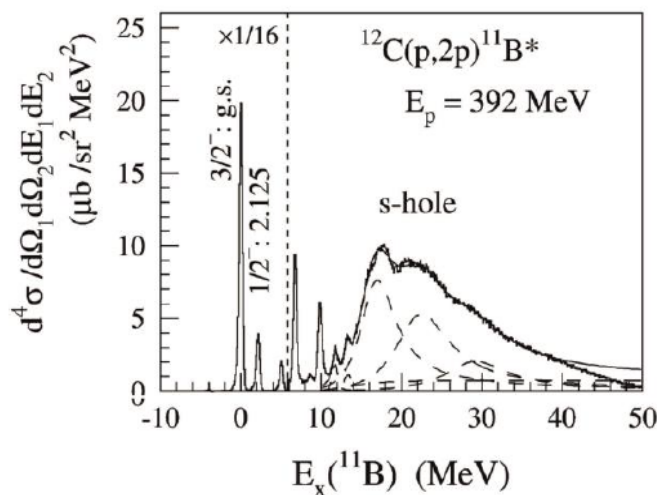

Figure 28. Energy spectrum of  $^{11}\text{B}$  of the  $^{12}\text{C}(p, 2p)^{11}\text{B}^*$  reaction at  $E_p = 392$  MeV (from Ref. [Yos03]).

The 1s-proton-hole state of interest will be observed in the excitation energy spectrum as a broad structure in the region around 20 MeV. Moreover, characteristic gamma rays emitted from the final products of the (p,2p) reaction would be detected in two clusters of the PARIS scintillator array and in an array of  $\text{LaBr}_3:\text{Ce}$  detectors in coincidence with the two outgoing protons. By gating on a specific energy range of that spectrum, coincident gamma-ray spectrum would be used to establish population of excited states in  $^{10}\text{B}$ ,  $^{10}\text{Be}$  and  $^7\text{Li}$  final nuclei which would correspond to evaporation of n, p and alphas from that excitation energy range. In this way, relative branching ratios exclusively for the sequential particle decay of the excited  $^{11}\text{B}$  can be determined. Such data, when compared with results of the work reported in [Yos03] and with the statistical decay model, will provide new information on the character of the 1s-proton-hole state's decay in  $^{11}\text{B}$ .

An experimental program at CCB, aiming at the studies of the direct decay of deeply-bound single-particle states, was proposed. In particular, the 1s-proton-hole state in  $^{11}\text{B}$  populated in proton-knockout reaction  $^{12}\text{C}(p,2p)^{11}\text{B}$  would be investigated. The proton beam from the CCB Cyclotron at its highest energy of 230 MeV would be employed. By summing the energies of both emitted protons, detected in the KRATTA telescope array, the excitation energy spectrum of  $^{11}\text{B}$  (similar to the one shown in Fig. 28) will be reconstructed.

## 5. Gamma-decay of GDR in proton induced fusion-evaporation reactions

The Giant Dipole Resonance (GDR), the collective excitation of nucleus described as the oscillations of neutrons against protons, has been established as a good tool for atomic nuclei studies. From the measurement of high-energy gamma rays emitted in the GDR decay the information on nuclear structure, for example, effective shapes of hot nuclei as a function of temperature/spin, damping mechanism and isospin mixing, can be obtained. In heavy ion fusion reactions, GDR gamma decay is used to probe nuclear shape/deformation and the temperature dependence of GDR damping mechanism. Since the nuclei produced in such processes are characterized by spin and temperature distributions, it is difficult to separate their observed properties into those induced only by spin or temperature.

The use of proton beams can provide an alternative approach for the investigation of nuclear structure using the gamma decay of GDR. In proton induced fusion-evaporation reactions, compound nuclei at low angular momentum values are produced, making possible the study of nuclei at a well-defined temperature without the influence of angular momentum.

With the use of proton beam at CCB of IFJ PAN studies of the temperature evolution of the GDR properties were proposed as a letter of intent. The predicted maximum temperature of investigated nuclei could be of 3-6 MeV, depending on the beam energy and mass of the selected compound nucleus. Two PARIS clusters coupled to four large-volume  $\text{LaBr}_3:\text{Ce}$  will be used for the measurement of high-energy gamma rays from the GDR decay. The fusion-evaporation reaction events could be identified with the use of Si detector placed at backward direction, by the measurement of light charged particles emitted from the compound nucleus decay. Additionally, compound nucleus decay process could be selected using HPGe or  $\text{LaBr}_3:\text{Ce}$  detectors for the measurement of discrete transitions emitted from the excited evaporation residues.

# PARIS at the Laboratori Nazionali di Legnaro

*F. Crespi<sup>1</sup> and M. Cinausero<sup>2</sup>*

<sup>1</sup>*Università degli Studi di Milano and INFN, via Celoria 16, Milano, Italy*

<sup>2</sup>*Laboratori Nazionali di Legnaro, INFN, Viale dell'Università, 2 - 35020 Legnaro (PD), Italy*

## Main Collaborating institutions:

Milano, IFJ PAN Kraków and the PARIS collaboration

## **The LNL facility and available beams**

LNL is one of the four national laboratories of the Italian Institute of Nuclear Physics (INFN). Strength points are the development of particle accelerators, nuclear radiation detectors, and technology transfer. The LNL research activity is mainly based on three different machines: the XTU Tandem electrostatic accelerator used in standalone mode or as injector for the superconducting linear accelerator ALPI and the PIAVE superconducting RFQ ("Radio Frequency Quadrupole"), used as alternative ALPI injector. With the previous configurations (Tandem alone, Tandem + ALPI and PIAVE + ALPI) stable ions from H to Pb can be accelerated with maximum bombarding energies of about 15 – 20 AMeV for the lighter ions ( $A < 32$ ), and about 7 – 10 AMeV for the heavier ones. The list of negative ion beams available to the XTU tandem users can be found at [https://www.lnl.infn.it/~ssi/Ion\\_Beams.htm](https://www.lnl.infn.it/~ssi/Ion_Beams.htm). An average of 3000 hours of beam on target is delivered each year for the Users.

Furthermore, the SPES facility for radioactive beams has entered in the installation phase. SPES is a second generation ISOL type facility based on the fission of a UCx target with a primary proton beam delivered by a high intensity cyclotron. Both, non-reaccelerated and accelerated, unstable beams will be available for experimentalists in the coming years.

## **The use of PARIS at LNL**

In the next years (after 2022) the PARIS array could be used at LNL in combination with:

- A. The AGATA array and additional ancillaries, as for example the PRISMA magnetic spectrometer, the TRACE/GRIT or EUCLIDES arrays and the SPIDER detector for light charged particles detection.
- B. The active target (ATS) to be mainly used for experiments with radioactive beams delivered by SPES.

In the following the two points will be discussed in some details regarding, electronics, mechanics, integration issues and possible physics cases.

### **A. Coupling PARIS with AGATA**

In this Section we will discuss in detail the key points of the use of PARIS in connection with the AGATA campaign at LNL both from the experimental side and from the possible physics case to be investigated.

### **Electronics**

Fully digital electronics for PARIS will be used. It will exploit the electronics used for the LaBr<sub>3</sub>:Ce detectors that is presently employed together with the GALILEO array. This electronics is capable



of digitizing signals from detectors with high energy resolution and excellent (sub-nanosecond) time resolution. The current number of available electronics channels is 96.

## Mechanics

Mechanics to couple up to 36 phoswich detectors to the AGATA structure partly exists since this mechanics is the same which is being constructed for the NEDA neutron array and has the flexibility to be used also for PARIS. Specific holders and flanges to hold the PARIS detectors should be built.

### Future use of PARIS at LNL with AGATA

Eight clusters from the PARIS project will be available for coupling with AGATA. Both configurations foreseen for AGATA at LNL, i.e., with the PRISMA magnetic spectrometer and at zero degree, will be considered. In one configuration the mechanical support structure is already under study, as it is designed for installation of different type of modular ancillaries (see Fig. 29). In the second, which is a more complicated configuration, the mechanical coupling of PARIS with AGATA at PRISMA will be studied by Legnaro and by the PARIS collaboration.

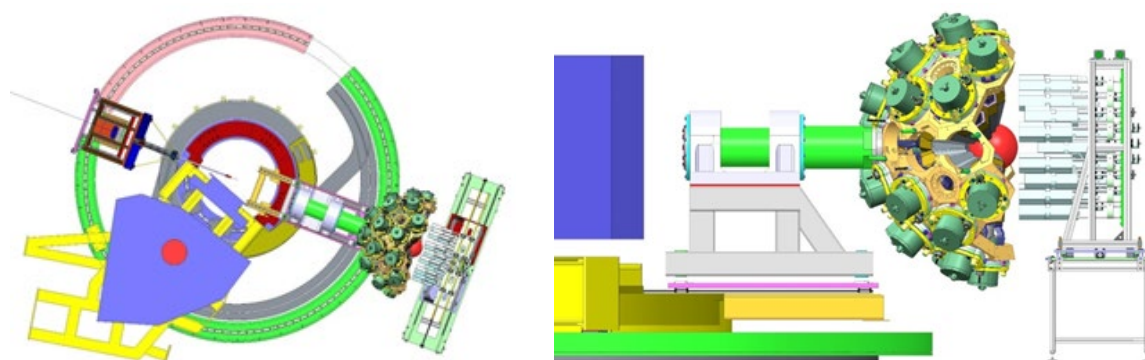

Figure 29. Configuration of AGATA at LNL coupled at 0 degree with an array of modular detectors in wall configuration (such as NEDA or PARIS). Left panel: view from the top. Right panel: view from the side.

### Physics Cases for PARIS+AGATA at LNL

The present list of physics cases is not exhaustive and it is based on Letters of Intent discussed in March 2019 in a workshop at LNL. Using the ATS, it will be possible to investigate the Pygmy Dipole Resonance (PDR) by measuring the inelastic scattering in inverse kinematics using radioactive beams from SPES. Using He and H gases we have the opportunity to study both the Isoscalar and Isovector component.

1. Gamma strength functions and decay pattern of dipole excitations - *J. Isaak et al.*
2. Study on single-particle structure of pygmy dipole resonance - *M. Krzysiek, F.C.L. Crespi et al.*
3. Gamma and particle decay of Giant Resonances excited by inelastic scattering of  $^{17}\text{O}$  ions at 20 MeV/A - *F.C.L. Crespi, A. Bracco et al.*
4. The search for Jacobi shape transitions in the Mo-Ba region - *M. Kmiecik, A. Maj, A. Bracco et al.*
5. The feeding of superdeformed bands - *G. Benzoni, M. Kmiecik et al.*
6. Measurement of Isospin Mixing in hot nuclei - *G. Gosta, F. Camera et al.*
7. Approach to the superdeformation in the mass A=40 region at low and high spins - *K. Hadyńska-Klęk, P. Bednarczyk et al.*
8. High spin structure in the vicinity of  $^{44}\text{Ti}$  - *P. Bednarczyk et al.*

9. Onset of collectivization/clusterization in Oxygen neutron-nuclei - *S. Ziliani, S. Leoni, B. Fornal et al.*
10. Lifetime measurements of excited states in neutron-rich C isotopes: a test of three-body forces - *M. Ciemala, B. Fornal, S. Leoni et al.*
11. The GDR in hot superheavy nuclei - *M. Vandebrouck, A. Maj et al.*

### 1. Gamma strength functions and decay pattern of dipole excitations

The electromagnetic absorption and decay processes are important reactions for the modeling of the nucleosynthesis of most of the elements heavier than iron. One of the main input quantities is the Strength Function which describes the average probability to emit or absorb radiation with a given gamma-ray energy. Very recently, the SF was studied in  $^{128}\text{Te}$  using a model-independent approach via coincidence measurements exploiting quasi-monochromatic photon beams. The data obtained for the energy region below the neutron threshold indicate that the SF extracted from the absorption channel is different from the one determined from the decay and that the latter one depends on the excitation energy. Both results are in contradiction to the Brink-Axel hypothesis and, thus, the assumption within the statistical model. However, SFs extracted from particle-induced reactions, show a certain degree of agreement in other nuclei. Therefore, it is proposed to extend this type of investigations at LNL with PARIS and AGATA using inelastic proton scattering, with proton to be detected with the TRACE array.

### 2. Study on single-particle structure of pygmy dipole resonance

In order to study the collectivity of the Pygmy Dipole Resonance (PDR), it is proposed to utilize neutron-transfer reactions which would be sensitive to single-particle excitations. One such study has been done using the  $^{119}\text{Sn}(d,p)^{120}\text{Sn}$  reaction. Another good candidate would be the ( $^{13}\text{C},^{12}\text{C}$ ) reaction on stable Ca isotopes which are very-well studied theoretically and, for most of them, Nuclear Resonance Fluorescence (NRF) data for comparison exist. For example: the  $^{43}\text{Ca}(^{13}\text{C},^{12}\text{C})^{44}\text{Ca}$  reaction has a high positive Q value, i.e.,  $Q = 6.18$  MeV. To reach the excitation energy  $E_x = 15$  MeV, the energy threshold is 11.48 MeV. Beam energy should be kept low ( $< 25$  MeV) to reduce contribution from fusion-evaporation.

The NRF data for  $^{44}\text{Ca}$  show high density of E1 states below the neutron threshold Sn, which is typical for open-shell nuclei. This makes it a good candidate to study the structure of these states.

### 3. Gamma and particle decay of Giant Resonances excited by inelastic scattering of $^{17}\text{O}$ ions at 20 MeV/A

The study of Giant Resonances, a clear manifestation of the nuclear collective motion, is very interesting both for its excitation features and the decay properties. The decay from these states reflects the two main components of the GRs width. One is  $\Gamma^\downarrow$ , the compound damping width coming from the coupling of GRs to progressively more complicated states. The escape width  $\Gamma^\uparrow$  is associated to the direct emission of particles to the continuum. In addition, the gamma decay width  $\Gamma_\gamma$ , which is a small fraction of the total, is also a powerful probe for model predictions. The decay quantities, altogether, allow to enter into the microscopic structure of the GRs states. Recently a completely microscopic model based on Skyrme functionals has been developed, showing the sensitivity to the chosen interactions which need to be tested with measurements.

Concerning the gamma decay, up to now only few measurements were done, the latest one being the decay of the IVGDR in  $^{90}\text{Zr}$  (at RCNP, Osaka) and the decay of the ISGQR in  $^{208}\text{Pb}$  (at CCB, Kraków), both using inelastic scattering of protons. Given the present situation on the measurement of the gamma and particle decay from GRs, it is clear that there is a need for further investigations. Experiments are proposed at LNL to study the gamma and particle decay from giant resonances in different nuclei using AGATA coupled to HECTOR+, the PARIS phoswich

array, and the TRACE silicon particle detectors. The GRs modes will be excited by inelastic scattering of  $^{17}\text{O}$  at 20 MeV/A.

#### 4. The search for Jacobi shape transitions in the Mo-Ba region

The Jacobi shape transition, predicted to occur for many nuclei at high angular momenta, is a phenomenon consisting in an abrupt change of the nucleus shape from oblate, through tri-axial, to more and more elongated shapes. So far, it was observed only in the  $A \sim 40$  mass region [Maj04]. Another region, where very extreme spins can be reached, corresponds to  $90 < A < 140$ , as here the limiting angular momentum for the fission process is very high. The shape evolution of hot nuclei in the  $A \sim 100$  and  $A \sim 130$  mass regions, at extreme angular momenta, will be investigated by the measurement of high-energy gamma rays from the Giant Dipole Resonance (GDR) decay in coincidence with light charged particles and discrete transitions in evaporation residues, using AGATA coupled to PARIS, and EUCLIDES detectors. As the GDR is known to be a very good tool for studies of nuclei under extreme conditions, at high temperature or angular momentum, it will serve as a probe for testing the shape of the investigated nuclei.

The Jacobi transition is intended to be studied for  $^{96}\text{Mo}$  and  $^{130}\text{Ba}$  compound nuclei created at high excitation energy and high angular momentum, close to the fission barrier. For both compound nuclei, the Jacobi shapes are predicted to occur in the high spin region encompassing the highest possible deformations of the nucleus before it fissions.

The experimental selection of events corresponding to high angular momenta will be possible by choosing particular decay channels, especially those with one alpha-particle emission. The Jacobi shape transition will be studied by the measurement of high-energy gamma rays from the GDR decay in coincidence with alpha particles. The low spin gamma transitions in the final reaction products, registered at the same time, will help to determine the required decay channel.

#### 5. The feeding of superdeformed bands

The feeding of superdeformed bands via the GDR gamma decay is a problem that still needs to be investigated, owing to the extremely limited experimental information currently available [Bra01]. The GDR in superdeformed nuclei is expected to be very splitted with a low energy component at around the neutron binding energy which is expected to enhance the population of superdeformed nuclear states. The high efficiencies today available are expected to provide sufficient statistics to address this interesting aspect of nuclear structure.

#### 6. Measurement of Isospin Mixing in hot nuclei

It is proposed to measure the Isospin mixing coefficient " $\alpha^2$ " in the  $N=Z$  nucleus  $^{52}\text{Fe}$  (or in lighter  $N=Z$  nuclei). For these measurements the plan is to use AGATA coupled to i) large volume  $\text{LaBr}_3:\text{Ce}$  detectors, ii) the clusters of the PARIS array (eight clusters, namely 72 phoswiches, are expected to be present in 2022) and, if available, iii) a small array of large volume ( $3'' \times 3''$ ) CLYC detectors.

It is well known that the isospin symmetry is largely preserved by the nuclear interaction. In fact, the isospin symmetry is based on the experimental evidence of charge independence symmetry of the nuclear interaction. This symmetry is however broken by the Coulomb interaction. The Coulomb force induces Isospin impurities in the nuclear wave function. This effect has an impact on some nuclear properties, as for example the beta decay and E1 decay yields. At high excitation energy, the isospin symmetry is partially restored because of the interplay between the time required to mix and the time required to emit a particle (changing isospin).

In general, there are three techniques which can be used to estimate the isospin mixing. All of them are based on the measurement of a nuclear decay (beta or gamma) which is expected to be

forbidden. The consequent comparison with a scenario where the Isospin is fully conserved provides an estimate of the  $\alpha_2$  coefficient. For the E1 transitions, the giant dipole resonance (GDR), where the maximum E1 strength is concentrated, is ideal for searching for small effects in the breaking of the associated selection rule [Cer15]. In the proposed experiment, AGATA will be used to measure low energy gamma rays for a quantitative identification of the populated residues. The large volume LaBr<sub>3</sub>:Ce plus the PARIS clusters will be used to measure the high-energy gamma rays emitted in the decay of the GDR built on the <sup>52</sup>Fe Compound Nucleus (CN). In addition, the 72 small (2"×2") frontal LaBr<sub>3</sub>:Ce of the PARIS phoswiches will act as a multiplicity filter which can measure the fold spectra, in order to extract the angular momentum distribution of the populated residues and of the CN.

## 7. Coulomb excitation of the super-deformed structures in A ~ 40 mass region

Around 300 super-deformed (SD) structures were observed to date, in various regions of the nuclear chart. In particular, SD bands were discovered in light nuclei (e.g., A ~ 40). The value of the quadrupole deformation parameter,  $\beta$ , in the side bands of <sup>40,42</sup>Ca, <sup>36,38,40</sup>Ar and <sup>44</sup>Ti nuclei was measured between 0.4 - 0.6. A dedicated safe energy Coulomb excitation campaign is planned at INFN LNL to study the SD structures in the stable nuclei from the region between <sup>28</sup>Si to <sup>56</sup>Ni where the shell structure with the available excitation to pf shell allow to form the collective rotational and deformed bands of similar properties, decaying to the ground state bands with discrete gamma transitions. This project is intended to determine the low-spin electromagnetic structure of the isotopes of interest, in particular in <sup>36,38,40</sup>Ar, <sup>40,42,44,46,48</sup>Ca and <sup>46,48,50</sup>Ti. The gamma rays in the energy range between 0.3 MeV up to 6 MeV will be measured in coincidence with the SPIDER array covering the backward laboratory angles. The expected level of statistics will allow to precisely determine the deformation of the yrast and SD bands, for the first time, in a model independent way. It will be possible to study also secondary order effects, such as the nuclear reorientation, which will allow the extraction of spectroscopic quadrupole moments in the ground state and SD bands.

## 8. High spin structure in the vicinity of <sup>44</sup>Ti

In the  $f_{7/2}$  shell nuclei close to the N=Z, rotational bands in the <sup>44</sup>Ti nucleus are a signature of significant collectivity, developing in these relatively light systems. Of special interest are many particle-hole excitations that give rise to superdeformed bands reported in <sup>44</sup>Ti and in some lighter isotopes of Argon and Calcium: <sup>36,38,40</sup>Ar and <sup>40,42</sup>Ca. Such very elongated prolate shapes have been also identified via GDR and charged particle studies in the neighboring <sup>46</sup>Ti and <sup>47</sup>V nuclei at high temperature, what was related to the Jacobi shape transition. Also, recent Coulex experiments revealed that in <sup>42</sup>Ca the low-lying SD bandhead is associated with highly deformed triaxial shape [Had16]. There exist various theoretical interpretations of the superdeformation in the N ~ Z, A ~ 40 nuclei. In the framework of the Large-Scale Shell Model (LSSM), SD states result from multiple particle-hole excitations across the magic N=Z=20 and the calculations in the full fp configuration space are in general in very good agreement with experimental data. However, the LSSM approach predicts a termination of the SD bands at relatively low angular momentum corresponding to the full spin alignment. On the other hand, Energy Density Functional (EDF) calculations based on the Cranked Relativistic Mean-field point out that the extremely deformed shapes of these nuclei are due to clusterization of nucleons, that can form molecular-like structures. Such exotic configurations should be favored at high spins and they are expected to constitute the yrast line.

High spin states in the <sup>40</sup>Ca - <sup>56</sup>Ni region can be excited in fusion-evaporation reactions with intense stable beams, as for example Mg or Si. The AGATA and PARIS gamma-ray spectrometers will be combined with particle and recoil detectors, such as EUCLIDES and the Recoil Filter Detector (RFD) in order to increase the resolving power. Such a detector combination will enable

the identification of the SD structures decaying via fast, discrete E2 transitions. Expected feeding of these SD bands by high energy E1  $\gamma$ -transitions can be proven. In addition, correlated emission of  $\alpha$ -particles can be also investigated. The experiments may shed new light on the expected link between molecular resonances or collective modes, expected in a hot compound nucleus, and a very elongated shape of the evaporation residuum.

### 9. Onset of collectivization/clusterization in oxygen neutron-nuclei

Near-threshold states in nuclei, i.e., states lying in close proximity of the particle-emission threshold, are at the basis of our understanding of the creation of elements in nucleosynthesis reactions – the most famous example is the Hoyle state in  $^{12}\text{C}$ , lying only 287 keV above the alpha-decay threshold. The importance of these states for nucleosynthesis relies on the existence of gamma-decay branches, toward the ground state, which dictate the production rate of the nucleus of interest, following capture into the near-threshold state.

From the theory point of view, a comprehensive description of the structure of near threshold states goes beyond standard shell-model and cluster-model frameworks, and requires the open quantum system framework provided by the Continuum Shell Model [Ok03]. In neutron-rich systems, this approach predicts an enhanced collectivization in the near-threshold state, which carries many features of the nearby decay channel. It is also expected a gamma-decay emission enhanced by large factors, from 10 to 100, as compared with standard shell-model calculations.

The gamma decay from unbound near-threshold states, in light neutron-rich nuclei, should therefore provide information on the collectivization effect, which is considered to be a very general property of near-threshold states in nuclear systems, and the key microscopic mechanism leading to the onset of nuclear clustering. This is an almost unexplored territory and AGATA coupled to PARIS could allow to access electromagnetic decays from near-threshold states in a number of neutron-rich B, C, O and N nuclei, with decay branches of the order of  $10^{-6}$ - $10^{-5}$ . Fusion reactions induced by intense Li beams on Be, C, Li and B targets, followed by the evaporation of a single charged particle, detected in a highly segmented detection system (e.g., TRACE or GRIT) could be exploited to populate the near-threshold states of interest, with cross sections of few mb.

### 10. Lifetime measurements of excited states in neutron-rich C isotopes: a test of the three-body forces

There is large interest to investigate excited states in n-rich B, C, N, O and F nuclei, which can be populated by multi-nucleon transfer reactions induced by an  $^{18}\text{O}$  beam on a  $^{188}\text{Pt}$  target. For these nuclei, limited spectroscopic information is available, especially in terms of the lifetimes of the excited states.

The main focus of the experiment proposed at LNL will be on C isotopes, in particular  $^{16-18}\text{C}$ . In these nuclei, *ab initio* calculations provide, in fact, a detailed description of the excited states and predict a strong sensitivity of the electromagnetic transition probabilities to the details of the nucleon-nucleon interactions, especially in connection with the role played by the three-body (NNN) forces. No-core shell model calculations (NCSM) without and with inclusion of the NNN term, predict B(E2) and B(M1) of the second  $2^+$  states to vary by a factor of 3 to 5. For example, for  $^{16}\text{C}$ , the calculated lifetime of the second  $2^+$  with two-body (NN) forces, only, is equal to 350 fs, versus 80 fs with NN+NNN forces included. Test of the importance of three-body forces in describing electromagnetic properties of selected states requires a precise measurement of i) lifetimes of the second  $2^+$  states, ii) decay branches from the second  $2^+$  state to the ground state and to the first  $2^+$  state, and iii) the E2/M1 mixing ratio of  $\gamma$  transitions of interest, which will be accurately determined by the AGATA array.

A recent experiment performed at GANIL, employing the AGATA+VAMOS+PARIS setup and focusing on the determination of the  $^{20}\text{O}$  second  $2^+$  state lifetime [Cie20], showed that this type of setup is well suited for such measurements. The AGATA, PARIS and PRISMA configurations at LNL will significantly improve the result accuracy and will allow to test theory predictions on very exotic systems where the impact of three-body forces is expected to be the largest.

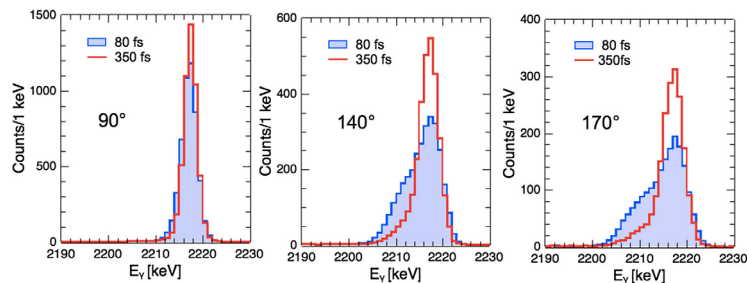

Figure 30. Simulated lineshapes measured by AGATA, in the AGATA+PARIS+PRISMA setup, for the 2217 keV transition deexciting the second  $2^+$  state of the hard-to-reach nucleus  $^{16}\text{C}$ , produced in the deep-inelastic reaction  $^{18}\text{O}+^{181}\text{Ta}$  at  $v/c \sim 10\%$ . Lifetime values of 350 fs and 80 fs are considered, as predicted by ab initio theories, including NN or NN+NNN forces, respectively [Kor20].

## 11. The GDR in hot superheavy nuclei

The isovector giant dipole resonance (IVGDR) is a collective excitation mode of the nucleus in which protons and neutrons are moving out of phase. According to the Brink-Axel hypothesis, the properties of the IVGDR are the same, whether the IVGDR is built on the ground state or on an excited state. Applying this hypothesis to highly excited compound nuclei formed in fusion reactions, allows to probe this collective excitation mode in superheavy nuclei (SHN). In addition to provide information on the collective behavior in SHN, the study of IVGDR in SHN could help answering questions related to the deformation and to the fission dynamics in this region of the nuclear chart. This approach is particularly interesting since, due to the involved low production cross-sections in this mass region, it is difficult to have access to nuclear structure information.

At LNL, it is proposed the study of the IVGDR in hot superheavy nuclei produced by fusion reactions at high excitation energy. To characterize the IVGDR in SHN, we plan to extract the pre-fission gamma-ray energy spectra as well as the  $\gamma$  angular correlations in respect to the fission axis. It is proposed the use of the PARIS for high-energy gamma detection in coincidence with the PRISMA spectrometer used to detect fission fragments velocities and kinetic energies. In addition, the low energy component of the GDR tail will be studied with AGATA.

## B. Coupling PARIS with ATS

### The ATS active target for SPES: concept, electronics and mechanical solutions

The Active Target for SPES (ATS) is presently based on the ACTAR Demonstrator developed by the ACTAR collaboration. It will be optimized for re-accelerated exotic beams from SPES. Active targets are, in fact, promising devices to be used at Radioactive Ion Beam facilities, allowing to exploit low intensity beams with good efficiency. Indeed, the use of a gas volume as a target for Nuclear Reactions and as a detector for the emitted particles offers substantial advantages in terms of luminosity and detection thresholds. Moreover, the tracking capabilities allow measuring the exact interaction energy, strongly reducing the uncertainty due to solid target thickness. At the same time, measuring intervals of excitation functions without changing the settings of the setup becomes possible. Currently, ATS uses the ACTAR Demonstrator as detector and custom silicon detector arrays as ancillaries for  $\Delta E$ -E particle detection and identification. The ACTAR



Demonstrator detector consists of a gas chamber where the gas is used, at the same time, as a target for nuclear reactions and as a detector for ionizing radiation. An electric field projects the electrons freed by ionization on a two-dimensional ( $128 \times 64 \text{ mm}^2$ ) pixelated pad plane (each pixel is  $2 \times 2 \text{ mm}^2$ ). Before collection, the electrons are amplified by a micromegas layer. There are 2048 independently-read pixels in total on the horizontal plane. Since the collection time can also be measured, the detector can be operated as a time projection chamber and a 3D image of the tracks can be obtained.

GET electronics is used for readout and allows pad by pad gain and trigger setting. For the coupling of the GET Electronics with the PARIS digital electronics dedicated work is needed.

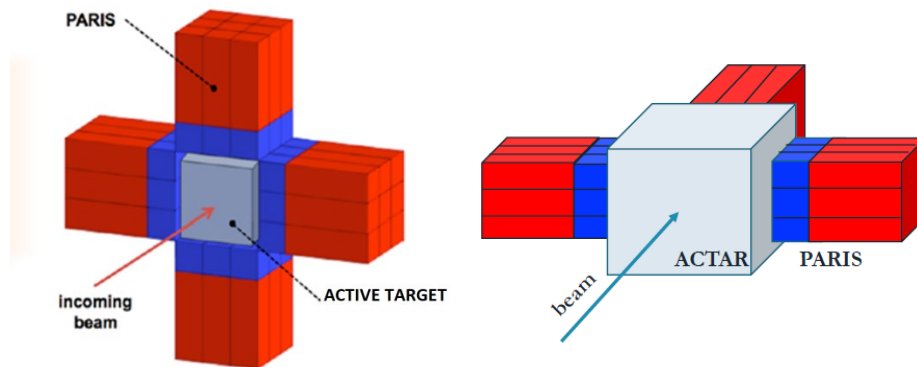

Figure 31. Two possible conceptual drawings for the coupling of PARIS modules with an Active Target.

Figure 31 sketches the coupling of PARIS detectors with the ATS. The illustrated concept has to be developed on the basis of the final ATS set-up configuration and of the wanted detection efficiency. Possibly, thinner ATS side walls have to be considered for optimal coupling of the gamma detector modules.

## Physics cases PARIS + ATS at LNL

Coupling the ATS with PARIS will allow to exploit the sensitivity of a gaseous target with tracking capabilities coupled to the selectivity of a gamma-ray detection array like PARIS. For low beam intensities applications, high efficiency ancillaries are needed, therefore HPGe detectors are not an option. High-resolution scintillation crystals like the  $\text{CeBr}_3$  and  $\text{LaBr}_3:\text{Ce}$  of PARIS, offer the proper trade-off.

There are two main categories of experiments to be carried out at SPES using an ACTIVE Target coupled to gamma-ray detectors: transfer reactions to study the structure of exotic nuclei, and inelastic scattering for collective nuclear excitation mode studies. One example for each subject is here reported.

### 1. Transfer reactions with neutron-rich Sn nuclei.

The doubly-magic nucleus  $^{132}\text{Sn}$  represents a milestone in the intermediate-mass neutron-rich region. Its properties have been studied through a variety of experimental techniques including: beta decay from  $^{132}\text{In}$  [Ker73]; beta delayed neutron emission from  $^{133}\text{In}$  [Hof96]; Coulomb excitation [Rad04] and most recently via the  $^{132}\text{Sn}(d,p)^{133}\text{Sn}$  reaction [Jon10]. Proton angular distributions were used to determine the spin and parity of excited states in  $^{133}\text{Sn}$ , while the derived spectroscopic factors revealed that the ground and excited states in  $^{133}\text{Sn}$  can be described by a single neutron beyond a doubly-magic  $^{132}\text{Sn}$  core and occupying the  $f_{7/2}$ ,  $p_{3/2}$ ,  $p_{1/2}$ , and  $f_{5/2}$  orbitals.



Beyond  $^{132}\text{Sn}$  few experimental data are available. Ground state masses and some excited states are known up to  $^{135}\text{Sn}$  [Sch13], while for  $^{136-137}\text{Sn}$  only the half-life [She02] and the first  $2^+$  state in  $^{136}\text{Sn}$  [Wan14] have been measured. When adding neutrons to the doubly-magic  $^{132}\text{Sn}$ , one might expect the  $f_{7/2}$  orbital migration in relation to the  $p_{3/2}$ . These phenomena could give rise to a new magic number at  $N=90$ , in direct analogy with respect to  $^{42}\text{Ca}$ , that is comprised of two  $f_{7/2}$  neutrons beyond a doubly magic  $^{40}\text{Ca}$  core. One can speculate that the migration of  $f_{7/2}$  relative to  $p_{3/2}$  observed across the Ca isotopic chain and producing a second doubly magic nucleus at  $^{48}\text{Ca}$  is also plausible for the neutron-rich Sn isotopes giving rise to the  $N=90$  neutron magic number.

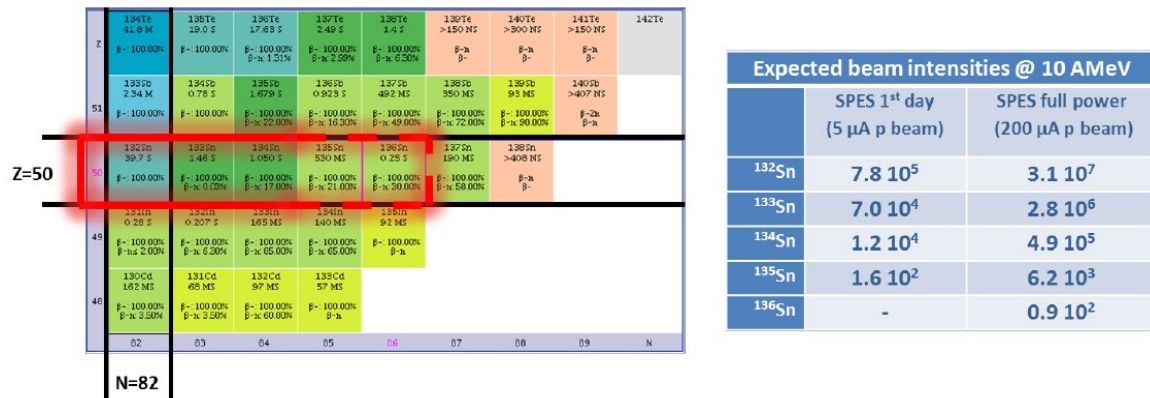

Figure 32. Expected beam intensities at SPES for the Sn isotopic chain.

Given the estimated intensities for the day 1 SPES facility beams (see Fig. 32), the study of the  $^{134}\text{Sn}(d,p)^{135}\text{Sn}$  transfer reaction is feasible, and coupling the device with a gamma-ray array could provide the selectivity needed for a proper tagging of the observed transitions.

## 2. Collective excitation modes.

The study of Giant Resonances by means of inelastic scattering has been already illustrated for the PARIS+AGATA configuration. In that case the main focus is on the gamma rays emitted by the resonance de-excitation. Both isovector and isoscalar modes can be studied.

The same cases can be addressed by the PARIS+ATS setup using a complementary approach where particles can be tracked down to the interaction vertex. In this case, the angular distributions of low-energy light-particles emitted in inelastic collisions could be measured and tracked (ATS). Moreover, the event could be tagged by the coincidence with (high-energy) gamma-rays (PARIS). Collective modes are often populated in inelastic scattering reactions using gaseous targets like hydrogen and helium. The use of a tracking gaseous target helps in overcoming many of the limitations of conventional gas targets. Oxygen isotopes induced reactions at 20 AMeV have already been mentioned for the PARIS+AGATA configuration. In the ATS case, pure H and quasi-pure He gas targets could be employed with the addition of the vertex reconstruction capability that allows to directly measure the effective reaction energy, together with low thresholds and good angular resolutions for light charged particles detection.

## PARIS at the Pelletron Linac facility, Mumbai

*V. Nanal and R. Palit*

*DNAP, TIFR – Mumbai  
for the PARIS collaboration*

### Main Collaborating institutions:

TIFR, BARC, VECC

The Pelletron Linac facility (PLF), set up as a collaborative project between the Bhabha Atomic Research Centre (BARC) and the Tata Institute of Fundamental Research (TIFR), has been a major Centre for the heavy ion accelerator-based research in India [Nan18]. The Pelletron accelerator (procured from NEC, USA) was formally inaugurated on 30<sup>th</sup> December 1988 and marked an important milestone in nuclear physics research in India. The facility was augmented with the indigenously developed superconducting LINAC booster to enhance the energy of the accelerated beams [Gos16]. The phase I of LINAC booster was commissioned on 22<sup>nd</sup> September 2002 and the facility was dedicated to users on 28<sup>th</sup> November 2007 after the completion of the phase II. A variety of state-of-the-art experimental facilities have been developed at this Centre to pursue frontier research in nuclear, atomic, condensed matter and bio-environmental physics.

Over the last three decades, the Pelletron accelerator has been working very well with an efficiency of ~ 80%, delivering a wide variety of beams ranging from proton to Iodine. Major experimental facilities/instruments include:

- Clover Detector Array for discrete gamma-ray spectroscopy with auxiliary detectors (INGA).
- 150 cm diameter Scattering Chamber, with two independently rotatable arms permitting detector rotation and target ladder adjustment from remote, without beam interruption using Programmable Logic Controller, for charged particle spectroscopy and fission studies.
- BaF<sub>2</sub>/LaBr<sub>3</sub> array for high energy gamma ray studies with BGO/NaI(Tl) multiplicity filter.
- Charged Particle Array based on Si pad ( $\Delta E$ ) and CsI(E) detectors.
- Neutron Detectors Array of 18 Liquid Scintillation detectors and Annular parallel plate avalanche counter having 12 segmented signals read out with angular coverage from 5° to 11°, for Time of Flight Technique based compound nucleus residue tagging.
- MWPC and Si-strip detectors for angular distribution measurements of particles.
- 7.0 tesla superconducting magnet for hyperfine interaction studies.
- Irradiation setup and Low background offline counting facility.
- Electron spectrometer, X-ray detector setups, recoil-ion spectrometer, a surfatron-based-atomic-hydrogen source and a multiple target holder assembly for atomic physics studies with gas and foil targets.

More details about facility, programs and publications can be found at the PLF webpage <http://www.tifr.res.in/~pell/pelletron/index.php> and in [Nan18]. The PLF typically operates 8 – 9 months per year to perform a wide variety of experiments with experimental community comprising scientists and students from BARC, TIFR, other research centers and universities within India and abroad, proposed by local, national and international users.

## The use of PARIS at PLF

The collaborators from PARIS-INDIA group have been actively involved in PARIS detector R&D, right from the beginning. Detailed characterization and energy adback studies over a wide energy range (up to 22 MeV) were carried out during 2012-14, using proton induced reactions with ECRIS facility and PLF, Mumbai [[Gos16](#)]. In-beam test with 4 detector clusters was also carried out during 2017.

PARIS Detectors will be used in two different configurations – in conjunction with INGA and with other detectors specific to experiments. For experiments with INGA a few clovers will be replaced with a 4-detector PARIS mini-cluster. Simulations have been carried out for the proposed configurations. The coupling of PARIS detectors with other detectors like INGA, multiplicity filter, DSSD arrays will open up new physics opportunities and hence it is proposed to perform experiments with PARIS with at least 2 clusters (18 detectors), at PLF during 2021-22<sup>1</sup>.

## Electronics

The PARIS phoswich detectors have been used and tested with CAEN V1721 500 MHz digitizer. The DDAQ of INGA at TIFR is based on 100 MHz digitizers from XIA, LLC [[Pal12](#)]. Recently, the DDAQ of CS-Clovers of INGA based on 100 MHz digitizers has been coupled with the DDAQ of the LaBr<sub>3</sub>:Ce array with 250 MHz digitizers using two-crate synchronization technique with a trigger module [[Las21](#)]. For coupling the INGA with the PARIS array and the CsI(Tl) array, a similar multi-crate digital DAQ with XIA digitizers will be possible.

## Physics Cases

A representative list of physics cases is given here:

1. High spin structure of nuclei near <sup>90</sup>Zr (*R. Palit, et al.*).
2. Study of the population of coexisting shapes in A ~ 130 region through high-energy gamma ray measurements (*F.S. Babra, R. Palit, et al.*).
3. Jacobi shape transition (*V. Nanal, et al.*).

### 1. High spin structure of nuclei near <sup>90</sup>Zr

A number of heavy ion induced fusion reactions are used to study nuclei near <sup>90</sup>Zr. Most of the cases, the nucleus does not develop a well-deformed band structure even at high excitation energy. It is also rather surprising that, although the expected angular momentum imparted classically in the heavy-ion fusion evaporation reactions (<sup>13</sup>C + <sup>80</sup>Se @ 60 MeV, <sup>28</sup>Si + <sup>65</sup>Cu @ 105 MeV, and <sup>30</sup>Si + <sup>65</sup>Cu @ 137 MeV) used in TIFR recently being ~ 40 – 60 ħ, we were not able to observe any further excited states [[Boh75](#), [Dat05](#), [Dat13](#)]. We want to point out that the intensity of the transitions depopulating the observed highest spin states in the current experiment is around 5 % of the channel strength, which is quite large and the array was sensitive enough to enable observation of transitions with intensities ~ 1 %. *This could possibly indicate a large change in structure of this nucleus at high-spin which may involve a highly fragmented decay path consisting of several weak high-energy gamma rays.* This suggests a complex fragmentation of the level scheme at high spin and poses experimental challenge for the identification of exotic shapes at high spin. Some of the experimental studies on high spin states in nuclei near A ~ 90 region using gamma-gamma coincidence measurements have already been carried out at PLF, Mumbai [[Sah12](#), [Sah14](#), [Sin14](#), [Sah19](#)]. With the addition of PARIS detectors for the measurement of high energy-gamma rays and newly developed CsI(Tl) array to

---

<sup>1</sup> Schedule may be affected due to adverse impact of the Covid-19

INGA, higher experimental sensitivity will be achieved. This improved setup is important to get new insight about the high spin behavior of the isotopes near  $^{90}\text{Zr}$ .

## 2. Study of the population of coexisting shapes in $A \sim 130$ region through high-energy gamma-ray measurements

Of particular interest are the isotopic chains of Nd and Sm, which show the transition from spherical shapes near  $N = 80$ , to  $\gamma$ -soft shapes, and then to prolate deformed energy surfaces in lighter isotopes. Around  $N = 74$ , the rapid change in deformation parameters has been noted. These nuclei are susceptible to large shape changes with appreciable quadrupole moments or coexistence of multiple shapes within a narrow range of excitation energies or both. A highly deformed rotational band at higher spins was also reported earlier in  $^{136}\text{Sm}$  [Bri98] and will be challenging to see if it decays preferably to the highly deformed minima at low spin [Xia18]. Recent study indicated triaxial shape after particle alignment in  $^{136}\text{Sm}$  [Bab19]. In similar excitation energy, a high-K isomer has been reported in  $^{136}\text{Sm}$  [Reg95], which suggests an axially symmetric shape. It will be important to study the population mechanism of different bands in  $^{136}\text{Sm}$  through high-energy gamma transitions measurements in coincidence with discrete gamma rays. Such investigation will provide new insight for understanding the evolution of nuclear shapes starting from the hot nuclear system to cold nuclear structures.

## 3. Jacobi shape transition

The study of Jacobi shape transition - an abrupt change of shape from non-collective oblate to collective triaxial/prolate, in quantum objects like rapidly rotating nuclei has attracted much attention. The Jacobi transition in a nucleus can be probed using the GDR gamma-rays, where the expected signature is a narrow low energy component  $\sim 10$  MeV, which arises due to the Coriolis splitting of the GDR vibration along the most elongated axis of the highly deformed nuclei, along with a broader component in the high energy region [Mye01]. The first observation of Jacobi shape transition in nuclei was reported in the  $A \sim 50$  region [Hab93, Maj04]. Recently, the GDR studies have been carried out in  $^{31}\text{P}$  ( $^{19}\text{F} + ^{12}\text{C}$ ) and  $^{28}\text{Si}$  ( $^{16}\text{O} + ^{12}\text{C}$ ) (self-conjugate  $\alpha$  nucleus) at similar excitation energy. The measured GDR spectrum in the decay of  $^{31}\text{P}$  shows a distinct low energy component around 10 MeV, which is a clear signature of Coriolis splitting in a highly deformed rotating nucleus [Dey18]. Interestingly, a self-conjugate  $\alpha$ -cluster nucleus  $^{28}\text{Si}$ , populated at similar initial excitation energy and angular momentum, exhibits a vastly different GDR line-shape. Even though the angular momentum of the compound nucleus  $^{28}\text{Si}$  is higher than the critical angular momentum required for the Jacobi shape transition, the GDR lineshape is akin to a prolate deformed nucleus with  $\beta \sim 0.6$ . Considering the present results for  $^{28}\text{Si}$  and similar observation recently reported in  $^{32}\text{S}$  [Pan17], it was proposed that the nuclear orbiting phenomenon exhibited by  $\alpha$ -cluster nuclei hinders the Jacobi shape transition. The present experimental results suggest a possibility to investigate the nuclear orbiting phenomenon using high-energy gamma rays as a probe. However, it is also important to incorporate isospin effects. The PARIS detector together with multiplicity filter will be used to further investigate Jacobi shape transitions in light nuclei.

Additionally, the PARIS with a segmented silicon detector can be used for study of electromagnetic transitions in  $^8\text{Be}$ , which is a stepping stone to understand alpha clustering in heavier self-conjugate  $4n$  nuclei [Boh75]. The first electromagnetic transition between the excited resonant states in  $^8\text{Be}$  ( $4^+$  and  $2^+$ ), was reported earlier [Dat05], which was followed by a more precise measurement [Dat13]. A measurement of more challenging  $2^+$  to  $0^+$  radiative transition in  $^8\text{Be}$  can really provide tests for different theoretical models. The intra-state E2 transitions can provide important insights into electromagnetic moments.



# PARIS at the FAIR/GSI facility

J. Gerl

on behalf of the collaborations using PARIS detectors at FAIR/GSI

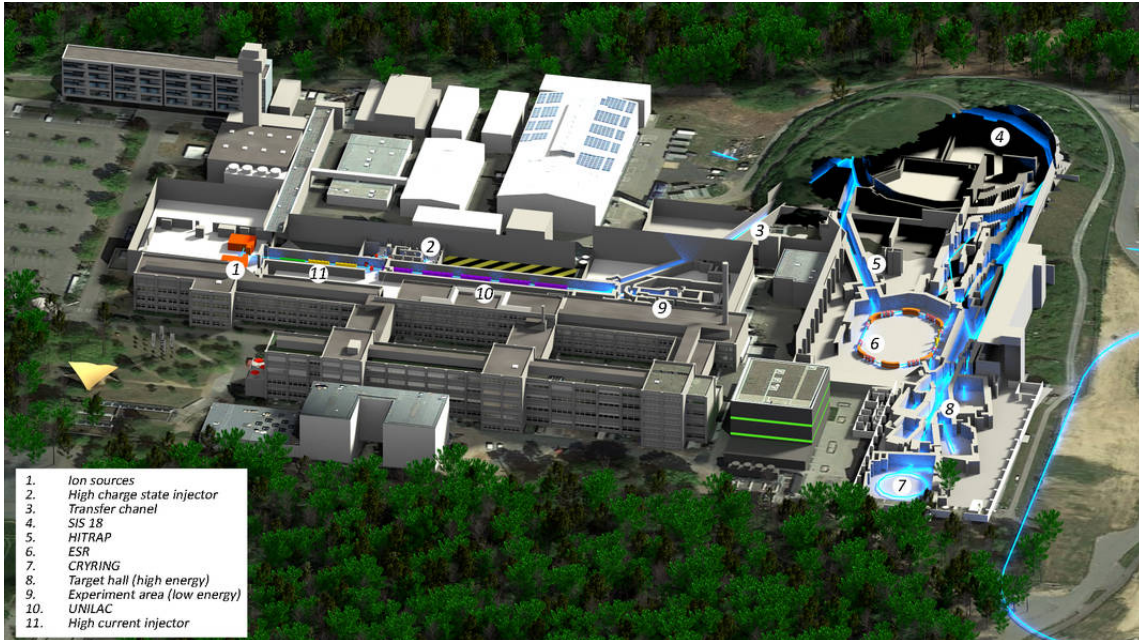

Figure 33. The GSI facility.

The GSI Helmholtzzentrum für Schwerionenforschung in Darmstadt operates a worldwide leading accelerator facility for research purposes. About 1,520 employees are working at GSI. In addition, every year approximately 1,000 researchers from universities and other research institutes around the world come to GSI to use the facility for experiments.

The main focus of the GSI research program is the basic investigation of the field of nuclear physics and atomic physics. In parallel, application-oriented research activities in materials research, plasma physics, biophysics and nuclear medicine were developed. To supply state-of-the-art facilities for science, the accelerator facilities and the experiment facilities are permanently being enhanced and improved. One important topic of nuclear physics is the study of the properties of exotic nuclei - nuclei with extreme numbers of protons or neutrons - which lead to new insights on the origin of chemical elements in stars and star explosions.

Exotic nuclei are produced by fragmentation and fission of heavy ions at relativistic energies available from the SIS18 synchrotron. Selection and purification of these secondary beams is achieved by the four-stage fragment separator FRS. FRS beams are used with dedicated experimental set-ups to perform reaction studies and nuclear spectroscopy.

At GSI, FAIR is currently being built, an international accelerator facility for the research with antiprotons and ions, which is being developed and constructed in cooperation with international partners. It is one of the world's largest construction projects for international cutting-edge research. The FAIR project was initiated by the scientific community and researchers of GSI. The GSI accelerators will become part of the future FAIR facility and serve as the first acceleration stage.



Figure 34. The FAIR facility currently under construction.

For the realization of FAIR the FAIR GmbH, an international company under German law, was founded. The shareholders of FAIR come from nine countries: Finland, France, Germany, India, Poland, Romania, Russia, Slovenia, Sweden. The United Kingdom is associated. At FAIR, matter that usually only exists in the depth of space will be produced in a lab for research. Scientists from all over the world will be able to gain new insights into the structure of matter and the evolution of the universe from the Big Bang to the present.

FAIR will be one of the largest and most complex accelerator facilities in the world. The FAIR accelerator facility will have the unique ability to provide particle beams of all the chemical elements (or their ions), as well as antiprotons. The particles will be accelerated to almost the speed of light in the FAIR accelerator facility and made available for scientific experiments. FAIR will generate particle beams of a previously unparalleled intensity and quality. At the heart of the facility is an underground ring accelerator with a circumference of 1,100 meters. There are also additional experimental rings and experimental stations with several kilometres of beam lines in total.

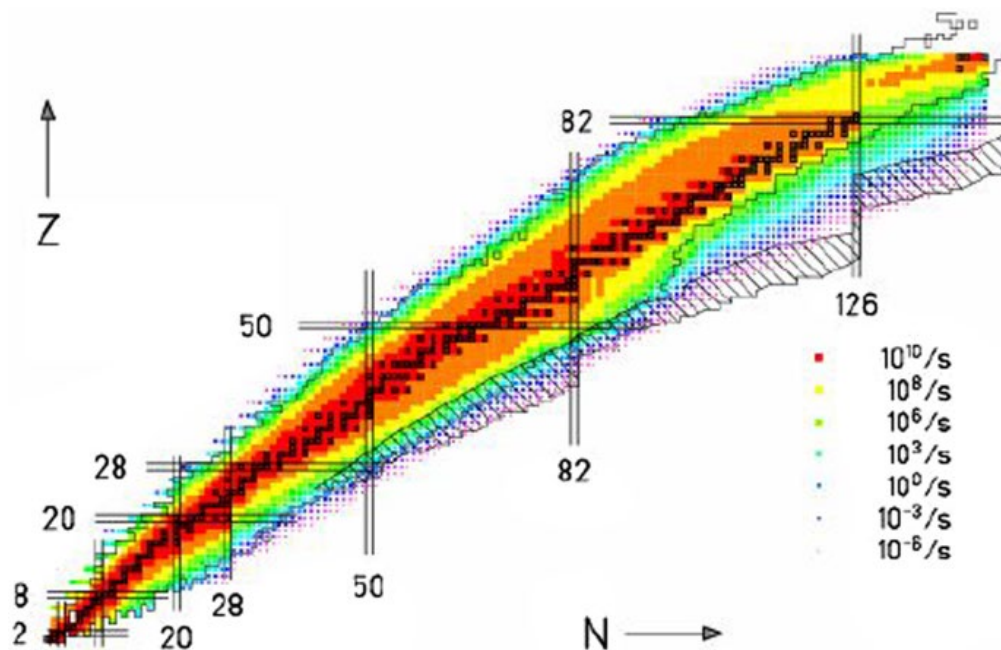

Figure 35. Production yields of isotopes at the Super-FRS.

A six-stage superconducting fragment separator, Super-FRS, will serve the nuclear structure community with secondary beams of rare isotopes with up to 4 orders of magnitude higher beam intensity as compared to the current beams at FRS and unprecedented purity. To take advantage of these beams the NUSTAR collaboration was founded, constituting the largest of the four FAIR research pillars. NUSTAR has about 900 members from institutions from all over the world. Different sub-collaborations concentrate on specific research aspects. The sub-project HISPEC/DESPEC deals with in-beam and decay spectroscopy using the exotic beams of the Super-FRS.

### The use of PARIS at GSI/FAIR

State-of-the-art experimental set-ups, optimized for highest sensitivity and selectivity, have been developed and will be available for spectroscopic studies of exotic isotopes. Until the FAIR facility becomes operational with its Phase-1 in the mid-20s, FAIR Phase-0 experiments will make use of the FRS at GSI. Depending on the abundance of the produced exotic isotopes, different experimental methods can be applied, enabling different physics goals.

	Experimental method (beam-energy range)	Physics goals and observables	Beam int. (particle/s)
HISPEC	Intermediate energy Coulomb excitation, In-beam spectroscopy of fragmentation products (E/A ~ 100 MeV)	Medium spin structure, Evolution of shell structure and nuclear shapes, transition probabilities, moments,	$10^1 \dots 10^5$
	Multiple Coulomb excitation, direct and deep-inelastic, fusion evaporation reactions (E/A ~ 5 MeV; Coulomb barrier)	high spin structure, single particle structure, dynamical properties, transition probabilities, moments,	$10^4 \dots 10^7$
DESPEC	Decay spectroscopy (E/A = 0 MeV)	half-lives, spins, nuclear moments, GT strength, isomer decay, beta-decay, beta-delayed neutron emission, exotic decays such as two proton, two neutron.	$10^{-5} \dots 10^3$

Figure 36. Physics reach of HISPEC/DESPEC at GSI/FAIR.

#### DESPEC - Decay Spectroscopy

The key instrument for decay spectroscopy of exotic nuclei is the active implanter AIDA. AIDA consist of a stack of highly segmented double-sided Si strip detectors covering the full focal plane of FRS/Super-FRS. It provides an effective granularity of about 10000 for the detection of ion implants and their respective alpha, beta, or fission decay. Plastic detectors for fast timing applications complement AIDA.

For lifetime measurements of gamma-decaying transitions, the fast-timing array FATIMA is used. FATIMA in its current version consist of 36 LaBr<sub>3</sub> scintillators with a total efficiency at 1.3 MeV gamma energy of 3 % and a time resolution of about 250 ps (FWHM).

For high-resolution gamma-spectroscopy the DEGAS HPGe array has been developed. DEGAS detector units are composed of three encapsulated EUROBALL Ge crystals. Due to a special low-loss cryostat, this triple detector can be electrically cooled. This enables very compact set-ups with up to 18 % efficiency. Sub-arrays can also be realized. For instance, for experiments to be



performed in 2021 a hybrid set-up with 12 DEGAS units (7 % efficiency) and the full FATIMA array is being planned.

A total absorption gamma spectrometer DTAS is also available. It is built in a modular geometry from 18 large volume NaI(Tl) detectors. The full-energy efficiency is about 60 %, with an energy resolution of 6 %.

Finally, a  $4\pi$  neutron detector BELEN with  $^3\text{He}$  counters and a modular neutron T.O.F. spectrometer MONSTER is also available for DESPEC experiments.

All these detector systems are operated with their individual EDAQ systems coupled by the White Rabbit time stamp system to a very flexible data acquisition system.

PARIS detectors ideally add to these building blocks, whenever detection of high-energy gamma rays is needed. Moreover, PARIS detectors with their superior energy resolution will be employed to further improve the response of the DTAS spectrometer. Here, an equatorial PARIS detector belt is envisaged. Finally, in hybrid set-ups with DEGAS sub-arrays, PARIS detectors provide excellent timing properties and ultimate efficiency also for lower gamma energies. Therefore spectroscopic sum-energy/multiplicity filters can be realized, boosting the sensitivity for rare decay events.

### **HISPEC - In-beam Spectroscopy**

Key instrument for in-beam studies with exotic isotopes at relativistic energies is the HPGe tracking array AGATA. AGATA in 2-3  $\pi$  configurations is planned to be used once FAIR Phase-1 starts, i.e., at the FAIR facility. For the identification and tracking of the outgoing heavy reaction partner, after the secondary target, the position-sensitive  $\Delta E$ -E calorimeter LYCCA is foreseen. Contrary to the first realization of this set-up at the FRS in 2012-2014, the new set-up will in addition comprise of a dipole magnet stage for an improved mass selectivity.

Besides Coulomb excitation and secondary fragmentation reactions at energies  $\geq 100$  MeV/u, the project DESPEC-10 aims at target energies close to the Coulomb barrier to enable all kinds of classical reaction types for spectroscopic studies. Like at relativistic energies, the principle idea is to identify and track each beam particle event-by-event employing fast, high-rate particle detectors.

The suite of available instruments will also comprise active gas and solid-state targets, a light particle detector array and a plunger.

Any detector system can be easily included with their individual EDAQ by time stamping as mention before.

PARIS detectors will complement the set-ups whenever high-energy gamma efficiency and/or superior timing properties are wanted. The setups with AGATA will resemble the ones employed at GANIL.

## **Physics with PARIS at GSI/FAIR**

HISPEC/DESPEC at GSI/FAIR will address nuclear structure and astrophysics questions using radioactive beams delivered by the Super-FRS with energies of up to 400 AMeV at the secondary target for reaction studies or stopped and implanted beam species for decay studies. The emphasis lies on medium heavy and heavy systems with exotic proton-to-neutron ratios. The project focuses on those aspects of nuclear investigations which can be uniquely addressed with high-resolution spectroscopy setups.

Such methodologically comprehensive studies will provide unprecedented and unique information on the so far unreachable  $N = 126$   $r$ -process path. The direct measurement of the key ingredient of the  $r$ -process, such as lifetimes,  $Q$ -values and delayed neutron-emission probabilities, will be used to constrain models of astrophysical environments in which the  $r$ -process takes place. Experiments providing the level schemes of these nuclei will be used to understand the physics and the origin of or lack of shell evolution. The theoretical understanding is essential, as it will provide robust predictions for even more neutron-rich nuclei, including those  $N = 126$   $r$ -process path nuclei which cannot be reached even at FAIR.

Other examples of anticipated “day-1” experiments, addressing questions like shell evolution towards the extremes of nuclear existence, transition from single-particle to collective motion in extremely neutron-rich matter, symmetries, and nuclear astrophysics, are:

- $rp$ -process studies;
- shape evolution in the  $Z = 72-78$  region,  $K$ -isomers, neutron decay;
- isospin symmetry along the  $N = Z$  line, in conjunction with proton-emitting ground or isomeric states below tin,  $Z = 50$ ;
- $^{100}\text{Sn}$  region;
- shape evolution for, e.g.,  $^{110}\text{Zr} \rightarrow ^{122}\text{Zr}$ ;
- $N \sim 82$  shell evolution and  $r$ -process;
- shape evolution above lead, neutron deficient side;
- proton radioactivity in trans-lead isotopes;
- beta-delayed fission;
- heavy neutron-rich nuclei between Pb and U;
- fine structure of (new) collective modes of neutron-rich matter.

As indicated above PARIS detectors will play an important role for a broad variety of these experiments as PARIS may increase both the sensitivity and the selectivity of the set-ups considerably. This holds for general spectroscopy as well as for timing measurements.

One particular aspect of PARIS is its unique high-energy gamma efficiency. A prominent example is the detection of the gamma decay of high-energy levels, i.e. giant and pygmy resonance states, particularly well populated in one-step Coulomb excitation. Very little is known about the fine structure of these states throughout the nuclear chart. This important aspect of nuclear structure alone justifies a campaign of PARIS experiments at GSI/FAIR.

## PARIS at JINR

*Yu.E. Penionzhkevich, Yu.G. Sobolev*

*Flerov Laboratory of Nuclear Reaction, JINR, 141980, Dubna, Russia*

### Main Collaborating institutions:

IFJ PAN Kraków, GANIL Caen and the PARIS collaboration

### The FLNR JINR facility and available beams

The Flerov Laboratory of Nuclear Reactions of the Joint Institute for Nuclear Research at Dubna Russia (FLNR JINR) is one of the largest and leading laboratories in the world engaged in research using ion beams. The main activity of the FLNR is fundamental nuclear physics.

At present, there are three cyclotrons in operation: **DC280**, **U400**, **IC100** and the **MT-25** microtron, which ensure the implementation of fundamental and applied research at the FLNR JINR (see Fig. 37). Two cyclotrons, **U400M** and **U200**, are in a reconstruction phase.



**Figure 37. The layout of the Flerov Laboratory buildings. The U400, U400M, IC100, DC280 are heavy ion cyclotrons, MT25 is the microtron, SHE Factory is the Super Heavy Element Factory, NC is the Nanotechnology Centre.**

The **DC-280 cyclotron** ( $D = 4$  m) is the basic facility of the Super Heavy Element Factory (SHE factory), it is able to accelerate ions with energies 4 – 8 MeV/u at intensities up to 10 pA for ion masses over  $A = 50$ . The main task of the Factory is the synthesis of new chemical elements with atomic number  $Z = 119$  and higher, as well as a detailed study of the nuclear and chemical properties of previously discovered super-heavy elements.

The **U400 cyclotron** ( $D = 4$  m) was designed to accelerate ions from B to Bi up to 19 MeV/u. The reconstruction of U400 cyclotron is planned.

The **IC100 accelerator** ( $D = 1$  m) is used for applied researches with Ar, Kr, Xe and other heavy elements of the Periodic Table with  $A/Z = 5.54 - 5.95$  at energies of 0.9 – 1.1 MeV/u.

The construction of the **DC-130 cyclotron** ( $D = 2$  m) with ion energies of 4.5 and 2 MeV/u is planned on the location of the old U200 cyclotron.

The **U400M cyclotron** ( $D = 4$  m) is in a modernization phase. Before the modernization the cyclotron was intended to accelerate ion beams from Li to Bi with  $A/Z = 3 - 3.6$  (being  $A$  the atomic mass of the accelerated ion and  $Z$  the ion charge when accelerated) at energies of 34 – 60 MeV/nucleon, and ion beams with  $A/Z = 8 - 10$  at energies of 4.5 – 9 MeV/nucleon.

The U400M has two opposite directions of ion extraction with corresponding ion beam transport lines, respectively. As a result of the modernization, we expect to increase intensities and maximal energies of ion beams. It would be possible to increase energies of light ions to 60 – 80 MeV/nucleon by using an electrostatic deflector for ion extraction from ultimate cyclotron radiuses. The details of the accelerator complex of the FLNR are published in [[Gul11](#), [Gul95](#), [Bog14](#), [Gul16](#), [Kal18](#)].

## The use of PARIS at FLNR

In 2020, 9 PARIS phoswich detectors (one cluster) were coupled to the MULTI 4 $\pi$  gamma array at FLNR, JINR. The first experiment is planned to be performed with  $^{18}\text{O}$  beam in the first half of 2021. There are also other ideas to use PARIS cluster & MULTI 4 $\pi$  array coupled to the ACCULINNA fragment separator. This project is aimed to study new types of decay of exotic nuclei, precisely  $\beta$ -decay through soft dipole resonances (pygmy resonances) and multi-neutron decay. In the framework of this project, beams of radioactive oxygen nuclei ( $A = 20, 22, 24$ , in the region of  $N = 16, 20$  shells) will be produced at the accelerator U-400M FLNR JINR and delivered to the ACCULINNA fragment-separator.

## Experimental equipment

The setup of the PARIS cluster combined with MULTI 4 $\pi$  array was prepared at FLNR JINR specially for studying reactions with neutron rich isotopes of light nuclei. It consists of 30  $^3\text{He}$ -counters of neutrons and the PARIS cluster, together with 12 CsI(Tl) MULTI 4 $\pi$  gamma array [[Siv20](#)]. A combination of unique beams of radioactive nuclei and the highly efficient 4 $\pi$  n- $\gamma$ - $\beta$ -spectrometer will provide new important information on decay properties of exotic nuclei near the border of neutron stability (for oxygen isotopes).

## Electronics

The electronics for the PARIS+MULTI 4 $\pi$  gamma array are based on the VME DAQ system equipped VME Mesytec units (MADC-32, MQDC-32, MTDC-32, MDPP-16). In the future we are going to update the VME DAQ system to the fully digital electronics (it may be the CAEN V1730 digitizers).

## Physics Cases

Significant interest, in terms of studying pygmy resonances and their effect on astrophysical processes associated with  $\beta$ -decay, represent neutron-rich oxygen isotopes in the mass region  $A \approx 18 - 24$ . For nuclei in this region, a new neutron magic number  $N = 16$ , was discovered, on the basis of systematics of neutron separation energy and reaction cross sections. In addition, calculations using the Glauber model, concluded that at large values of  $T_z$ , the valence neutron is more likely to occupy the  $2s_{1/2}$ -orbit. The proposed single-particle structure in the  $N = 16$  nuclei, together with the observed behavior of  $\sigma_1$  and  $S_n$ , were explained by the influence of a new  $N = 16$  magic number near the neutron stability line. The presence of this magic number probably originated from the halo-structure in the corresponding nuclei. Thus, the  $N = 16$  neutron number is a new magic number, and the corresponding nuclei are spherical.

These conclusions are consistent with the calculations performed within the shell model framework in which the large energy gap between the  $2s_{1/2}$  and  $1d_{3/2}$  orbitals was obtained for the nuclei in the discussed region at  $N = 16$ . As an example, one can consider  $^{20}\text{C}$  and  $^{22}\text{O}$ . For isotopes of carbon and oxygen up to  $N = 12$ ,  $E_{2^+}$  energies are close. This is due to the influence of the  $(d_{5/2}) J = 2$  configuration at  $Z = 6$  and  $Z = 8$ . However, at  $N = 14$ , the energy of the  $2^+$  state in the  $^{20}\text{C}$  nucleus is almost 2 times lower than in  $^{22}\text{O}$ . Since the energy of the first  $2^+$  excited in  $^{22}\text{O}$  is 3.19 MeV and it is greater than the one for lighter oxygen, at  $N = 10$  and 12, one can assume that

in oxygen a N = 14 sub-shell effects will appear. Thus, the detailed studies of decay properties and nuclear structure of neutron-rich oxygen isotopes will drive to an explanation of the so-called “oxygen anomaly” associated with the manifestation of the new N = 16 neutron magic number and the possible sub-shell of N = 14.

Methodologically, in order to obtain complete information about the decay properties of exotic oxygen nuclei, one has to produce them with a relatively high yields, and one has to be able to measure simultaneously gamma and neutron radiation accompanying their beta-decay. The choice of a specific reaction to produce them will be done after measurements of experimental yields in different reactions (transfer reactions, fragmentation) at the U400 cyclotron of FLNR JINR, using the MAVR [Mas16] magnetic analyzer. These studies will be carried out at the first stage of the present project. At the same time the theoretical studies using the self-consistent microscopic models will provide necessary inside view on the structure of light nuclei and, precisely, the properties of Pygmy Dipole Resonance and the process of nucleon clustering in light nuclei.

The list of physics cases planned to be studied with the PARIS+MULTI 4 $\pi$  gamma array (after 2022 renovation of the U-400M accelerator) is:

1. High-energy gammas in  $^{18}\text{O}$  induced reactions (inelastic scattering, neutron-transfer,...) - Yu. Sobolev, S. Stukalov et al.
2. Total reaction cross section studies of  $^{18-24}\text{O}+^{28}\text{Si}, ^{59}\text{Co}, ^{181}\text{Ta}$  reactions by 4 $\pi$  gamma technique with PARIS & MULTI 4 $\pi$  gamma array - S. Stukalov, Yu. Sobolev et al.
3. High-energy gammas of  $^{18}\text{O}$  in  $\beta$ -decay of  $^{18}\text{N}$  - Yu. Sobolev, S. Stukalov et al.
4. PDR measurements with PARIS+MULTI & ACCULINNA at JINR - Yu. Penionzhkevich et al.

**1. High-energy gammas of  $^{18}\text{O}$  induced reactions (inelastic scattering, neutron-transfer,...)**

are proposed to be measured at the CORSET beam-line @U400 cyclotron. Gamma rays will be measured by the PARIS CeBr<sub>3</sub>-NaI(Tl) clusters in coincidence with charged particles emitted at the forward angles. The measured yields of  $^{16-22}\text{O}$  products in  $^{181}\text{Ta}(^{18}\text{O}, ^{16-22}\text{O})\text{X}$  reaction at  $\Theta_{\text{LAB}} = 12^\circ$  are presented in Tab.1 from [Azh20]. A scheme of the experiment and a photo of the CeBr<sub>3</sub>-NaI(Tl) cluster are in Fig. 38.

<u>Table 1.</u> Differential cross sections of $^{16-22}\text{O}$ products of $^{18}\text{O}$ ( $E = 10 \text{ A MeV}$ ) + $^{181}\text{Ta}$ reaction [Sob19]						
	$^{16}\text{O}$	$^{17}\text{O}$	$^{19}\text{O}$	$^{20}\text{O}$	$^{21}\text{O}$	$^{22}\text{O}$
$d\sigma/d\Omega$ [mb/sr]	0.899	0.465	0.309	0.048	0.005	0.001
$\Delta\sigma/\sigma$	0.123	0.108	0.223	0.231	0.23	0.227

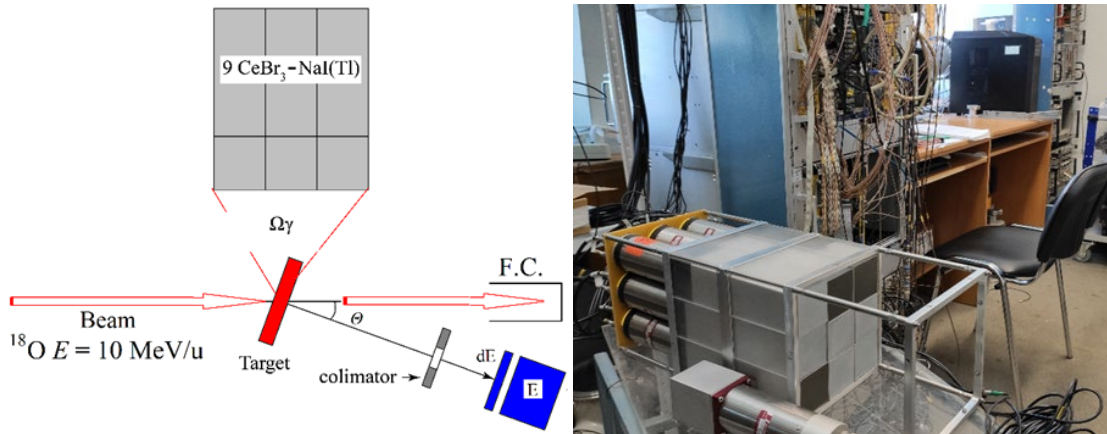

Figure 38. (Left) Scheme of the high-energy gammas of  $^{18}\text{O}$  induced reaction experiment with PARIS phoswich clusters; (Right) Photo of 9  $\text{CeBr}_3\text{-NaI(Tl)}$  phoswich detectors with DAQ VME based system.

## 2. Total reaction cross section studies of $^{18-24}\text{O}+^{28}\text{Si}$ , $^{59}\text{Co}$ , $^{181}\text{Ta}$ reactions by $4\pi$ gamma technique with PARIS & MULTI $4\pi$ gamma array.

Research on the structure of light exotic nuclei that lie at the boundary of the region of stability and specific features of their reactions by total reaction cross section measurements is an important topic of today's nuclear physics. The unusual nature of light neutron-rich nuclei with halo is apparent from their surprisingly large reaction cross sections and specific peculiarities of  $\sigma_R$  energy dependences [Sob12a, Sob12b, Pen19, Sob19, Sob20].

The distributions over the number of triggered detectors of a segmented MULTI  $4\pi$ + PARIS array will be measured for the events of  $^{18-24}\text{O}+^{28}\text{Si}$ ,  $^{59}\text{Co}$ ,  $^{181}\text{Ta}$  reactions. The total reaction cross sections  $\sigma_R(E)$  will be obtained using the method of registration of neutrons and  $\gamma$ -quanta, based on the measured response function of the  $\gamma$ -spectrometer [Sob19, Sob20] and experimental distributions over the number of triggered detectors for each particle beam energy, and the distribution function over the multiplicities of emission of  $\gamma$ -quanta and neutrons.

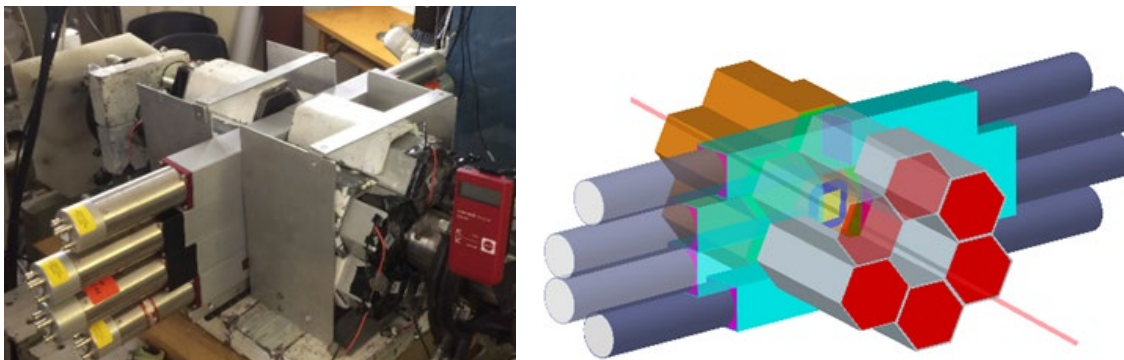

Figure 39. Photo and scheme of segmented MULTI & PARIS  $4\pi$   $\gamma$ -spectrometer (12  $\text{CsI(Tl)}$  & of 8  $\text{CeBr}_3\text{-NaI(Tl)}$  phoswich) installed in the low-background ACCULINNA cave @ U400M cyclotron.

The data will be processed taking into account the experimental values of the efficiency gamma-rays with different multiplicities and the number of triggered detectors. In combination with the method of data processing described in [Sob19, Sob20], the measurement technique with the registration of prompt neutron and gamma radiation by a segmented spectrometer with several scintillation detectors extends the capabilities of the method of registration of neutrons and gamma rays for measuring total reaction cross sections. It also allows to obtain the distribution function over the multiplicity of emission of gamma rays and neutrons in the selected reaction channels.



### 3. and 4. High-energy gammas of $^{18}\text{O}$ in $\beta$ -decay of $^{18}\text{N}$ and PDR measurements with PARIS+MULTI & ACCULINNA at JINR.

The nature of the excitation mechanism of the “soft” GDR mode is still unclear. The studies of the “soft” modes in nuclei around the oxygen region will allow to draw a conclusion on the presence of halo structure and its influence on decay properties of these nuclei. It is expected that the soft dipole resonance should manifest itself in the structure of halo nuclei as a low-lying dipole level. As the neutron excess increases it is luckily that the large N/Z ration will significantly impact the properties of giant resonances and low-lying collective states.

Reactions of nucleon transfer and fragmentation will be used to assess secondary beams of radioactive nuclei. Thus, it is supposed to produce neutron-rich oxygen nuclei with mass A=20, 22 and 24 at a relatively high yield. For this purpose, the fragment-separator ACCULINNA [Rod03, Fom08, Fom10, Fom12] will be used. The nuclear decay properties will be measured at the  $4\pi$  multi-detector array MULTI consisting of 12 CsI(Tl) scintillator detectors, 34  $^3\text{He}$  neutron counters, 1 PARIS CeBr<sub>3</sub>-NaI(Tl) cluster for detection of the gamma radiation in coincidence with the Si- $\beta$  detector (see Fig. 40). MULTI will allow high efficiency for simultaneous detection of beta-, alpha- and neutrons. In addition, the high granularity of gamma and neutron detectors allows for measurement of gamma and neutron multiplicity with high resolution and determination of angular correlation of emitted neutrons, which will provide information on neutron clusters formed in the process of  $\beta$  decay. Thus, the proposed experimental method combining RIB at high intensity and the  $4\pi$ -geometry multi-detector MULTI array, will allow to successfully achieve, at a high scientific level, all the aims stated.

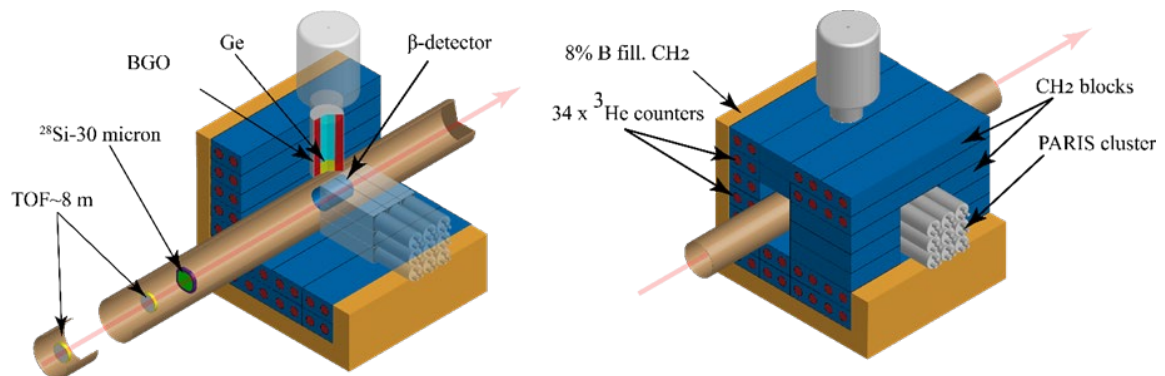

Figure 40. Scheme of set-up for high-energy gamma of  $^{18}\text{O}$  in  $\beta$ -decay of  $^{18}\text{N}$  and PDR measurements with PARIS+MULTI & ACCULINNA at JINR.



## The path towards a PARIS MINICUBE and some examples of Physics Cases

The physics cases presented in the previous chapters assumed that 8 clusters of PARIS (namely 72 phoswiches) will be available. However, for most of the already presented cases, one could expect a large improvement in the quality of the results if the number of the available clusters would increase significantly (for example up to 16 clusters, which corresponds to 144 phoswich detectors). In fact, at first order, the full energy peak efficiency and the array granularity scale with the phoswich number (at a fixed target to detector distance) and will be ca. 8 % at 10 MeV at 25 cm distance from the target.

Because of the modularity of the PARIS array, if the phoswich number is large enough, one can think about geometries which could be optimized for specific physics cases. In the situation that 150 phoswiches (which is equivalent to 16 clusters plus 6 phoswiches) are available, a “compact”  $4\pi$  geometry could be built keeping the target-to-detector distance between 17 – 20 cm. It is not possible to build such a geometry with less detectors without significantly reducing the target-to-detector distance. This geometry could consist in 6 super-clusters, each having 25 phoswiches arranged in a  $5 \times 5$  matrix (see Fig. 41). Considering the good timing resolution of PARIS, it will still be possible to separate most of the target emitted neutrons from gamma rays using the Time of Flight (ToF) technique, in spite of the short 17 – 20 cm target-to-detector distance. In addition, in case of high multiplicity  $\gamma$  events, the probability that two different  $\gamma$ -rays will interact in the same detector is still very small.

A ‘compact’  $4\pi$  geometry can be considered as the next goal for the PARIS array. A  $4\pi$  geometry will allow to propose a number of new physics cases (few examples are listed in this chapter) which couldn’t be considered before because of the lack of granularity and/or incomplete information on the sum-energy observable. This ‘compact’  $4\pi$  solution also guarantees a much better absolute full energy peak efficiency. For example, at 10 MeV the absolute full energy peak efficiency of the ‘compact’  $4\pi$  minicube geometry is expected to be 20% at 10 MeV (see Fig. 42). In addition, due to the increased multiplicity resolution, one will be able to select cases with gamma-multiplicity equal to 1, which is very important, for example, in studying the one-step decay of the GDR or PDR. A disadvantage of this ‘compact’ geometry is a reduced distance from target. This means, if compared with the large  $4\pi$ -cube solution of 24 clusters (shown in Fig. 1 in the Introduction), a somewhat limited reduction of the Doppler Broadening effect, a limited gamma-neutron rejection and a higher probability that two different gamma rays enter in a single phoswich.

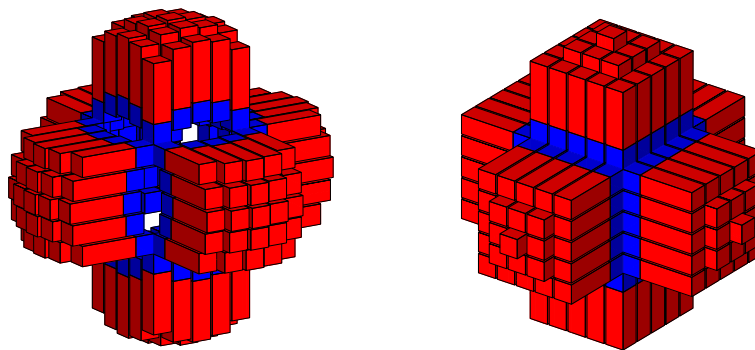

Figure 41. Two different  $4\pi$  geometries for the PARIS array which can be created using 150 phoswiches. Left: the “equidistant” minicube, with  $d = 20$  cm. Right: the “compact” minicube, with the target to detector distance between 17.8 to 20 cm.

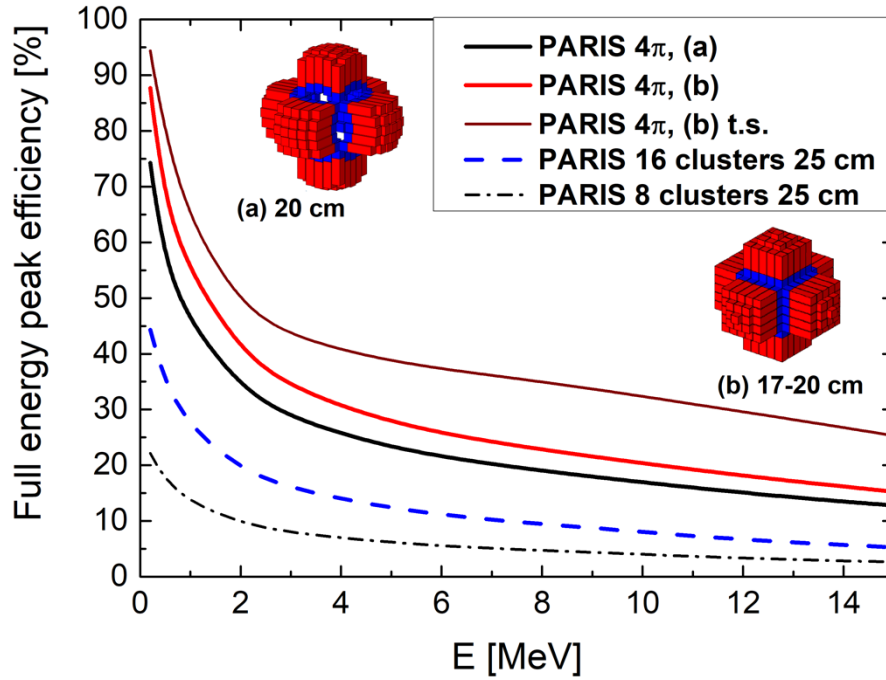

Figure 42. The absolute full energy peak efficiency curves for different geometries or sizes of the PARIS array. Using a detector to target distance of 25 cm, the efficiency is indicated with the black dot dashed line, for an array composed of 8 clusters, and with the blue dashed line, for an array composed of 16 clusters. The efficiency of the two small cube geometries is indicated with the red and black lines. The brown line indicates the efficiency for the ‘compact’  $4\pi$  geometry of PARIS (geometry ‘b’) in the case the PARIS array is used in ‘total sum’ mode, namely, supposing that only one gamma ray is emitted from the target and summing the energy deposited in all the phoswiches [Cie21]. Obviously, the curves shown represent the maximal possible efficiencies as calculations do not include all possible losses due to details of the mechanical frame.

### A. Some examples of topics which would benefit from having 16 clusters

If the number of available detectors is at least doubled (namely 16 cluster, each composed of 9 phoswiches), all topics discussed in detail in the previous chapters would significantly improve the quality of their results. In particular, if 16 clusters will be available, PARIS will cover a solid angle close to  $2\pi$  using a target-to-detector distance of 25 cm. This leaves approximately  $2\pi$  for other detectors, as for example AGATA- $2\pi$ , VAMOS, FAZIA, etc., giving the possibility to measure, with high efficiency, high energy gamma rays in coincidence with low energy ones (detected, for example, by a HPGe array), or in coincidence with a specific nuclear species or with specific charged particles. At the moment, these types of coincidences are, in general, very difficult, because of lack of efficiency. As examples, topics like the study of Giant and Pygmy Dipole Resonances, mentioned in the previous chapters and briefly recalled here below, will strongly profit of such type of setup.

#### 1. Studies of the Giant Dipole Resonances

The Isovector Giant Dipole Resonance (GDR) is an out of phase oscillation of the proton against the neutrons (see Fig. 43). The GDR strength function has a centroid between 10 to 20 MeV and a FWHM which could span from 5 to 15 MeV. It is well known that it couples to the nuclear shape and that it can be used to study the evolution of the nuclear shape as the angular momentum and excitation energy change. The typical reaction mechanism which is used to excite the GDR is a fusion-evaporation reaction, but it has also been populated using inelastic scattering, fusion-fission and incomplete fusion reactions. The gamma decay of the GDR is composed by E1 radiation

with energy between 5 to 25 MeV. The GDR is frequently used as a probe for the studies of various aspects of nuclear structure and dynamics (e.g., the Isospin Mixing phenomenon; the Jacobi shape transition; the feeding of super-deformed structures; shape evolution with temperature and angular momentum). As mentioned in the previous chapters of this White Book, there are several physics cases (see for example ALTO-1, CCB-1, CCB-5, LNL-1, LNL-4, LNL-5, LNL-6, LNL-11, PLF-3), dedicated to the measurement of the gamma decay of the GDR, which could profit of an enhancement in the efficiency of the PARIS array.

## 2. Studies of the Pygmy Dipole Resonances

The Pygmy Dipole Resonance (PDR) is the oscillation of the external neutrons (perhaps also of the external protons, although there is not a clear experimental evidence, at the moment) against an ‘inert’ core. It can obviously be excited in neutron rich nuclei (usually exotic nuclei, like for example  $^{68}\text{Ni}$ ) using inelastic scattering reactions in inverse kinematics. Recently, the PDR states have been populated also through the  $\beta$  decay. The PDR strength function has a centroid located around the particle binding energy and it can be excited using an isoscalar or an isovector probe. In general, it has been observed that the nuclear states populated using an isoscalar probe (i.e., scattering on alphas) are located a little lower in energy if compared with the nuclear states populated using an isovector probe (i.e., scattering on protons). It is not clear if the PDR couples to the nuclear shape, if it splits because of the nuclear deformations, and its behavior with nuclear temperature and angular momentum has not been investigated yet. As previously mentioned, in this White Book there are several physics cases (see for example GANIL-3, ALTO-7, LNL-2, LNL-3, LNL-2A, JINR-3), dedicated to the measurement of the gamma decay of the PDR, which could significantly improve the quality of their results if a larger PARIS array would be available.

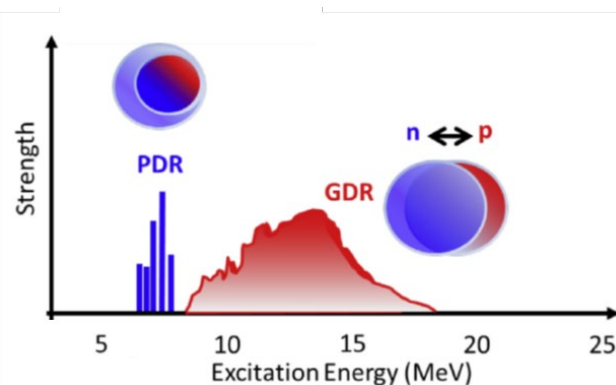

Figure 43. Pictorial view of the GDR and PDR collective excitations (adapted from [Bra19]).

### B. New physics cases for the $4\pi$ -minicube (6 super-clusters, 25 phoswiches each)

In the case of PARIS being composed of 150 phoswiches, grouped in 6 super-clusters  $5 \times 5$ , it can be arranged in a small cube covering practically the whole  $4\pi$  solid angle. In the following, we list some additional topics which could be accessible with the  $4\pi$  geometry. Some were already proposed in different PARIS LOIs and reports (see, for example, the documents available at the PARIS web page (<http://paris.ifj.edu.pl/>)).

#### 1. Experimental mapping of the T-J phase space of the atomic nucleus

The atomic nucleus represents a very fine laboratory to study the dynamics of a correlated quantum many-body system. The structural evolution of such a system with temperature (T) and angular momentum (J) provides a very rich spectrum of excitation modes and corresponding shape-phase transitions. The variety of shapes and phase transitions that a nucleus undergoes, while traversing the T-J landscape, are manifestations of the dynamics of a quantum many-body

system and transcends the confines of nuclear physics. While phenomenological calculations can predict such shape-phase transitions [Goo96], it is important to experimentally map the landscape with as fine precision as possible. This has not been accomplished so far.

Most of the nuclei are intrinsically deformed in their ground-states, due to quantum shell effects. The thermal excitation washes away both pairing and shell effects leading to a spherical shape. Therefore, in rotating hot nuclei, the shape is mainly due to the interplay between nuclear temperature and angular momentum effects. This may lead to the situation to have coexisting different shapes and spin orientations in the T-J (Temperature vs Angular Momentum) diagram (see Fig. 44). This is a very challenging experimental problem and demands sampling the Giant Dipole Resonance (GDR) gamma-rays from very small domains of T-J, in order to search for shape phase transitions. Narrowing down the search in angular momentum (J) space demands a very efficient spin spectrometer with adequate granularity for precision transformation of experimental fold to spin. An array of around 150 PARIS phoswich detectors covering  $4\pi$  solid angle will be ideal for precision measurement of very fine angular momentum gated by high energy GDR gamma-rays. On the other hand, the selection of narrow window in the T space is eminently possible by applying the differential technique [Maj92]. This very powerful technique produces two neighboring compound nuclei (A and A-1) via different reactions, with excitation energies differing by the separation energy of one neutron. Subtraction of the gamma-ray spectrum of A-1 from that of A generates the gamma-ray spectrum only from the decay of the compound nucleus A. This reduces the T window to only the energy loss of the beam in the target. Thus, the differential technique in conjunction with the  $4\pi$  spin spectrometer can extract GDR gamma-rays from a very narrow domain of T and angular momentum. Beside its line shape, the angular anisotropy of GDR gamma-rays provides a clear signature of the nature of the nuclear deformation and type of rotation (collective or non-collective). The extraction of the exact nature of the nuclear deformation from the angular anisotropy of GDR gamma-ray spectra is not dependent upon statistical model calculations. A  $4\pi$  configuration of the PARIS array can provide very precise angular distribution data. Considering all these arguments, a compact  $4\pi$  array of PARIS will be a very powerful device to explore the nuclear phase-space landscape at finite temperature and angular momentum. The Fig. 44 provides an artist's view of the scenario for a typical nucleus with different-dependent critical temperatures.

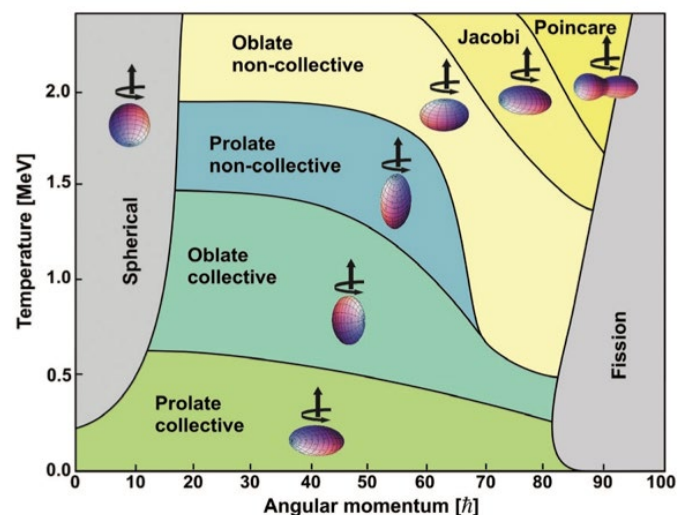

Figure 44. A typical phase diagram plot for the atomic nucleus showing regions of different shapes which coexist (adapted from [LRP2010]).

## 2. Search for the nuclear Poincare shape transition

In general, the nuclear temperature makes the shell effects gradually decrease and vanish. Therefore, one can describe macroscopic features of a nucleus, like its shape, using a classical approach. In this approach the interplay between the centrifugal, the Coriolis, the Coulomb forces together with the surface tension induces two types of instabilities: i) the *Jacobi shape transition*, a rapid shape change from oblate to elongated prolate (a physic case is discussed in the previous chapters) and ii) the *Poincare shape transition*, a rapid shape change from elongated oblate to octupole alike (see [Maj10]). For example, in the below figure (Fig. 45) it is displayed the free energy surfaces predicted for  $^{142}\text{Ba}$  for different values of angular momentum. As can be seen, the Jacobi shapes, which start emerging around  $I = 76 \hbar$ , are followed by the Poincare shapes from  $I = 88 \hbar$  (very close to the fission limit which in  $^{142}\text{Ba}$  is expected to be near  $I = 100 \hbar$ ).

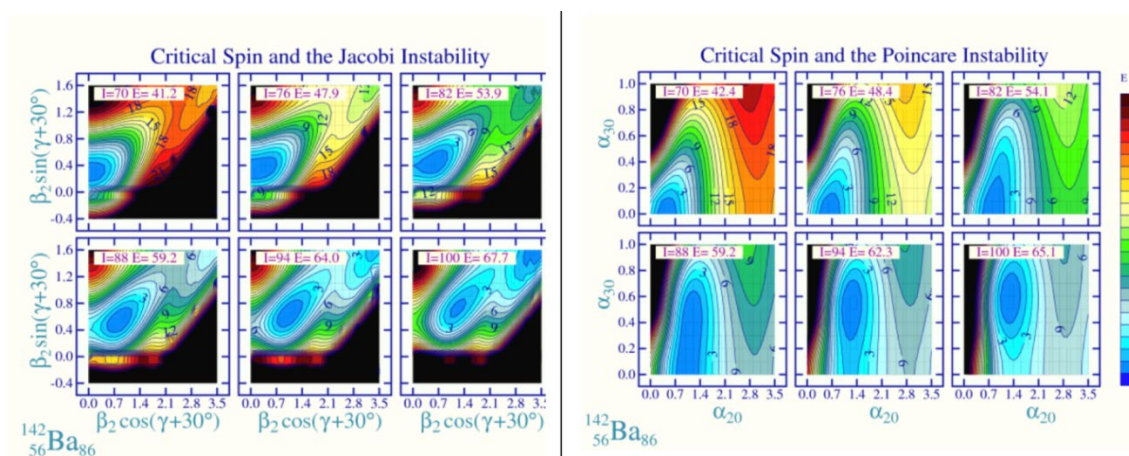

Figure 45. Free energy surfaces for  $^{142}\text{Ba}$  in the space defined by quadrupole deformation parameters (left) and in the space defined by quadrupole and octupole deformation parameters (right) [Maz20].

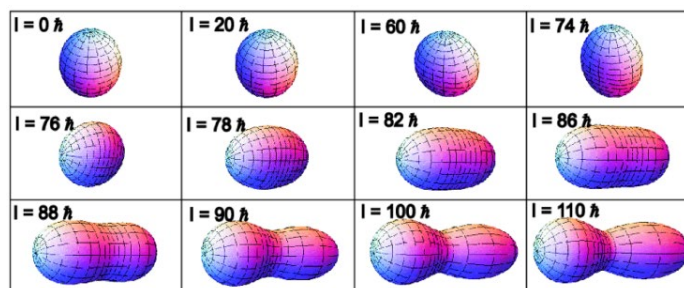

Figure 46. Equilibrium shapes of  $^{142}\text{Ba}$  for different values of angular momentum [Maz20].

It is well known that the Giant Dipole Resonance couple to the nuclear shape, therefore, the measurement of its gamma decay can provide evidence for such shape transition. Indeed, the Jacobi shape transitions were evidenced experimentally in the mass region 40–50. The Poincare transitions were not yet observed. In fact, as it appears from Fig. 46, the difficulty inherent to the experimental study of the Poincare phenomena is related to the rather narrow spin window needed, to the proximity of the fission limit and to the efficient measurement of high energy gamma rays. Moreover, this phenomenon shall be more pronounced in nuclei with high value of the angular momentum for fission, and this is achievable only in exotic, neutron rich nuclei (such as  $^{142}\text{Ba}$ ), which can be produced in fusion-evaporation reaction with rather intensive radioactive beams to be available at SPIRAL2 or SPES. Therefore, a very accurate and efficient measurement of the nuclear angular momentum (namely, the coincidence fold) together with high efficiency for the measurement of high-energy gamma rays is needed. This is achieved only



using a  $4\pi$  geometry, a large granularity and a large efficiency for the measurement of high-energy gamma rays available in the PARIS compact  $4\pi$

### 3. Study of nuclear viscosity by means of $\gamma$ -ray measurements in fusion-fission

Fission of a hot and rotating compound nucleus (CN) produced in fusion reactions from intermediate to high excitation energy (say,  $E^*$  above 40 MeV), as it is a large-amplitude collective motion, has shown to be a very relevant mechanism to investigate nuclear viscosity (see [Maz17] and references therein). The manifestation of friction on the temporal evolution of a fissioning system is three-fold. In addition to the Kramer's reduction factor of the Bohr and Wheeler transition-state-model prediction, caused by the stochastic nature of dissipation, viscosity slows the collective motion down. That results in a transient time  $\tau_{trans}$  until which the quasi-equilibrium as given by Kramers' formula is established at the fission barrier. Finally, viscous damping affects the saddle-to-scission descent, introducing an additional delay  $\tau_{SS}$ .

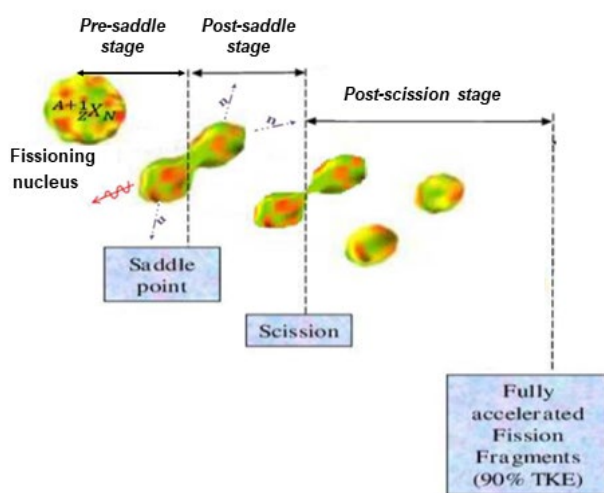

**Figure 47. Schematic picture of the dynamical fission process.**

Experimentally, the fission time scale, and thus the influence of viscosity on it, is most often inferred using the so-called light-particle ( $n$ ,  $p$ , and  $\alpha$ ) and GDR gamma-ray clocks, based on the de-excitation of the system at various steps along the evolution prior scission (see the left panel of the Fig. 47). However, intricate compensation effects between the influence of  $E^*$ ,  $L$  and nuclear shape in determining the particle and GDR rates, as well as uncertain model parameters, make the conclusion controversial, and the fission time scale extracted, respectively, by the neutron and GDR clocks differs by about one order of magnitude depending on the excitation energy [Pau94].

To discriminate between various influences, the experimental knowledge of the CN entry point in the  $(E^*, L)$  phase space is crucial; it will permit to constrain model parameters, and thereby unfold the effect of viscosity on the pre- and post-saddle stages. Measuring the GDR decay properties of the fissioning system is particularly relevant, since they depend rather straightforwardly not only on  $E^*$  and  $L$ , but also on the "local" shape of the system along the evolution, making the constraints for models even more severe.

In the aforementioned investigation, the necessary tight sorting of the GDR properties according to excitation energy and angular momentum along the decay of the CN can be done, respectively, with the accurate measure of the energy sum  $E_\gamma$  and gamma-ray multiplicity  $M_\gamma$ . The gain in efficiency and granularity provided by the PARIS array, when enhanced with more cells in the minicube configuration, will be essential to the success of such studies. Furthermore, the recently demonstrated [Koz20] possibility to extract from PARIS also the neutron multiplicity would be the next straightforward bonus, and would allow to study the consistency between the neutron and GDR clocks with an up-to-date elaborate detector.



#### 4. The Prompt Dipole Mode and the Reaction Dynamics

The Prompt Dipole, or dynamical dipole, consists in the emission of high energy dipole radiation induced by the oscillation of the electric dipole moment created in the process leading to fusion. This dipole photon emission appears in fusion and dissipative collisions after energy and angular momentum are equilibrated. It is related to the charge equilibration process which requires a longer timescale, as it needs a flow of protons/neutrons inside the nucleus [Bra19, Sim01].

This topic is particularly interesting because it provides information on the charge equilibration time and on the symmetry energy of the nuclear matter at densities lower than the saturation value. The dynamical dipole is also considered a possible cooling mechanism to be exploited in the formation of super-heavy elements in hot fusion reactions.

The emission of the prompt dipole radiation is characterised by an energy centroid located approximately at 10 MeV and it can be separated from the contribution of the GDR as the prompt dipole radiation is emitted only during the equilibration of the system. One can isolate it by comparing the E1 yield of two different reactions leading to the same compound nucleus, at the same excitation energy and spin: one (symmetric) employing target and projectile with similar N/Z, and one (asymmetric) with projectile and target with very different N/Z. The dynamical dipole emission has been investigated only in a rather limited number of reactions using combinations of stable projectiles and targets (e.g., [Fli96, Pie03, Cor09, Gia14]).

In this context, the yield of the prompt dipole radiation is expected to increase by more than an order of magnitude making use of more and more N/Z asymmetric systems, such as the ones which will be within reach by the use of radioactive neutron-rich beams. By employing radioactive beams, it will also be possible to perform a systematic study of the dynamic dipole emission, as the same composite system will be accessible by using many more target-projectile combinations than can be achieved with stable ones. As an example, by producing the same compound nucleus  $^{172}\text{Yb}$  with different projectile-target combinations (e.g.,  $^{132}\text{Sn} + ^{40}\text{Ca}$ ,  $^{77}\text{Ni} + ^{95}\text{Mo}$ ,  $^{140}\text{Xe} + ^{32}\text{S}$ ,  $^{94}\text{Kr} + ^{78}\text{Se}$ ,  $^{124}\text{Sn} + ^{48}\text{Ca}$ ) one expects to observe an increase in the prompt dipole yield of more than an order of magnitude (see Fig. 48).

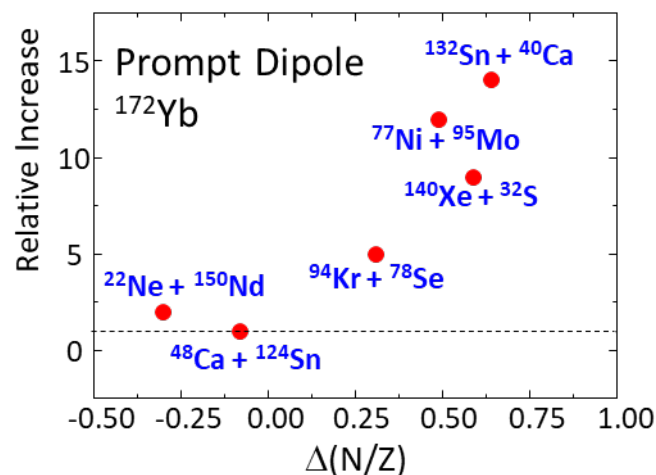

Figure 48: The yield of the prompt dipole in different fusion reactions leading to the compound nucleus  $^{172}\text{Yb}$ . The yield is expected to increase significantly with the N/Z asymmetry of the projectile-target system. In the figure, the increase of the yield is estimated relative to the value obtained for the case  $^{48}\text{Ca} + ^{124}\text{Sn}$ .

The study of the dynamic dipole requires a  $\gamma$ -ray spectrometer with a high absolute full energy peak efficiency (in the 5 – 15 MeV range) and with neutron-discrimination capabilities, such as a  $4\pi$  scintillator array based on large volume detectors. Therefore, The PARIS array, in its mini- $4\pi$  geometry, could represent an ideal setup for this kind of studies.

## **5. Measurement of capture gamma-rays by Summing Technique using a $4\pi$ configuration of PARIS**

The measurement of gamma-rays from capture reactions is one of the major techniques to determine cross sections and astrophysical S factors for reactions related to nuclear astrophysics. Both proton and neutron capture reactions are crucially important to understand nucleosynthesis of isotopes from different regions of the nuclear chart and in different astrophysical sites. The determination of the capture cross section is simple if the excited state decays directly to the ground state [Mazum20]. However, in general, the decay to the ground state happens through multiple pathways leading to production of multiple gamma-rays. This leads to the experimental complication of full scale, discrete gamma-ray spectroscopy and demand a large array of high resolution (HPGe) detectors [Wei83]. The experimental complication can be simplified by detecting all the gamma-rays and summing them to extract the total excitation energy from the sum peak in the gamma-ray spectrum. This kind of summing technique is applied by using sum-spectrometers (generally of large volume NaI (TI) detectors) to record the total gamma-ray spectrum [Har20]. The capture cross sections, resonances etc. at different beam energies are determined from the counts under the sum peak. A typical PARIS configuration, comprised of nearly 150 phoswich crystals and completely surrounding the target, would result in a very fine sum spectrometer and may prove to be ideal for measurements related to nuclear astrophysics. A large number of very important measurements involving  $(p,\gamma)$  or  $(n,\gamma)$  capture reactions relevant to different astrophysical processes, namely, p, rp, r, s [Ber16] etc. can be carried out using the PARIS array of around 150 phoswiches as a sum-spectrometer. In the Fig. 42 it is displayed the PARIS absolute full energy peak efficiency in the case of only one incident gamma ray and in the case that all the energy deposited in PARIS is summed. Therefore, a ‘compact’ PARIS array in a  $4\pi$  geometry can be successfully used as a granular and very efficient sum spectrometer.

## SUMMARY

PARIS is a collaborative international project to construct and operate a novel array of scintillator detectors in a phoswich design. The front part is composed of an advanced scintillator materials, namely  $\text{LaBr}_3:\text{Ce}$  or  $\text{CeBr}_3$ . The design performances of PARIS are superior to any other existing scintillator calorimeter array.

The single PARIS unit is a phoswich detector composed of a  $\text{LaBr}_3:\text{Ce}$  or  $\text{CeBr}_3$  frontal part ( $2'' \times 2'' \times 2''$ ) connected to a long back part ( $2'' \times 2'' \times 6''$ ) composed by a NaI crystal. The signal from the Lanthanum Halide crystal and from the NaI one can be well separated using either an analog unit called LABRPRO (see Fig. 4 of the Introduction) or using a fast digitizer (see Fig. 5 of the Introduction). Depending upon the physics case, the PARIS phoswiches can be arranged into a wall, a cluster (composed of 9 phoswiches) or a  $\mu$ cluster (composed of 4 phoswiches) geometry.

The major strength of the PARIS array lies in its intrinsic efficiency for high energy gamma rays (see Fig. 2 of the Introduction) and in its sub-nanosecond time resolution. An important feature of the PARIS array is provided by the possibility to perform “internal” and “external” addback to increase the detection efficiency. The add-back algorithms have been developed during the test experiments performed in different laboratories using the PARIS phoswiches in specific geometries. The PARIS array can additionally measure neutrons (see Fig. 10 of the Introduction) and low energy ( $0.1 < E < 4$  MeV) gamma rays. The energy resolution of the total array is also quite good. Depending on the number of the used phoswiches (at the moment PARIS has more than 75 phoswiches) PARIS is expected to have a large granularity (as compared to other arrays of this type) and therefore can provide a fold measurement which is a very good estimation of the gamma multiplicity of the event (see Fig. 3 of the Introduction).

In its actual state (end of 2020) the PARIS array (8 clusters) can cover an angle between  $1\pi$  and  $2\pi$  depending on the distance between the phoswiches and the target. PARIS can be used in a standalone mode or coupled with other detectors, like for example AGATA or VAMOS. In this last case, the PARIS data acquisition should be able to communicate with that of auxiliary detectors.

PARIS is designed to enhance the physics program of the hosting laboratories. In this White Book there are reports from seven different international laboratories (GANIL, ALTO, LNL, CCB, PLF, GSI and JINR) concerning the hosting of PARIS, and the physics cases which can be tackled with it in such laboratories in the next 4–5 years. The physics cases have been selected to provide examples of experiments where the PARIS array, in the present phase (8 clusters), is needed for the success of the measurements.

However, many of these presented physics cases would greatly profit if a larger number of PARIS clusters were available. One could also expect that new physics cases, in which the highest efficiency, larger solid angle or larger granularity is crucial, would be proposed if PARIS covered larger solid angle,  $3\pi$  or even  $4\pi$ . Therefore, the extension of PARIS to next phases (for example 16 clusters or the  $4\pi$  minicube) has to be seriously considered in the near future by the PARIS Collaboration (see the previous section).

The PARIS array is constantly developing, so to learn about the latest status please check the PARIS web page [paris.ifj.edu.pl](http://paris.ifj.edu.pl). It has to be also stressed, that PARIS is an open collaboration and, therefore, any new institution willing to join or any laboratory interested to host PARIS are very welcome.

## References

- [Azh20] A.K. Azhibekov, et al., [Phys. Atom. Nuclei 83, 93–100 \(2020\)](#).
- [Bab19] F. Babra, [Phys. Rev. C 100, 054308 \(2019\)](#).
- [Bec84] F.A. Beck, Proc. Conf. on Instrum. for Heavy Ion Nuclear Research Nucl. Sci. Research Conf. Series vol 7 Ed. Schapira D. Harwood, pp 129–45, (1984).
- [Ber16] C.A. Bertulani and T. Kajino, [Prog. Part. Nucl. Phys. 89, 56 \(2016\)](#).
- [Ber81] F.E. Bertrand, et al., [Phys. Lett. B 103, 326 \(1981\)](#).
- [Bog14] S. Bogomolov, et al., Proc. of RUPAC-2014, Obninsk, Russia, 2014, THPSC47, p.p. 432–434.
- [Boh75] A. Bohr and B.R. Mottelson, Nuclear Structure (Benjamin, New York, 1975), vol. 2.
- [Bou17] E. Bouquerel, et al., Proceedings IPAC2017, Copenhagen, Denmark.
- [Bri98] N.J. O’Brien, R. Wadsworth, et al. [Phys. Rev. C 58, 3212 \(1998\)](#).
- [Bra19] A. Bracco, et al., [Prog. Part. Nucl. Phys. 106, 360 \(2019\)](#).
- [Bra01] A. Bracco, et al., [Nucl. Phys. A 682, 449c \(2001\)](#), and references therein.
- [Cer15] S. Ceruti, et al., [Phys. Rev. Lett. 115, 222502 \(2015\)](#).
- [Cie20] M. Ciemala, et al., [Phys. Rev. C 101, 021303\(R\) \(2020\)](#).
- [Cie21] M. Ciemala, private communication.
- [Ciep20] N. Cieplicka-Oryńczak, et al., [Acta Phys. Pol. B Proc. Suppl. 13, 389 \(2020\)](#).
- [Cor09] A. Corsi, et al., [Phys. Lett. B 679, 197 \(2009\)](#).
- [Dat05] V.M. Datar, et al. [Phys. Rev. Lett. 94, 122502 \(2005\)](#).
- [Dat13] V.M. Datar, et al, [Phys. Rev. Lett. 111, 062502 \(2013\)](#).
- [Dey18] B. Dey, et al., [Phys. Rev. C 97, 014317 \(2018\)](#).
- [Fli96] S. Flibotte, et al., [Phys. Rev. Lett. 77, 1448 \(1996\)](#).
- [Fom08] A.S. Fomichev, et al., JINR Commun. E13-2008-168 (2008), Dubna.
- [Fom10] A.S. Fomichev, et al., [Acta Phys. Pol. B 41, 475-480 \(2010\)](#).
- [Fom12] A.S. Fomichev, et al., [J. Phys. Conf. Ser. 337, 012025 \(2012\)](#).
- [Gia13] A. Giaz, et al., [Nucl. Instrum. Meth. A 729, 910 \(2013\)](#).
- [Gia14] A. Giaz, et al., [Phys. Rev. C 90, 014609 \(2014\)](#).
- [Goo96] A.L. Goodman and T. Jin, [Nucl. Phys. A 611, 139 \(1996\)](#).
- [Gos16] C. Gosh, V. Nanal, et al., [J. Instrum. 11 P05023 \(2016\)](#).
- [Gre07] J. Grębosz, [Comput. Phys. Commun. 176, 251 \(2007\)](#).
- [Gul95] G. Gulbekian, et al., Proc. of 14 Int. Conf. On Cyclotrons and Their Applications, Cape Town, South Africa, 1995, B-15, p.p. 95-98.
- [Gul11] G. Gulbekyan, et al., Proc. of IPAC-2011, San-Sebastian, Spain, 2011, WEPS082, p.p. 2700-2702.
- [Gul16] G. Gulbekian, et al., Proc. of Int. Conf. On Cyclotrons and Their Applications, Zurich, Switzerland, 2016, THP25, p.p. 363-365.
- [Hab93] M. Kicińska-Habior, et al., [Phys. Lett. B 308, 225 \(1993\)](#).
- [Had16] K. Hadyńska-Klęk, et al., [Phys. Rev. Lett. 117, 062501 \(2016\)](#).
- [Har20] S. Harissopulos, et al., [Eur. Phys. J. A 9, 479 \(2000\)](#).
- [Hof96] P. Hoff, et al., [Phys. Rev. Lett. 77, 1020 \(1996\)](#).
- [Jaa83] M. Jääskeläinen, et al., [Nucl. Instrum. Meth. A 204, 385 \(1983\)](#).
- [Jon10] K.L. Jones, et al., [Nature 465, 454 \(2010\)](#).
- [Kal18] I.V. Kalagin, et al., Proc. of 14th Int. Conf. on Heavy Ion Accelerator Lanzhou, China, 2018, MOOXA01, p.p. 23-27, doi:10.18429/JACoW-HIAT2018-MOOXA01, ISBN: 978-3-95450-203-5.
- [Ker73] A. Kerek, et al., [Phys. Lett. B 252, 44 \(1973\)](#).
- [Kmi20] M. Kmiecik, private communication.

- [Kor20] W. Korten, W., A. Atac, D. Beaumel, et al., [Eur. Phys. J. A 56, 137 \(2020\)](#).
- [Koz20] E. Kozulin, et al., [Eur. Phys. J. A 56, 6 \(2020\)](#).
- [Las21] Md.S.R. Laskar, et al., TIFR Digital Data Acquisition Software for Nuclear Structure Studies, (in preparation).
- [LRP2010] [NUPECC Long Range Plan 2010 \(www.nupecc.org\)](#).
- [Maj92] A. Maj, et al., [Phys. Lett. B 291, 385 \(1992\)](#).
- [Maj94] A. Maj, et al., [Nucl. Phys. A 571, 185 \(1994\)](#).
- [Maj04] A. Maj, et al., [Nucl. Phys. A 731, 319 \(2004\)](#).
- [Maj10] A. Maj, et al., [Int. J. Mod. Phys. E19, 532 \(2010\)](#).
- [Mas16] V.A. Maslov, et al., [Journal of Physics: Conference Series 724, 012033 \(2016\)](#).
- [Maz17] K. Mazurek, et al., [Eur. Phys. J. A 53, 79 \(2017\)](#).
- [Maz20] K. Mazurek, J. Dudek, private communication.
- [Mazum20] I. Mazumdar, [J. Astrophys. Astron. 41, 1 \(2020\)](#) and references therein.
- [Met83] V. Metag, et al., (1983) The Darmstadt-Heidelberg-crystal-ball. In: von Oertzen W. (Eds) Detectors in Heavy-Ion Reactions. Lecture Notes in Physics, vol 178. Springer, Berlin, Heidelberg; ([https://doi.org/10.1007/3-540-12001-7\\_251](https://doi.org/10.1007/3-540-12001-7_251)).
- [Mye01] W.D. Myers and W.J. Świątecki, [Acta Phys. Pol. B 32, 1033 \(2001\)](#).
- [Nan18] V. Nanal and B.K. Nayak, Nuclear Physics News, vol 28, issue 4 (2018), 4–10; BARC-TIFR Pelletron Linac Facility; (<https://doi.org/10.1080/10619127.2018.1529512>).
- [New81] J.O. Newton, et al., [Phys. Rev. Lett. 46, 1383 \(1981\)](#).
- [Oko03] J. Okołowicz, M. Płoszajczak, I. Rotter, [Phys. Rep. 375, 271–383 \(2003\)](#).
- [Pal12] R. Palit, et al. [Nucl. Instrum. Meth. A 680, 90 \(2012\)](#).
- [Pan17] D. Pandit, et al., [Phys. Rev. C 95, 034301 \(2017\)](#).
- [Pau94] P. Paul and M. Thoennessen, [Ann. Rev. Part. Sci. 44, 65 \(1994\)](#).
- [Pen19] Yu.E. Penionzhkevich, Yu.G. Sobolev, et al., [Phys. Rev. C 99, 014609 \(2019\)](#).
- [Pie03] D. Pierroutsakou, et al., [Eur. Phys. J. A 17, 71 \(2003\)](#).
- [Qi18] L. Qi, M. Lebois, J.N. Wilson, et al., [Phys. Rev. C 98, 014612 \(2018\)](#).
- [Qi20] L. Qi, C. Schmitt, et al., [Eur. Phys. J. A 56, 98 \(2020\)](#).
- [Rad04] D.C. Radford, et al., [Nucl. Phys. A 746, 83c \(2004\)](#).
- [Reg95] P.G. Regan, G.D. Dracoulis, et al., [Phys. Rev. C 51, 1745 \(1995\)](#).
- [Rod03] A.M. Rodin, et al., [Nucl. Instrum. Meth. B 204, 114–118 \(2003\)](#).
- [Sah12] S. Saha, et al., [Phys. Rev. C 86, 034315 \(2012\)](#).
- [Sah14] S. Saha, et al., [Phys. Rev. C 89, 044315 \(2014\)](#).
- [Sah19] S. Saha, et al., [Phys. Rev. C 99, 054301 \(2019\)](#).
- [Sch13] J. Van Schelt, et al., [Phys. Rev. Lett. 111, 061102 \(2013\)](#).
- [She02] J. Shergur, et al., [Phys. Rev. C 65, 034313 \(2002\)](#).
- [She04] A. Shevchenko, et al., [Phys. Rev. Lett. 93, 122501-1 \(2004\)](#).
- [Sim01] C. Simenel, et al., [Phys. Rev. Lett. 86, 2971 \(2001\)](#).
- [Sin14] P. Singh, et al. [Phys. Rev. C 90, 014306 \(2014\)](#).
- [Siv20] I. Siváček, Yu.E. Penionzhkevich, Yu.G. Sobolev, S.S. Stukalov, [Nucl. Instrum. Meth. A 976, 164255 \(2020\)](#).
- [Sob12a] Yu.G. Sobolev, et al., [Bull. Russ. Acad. Sci. Phys. 76, 952–957 \(2012\)](#).
- [Sob12b] Yu.G. Sobolev, M.P. Ivanov, Yu.E. Penionzhkevich, [Instrum. Exp. Tech. 55 \(6\), 618–623 \(2012\)](#).
- [Sob19] Yu.G. Sobolev, Yu.E. Penionzhkevich, et al., Bull. Russ. Acad. Sci. Phys. 83 (4), 402–410 (2019).
- [Sob20] Yu. G. Sobolev, Yu.E. Penionzhkevich, et al., Bull. Russ. Acad. Sci. Phys. 84 (8), 948–956 (2020).
- [Tin20] C. Tintori, private communication.

- [Wan14] H. Wang, et al., [PTEP 023D02 \(2014\)](#).
- [Was18] B. Wasilewska, PhD thesis, IFJ PAN Kraków 2018.
- [Was19] B. Wasilewska, et al., [Acta Phys. Pol. B 50, 469 \(2019\)](#).
- [Was20] B. Wasilewska, et al., [Acta Phys. Pol. B 51, 677 \(2020\)](#).
- [Was20a] B. Wasilewska, private communication.
- [Wei83] M. Weischer, et al., [Phys. Rev. C 28, 1431 \(1983\)](#).
- [Xia18] J. Xiang, Z.P. Li, et al., [Phys. Rev. C 98, 054308 \(2018\)](#).
- [Yos03] M. Yosoi, et al., [Phys. Lett. B 551, 255 \(2003\)](#).
- [Zie20] M. Ziębliński, private communication.



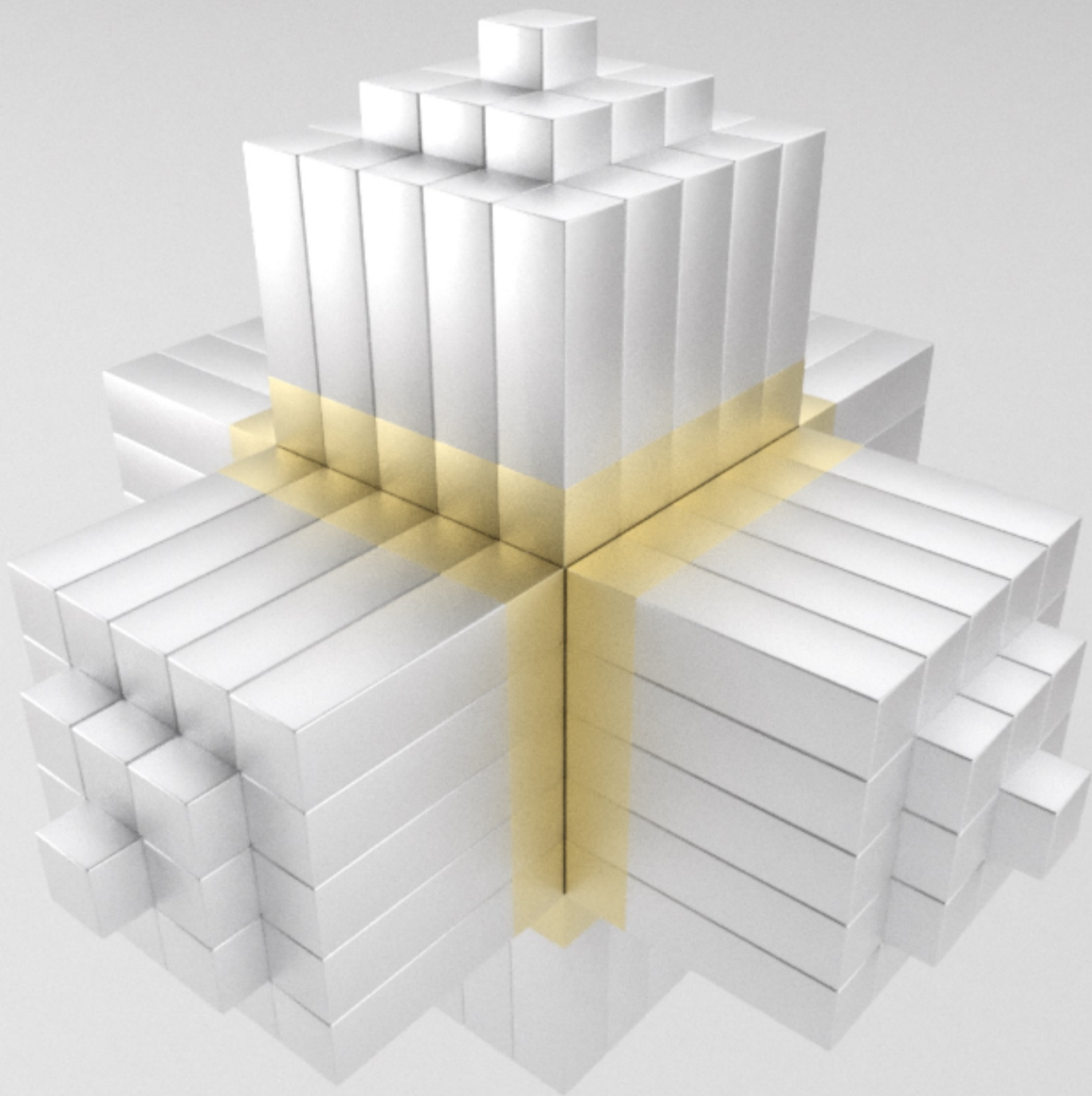

ISBN 978-83-63542-22-1